

BS|ACOUSTICS

Arya Kit



User Manual



Technical specification :

Frequency range	: 44-28000 Hz +/-3 dB
Sensitivity (2.83V / 1m)	: 87.5 dB
Nominal impedance	: 4
Max SPL	: 107 dB
Recommended amplifier	: 50-200W
Cross-over frequency	: 3000 Hz
Speaker type	: 2½-way Floor Stand
Enclosure type	: Bass reflex
Port tuning frequency	: 41 Hz

Drive Units:

- High frequency driver : SB29RDC-C000-4
- Low frequency drivers : 2 x 6" SB17MFC35-8

Cabinet:

18 mm MDF

Dimensions (H x W x D) : 1076 x 195 x 310 mm / 42.36 x 7.68 x 12.2 inch

Net weight (pair):

- Cabinet only : 18.73 kg / 41.29 lb
- Full assembly : 22.54 kg / 49.69 lb

Special Features:

- High quality drivers
- Diffraction optimized cabinet proportions
- Internal bracing to reduce and distribute cabinet vibrations
- Dual vents and slanted internal bottom plate for reduction of standing wave resonances

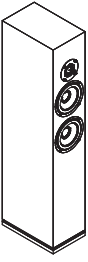

Frequency response

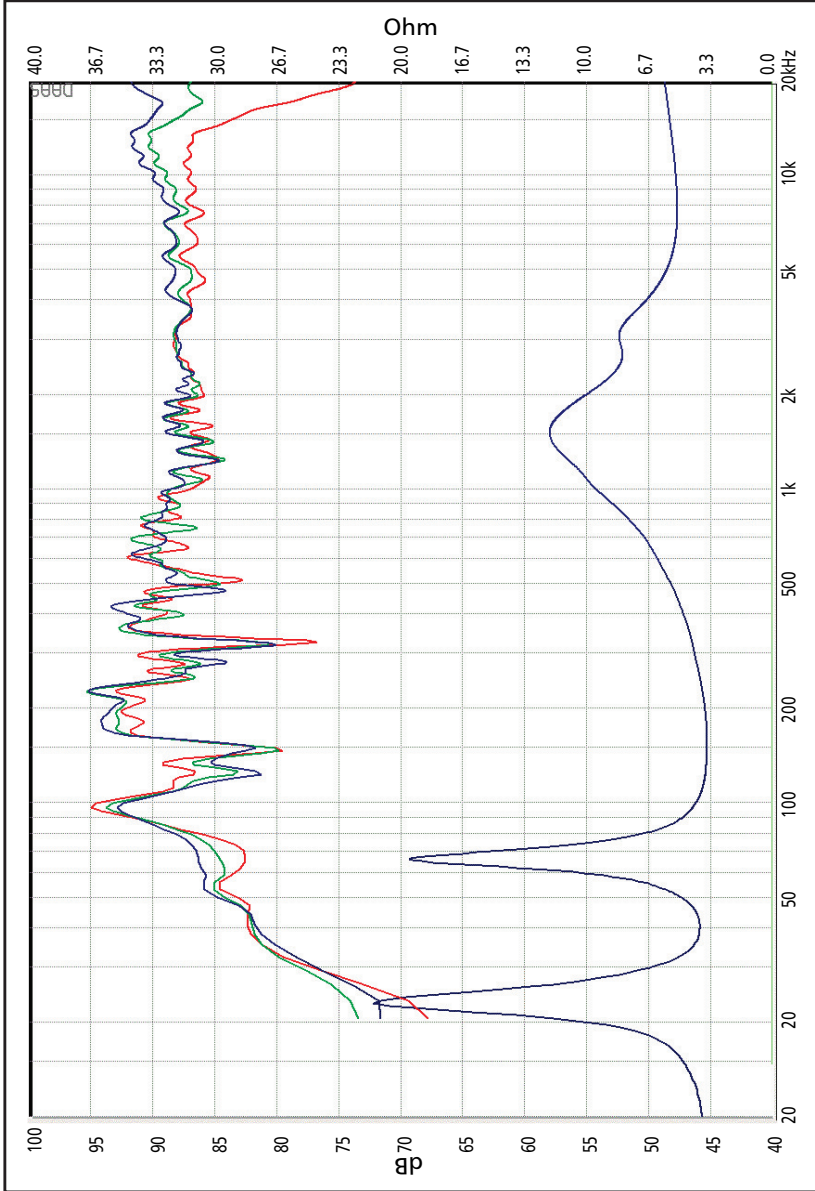

Response Curve :
— (Blue) : on axis — (Green) : 15° off-axis — (Red) : 30° off-axis

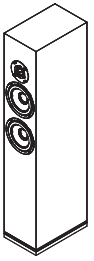

Mechanical drawing (size in mm)

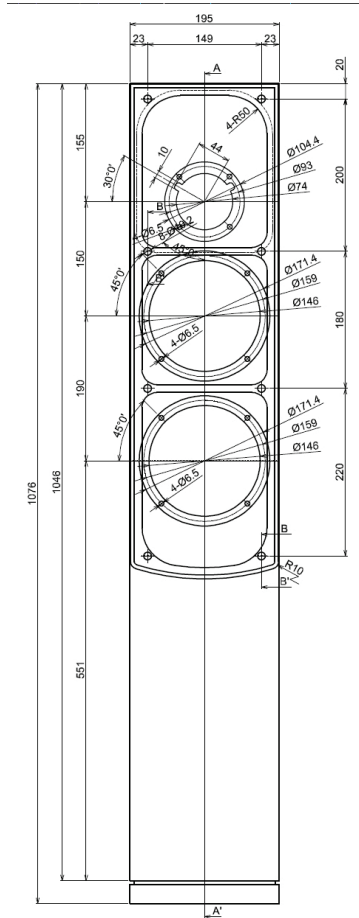

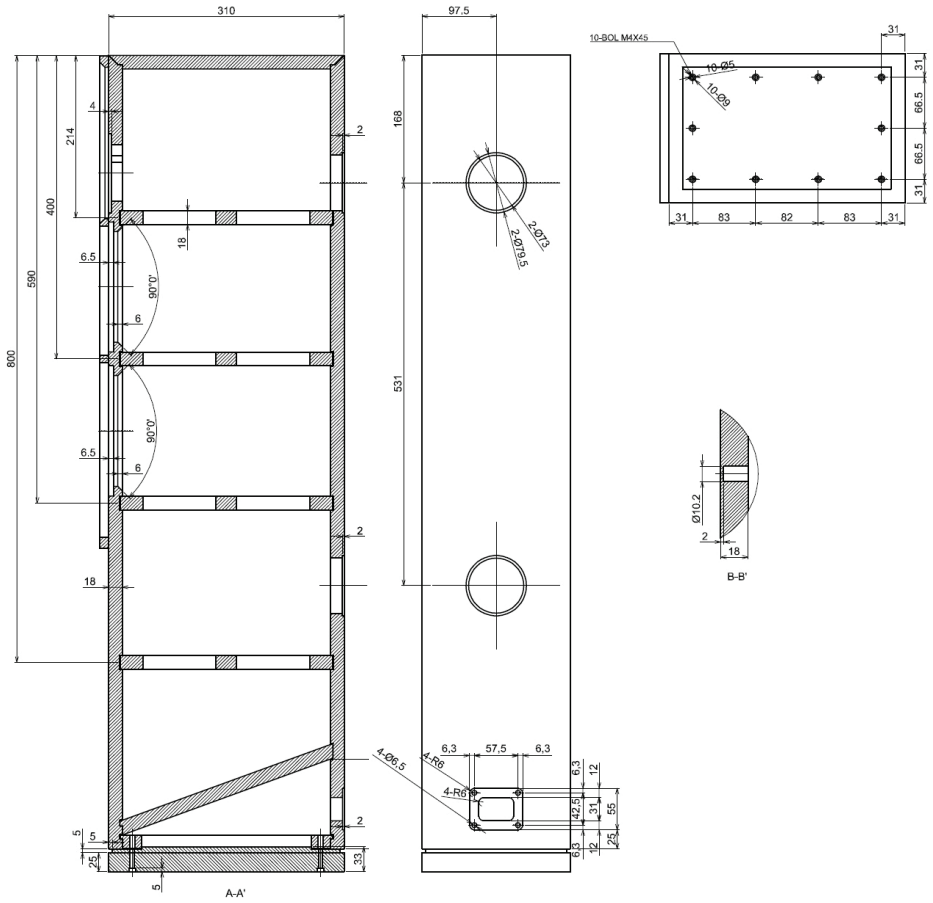
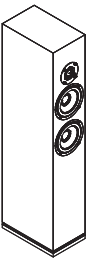

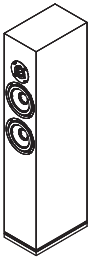

ARYA KIT - EXPLODED VIEW

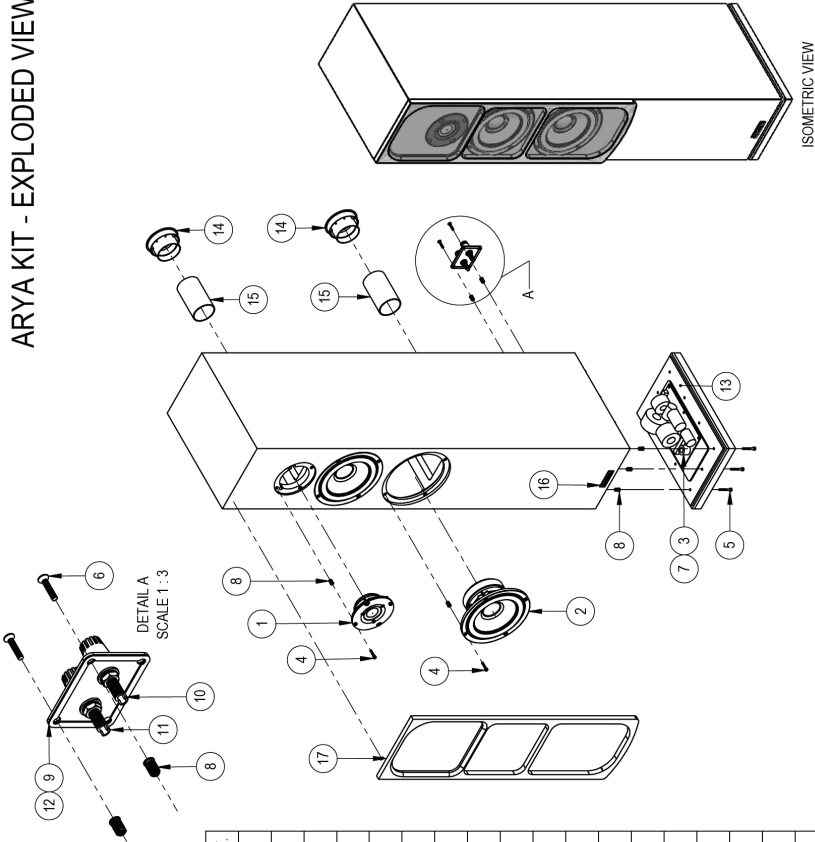

ISOMETRIC VIEW

NO.	PART LIST	QTY
1	SB29RDC-0000-4 (Sold separately)	1
2	6" SB17MFC35-8 (Sold separately)	2
3	Arya Kit Crossover (Sold separately)	1
4	Hex Socket Screw 4x20mm (For driver)	12
5	Hex Socket Screw 4x30mm (For pedestal)	10
6	Countersunk Screw 4X20mm (For terminal plate)	4
7	Wood Screw 4x16mm (From kit crossover)	6
8	Insert Nut M4 (Installed)	26
9	Stainless Steel Terminal Panel	1
10	Binding Post (-) (Black)	1
11	Binding Post (+) (Red)	1
12	Seal Gasket (For terminal plate)	1
13	Seal Gasket (For pedestal)	1
14	Port flare d.50mm (Installed on cabinet)	2
15	Paper tube d.50mm L.90mm (Installed on cabinet)	2
16	Name Plate	1
17	Speaker Grille	1
18	Damping Material (See cut pattern)	1

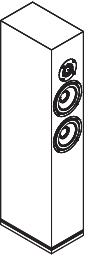

Damping Material Cut Pattern (Size in mm)

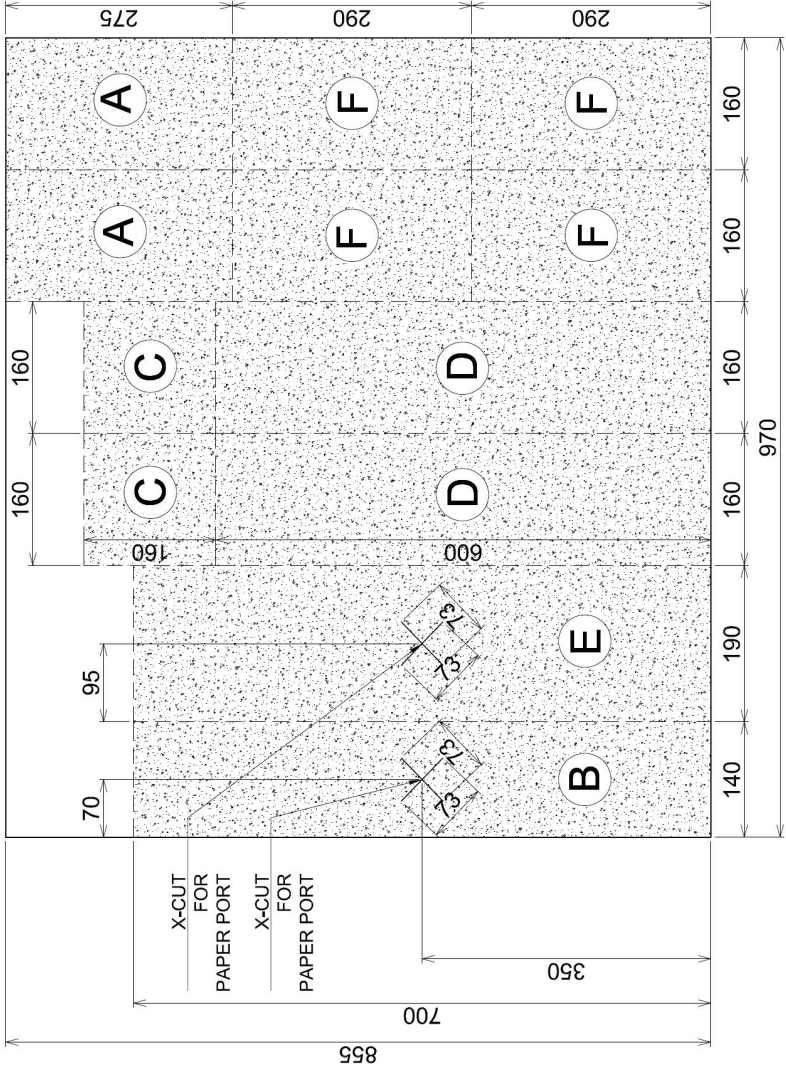

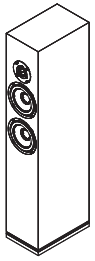

Damping material position (size in mm)

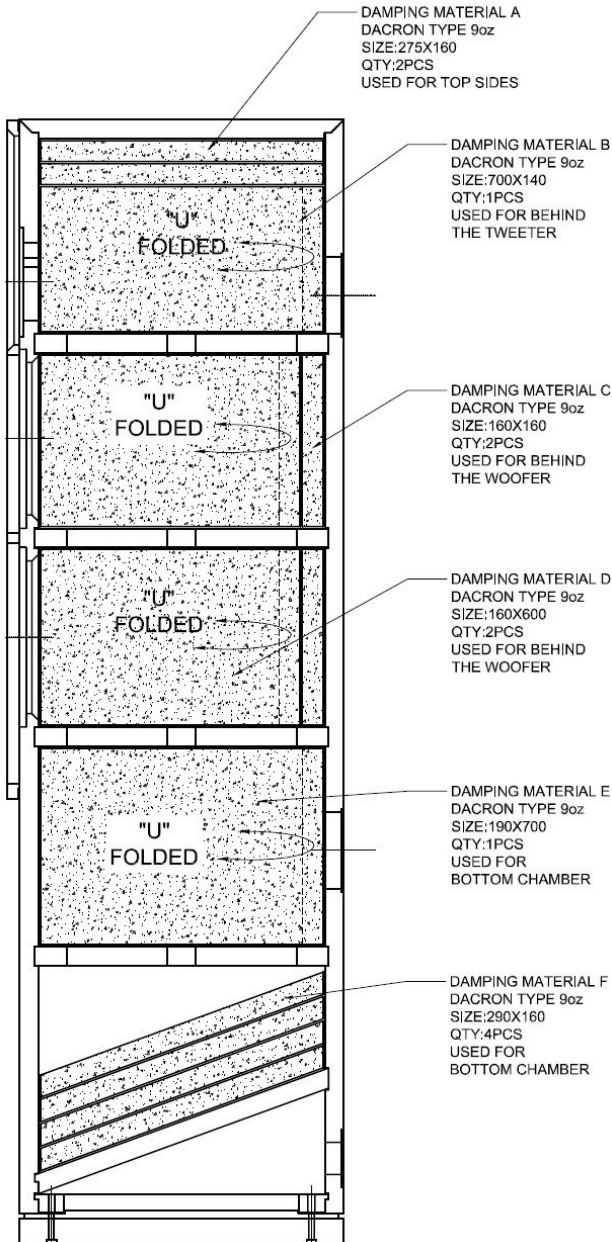

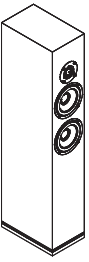

Crossover Schematic

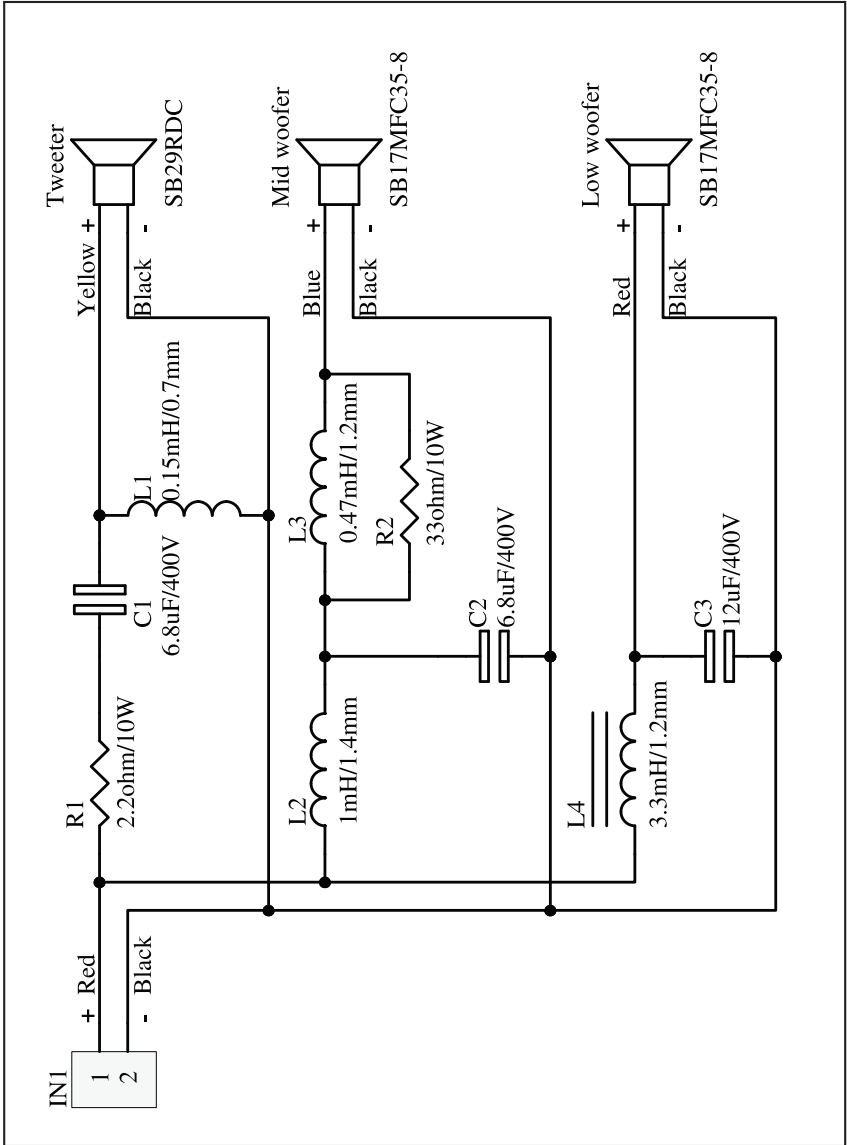

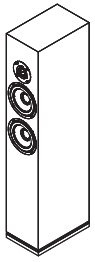

Assembling instruction

Part list (each cabinet):

- High frequency driver SB29RDC-C000-4 (sold separately).....	1 pc
- Low frequency drivers 6" SB17MFC35-8 (sold separately).....	2 pcs
- Arya kit crossover (sold separately)	1 pc
- Hex socket screw M4 x 20mm (for drivers).....	12 pcs
- Hex socket screw M4 x 30mm (for pedestal)	10 pcs
- Countersunk screw M4 x 20mm (for terminal plate)	4 pcs
- Wood screw 4 x 16 mm for crossover (from kit crossover)	6 pcs
- Insert nut M4 (Installed on cabinet)	26 pcs
- Stainless Terminal plate	1 pc
- Binding post	1 pair
- Seal gasket (for terminal plate)	1 pc
- Seal gasket (for pedestal, installed on cabinet)	1 pc
- Port flare (installed on cabinet)	2 pcs
- Port paper tube (installed on cabinet)	2 pcs
- Damping	1 pc
- Name plate	1 pc
- Speaker grill	1 pc

Tools needed:

- Hex key 3mm size (for driver and pedestal screw)
- Hex key 2.5mm size (for terminal plate screw)
- Philips screwdriver no. 2 (for crossover screw)
- Soldering iron + tin (for soldering input wire to terminal)
- Multipurpose glue (for attaching the damping and sealing the wire hole)

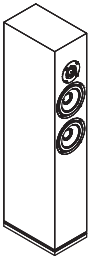

1. Take out the cabinet from the packaging and take out the raw damping material from the cabinet



2. Cut the raw damping material to 12 pcs of damping according to the cutting pattern diagram

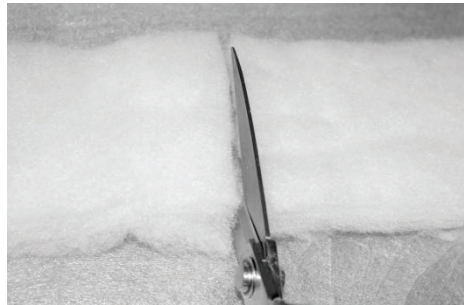

3. Place each damping into the cabinet according to position diagram. Put little glue if needed to hold the damping.

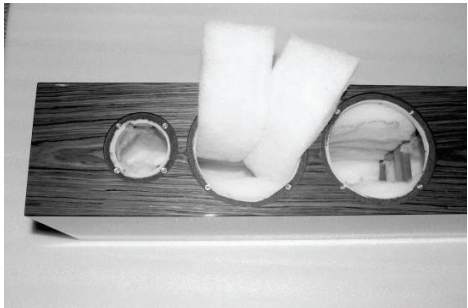

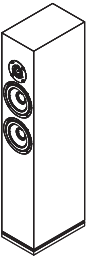

4. Detach the pedestal by loosen the four screws in each corner.

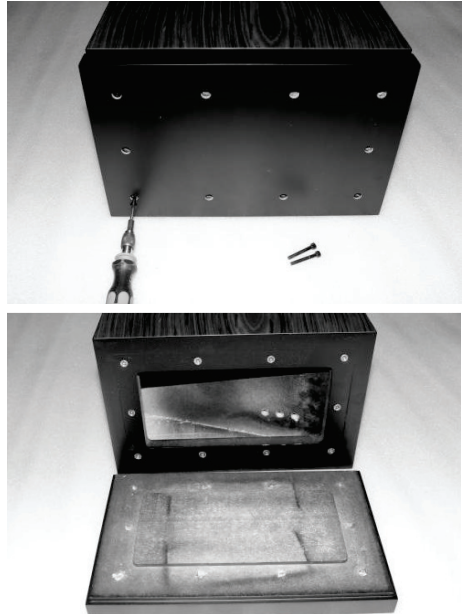

5. Place the crossover on the pedestal, then put the input cable towards the rear terminal side and the speaker wire towards the front panel.

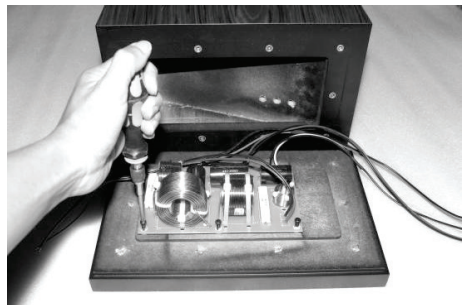

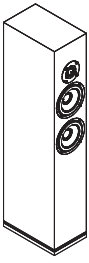

6. Pass the three pair of the speaker wire through each hole in the bottom panel of the cabinet.

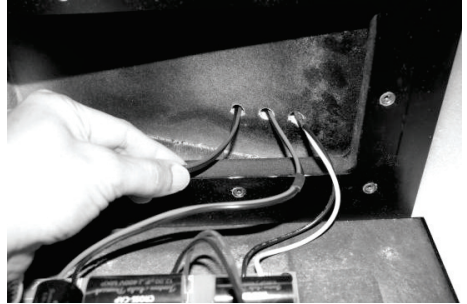

7. Seal all the cable holes with hot melt glue

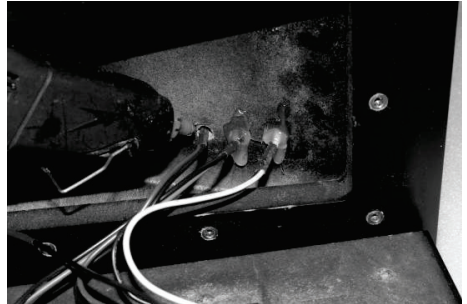

8. Pull out the input cable through the terminal hole then solder it to the binding post terminal

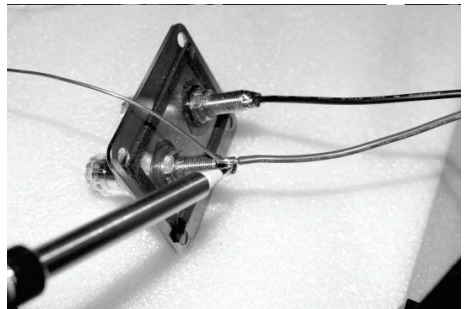

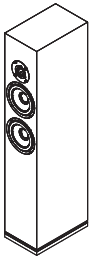

9. Mount the terminal panel into the terminal holes at the back side



10. Mount the pedestal back to the cabinet then tighten it by tightening all 12 screws



11. Pull the three pair of cables through the holes in each cabinet bracing

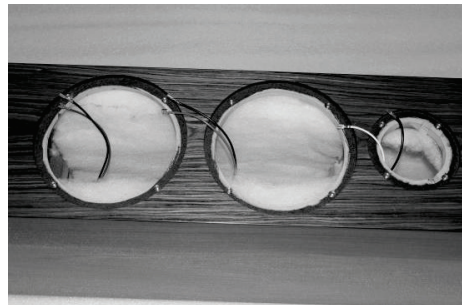

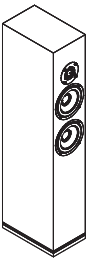

12. Hook up the cable to the woofer and tweeter terminal

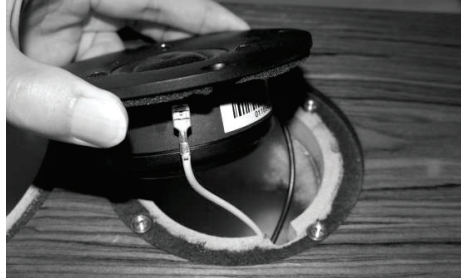

13. Mount the driver to the cabinet and screw them

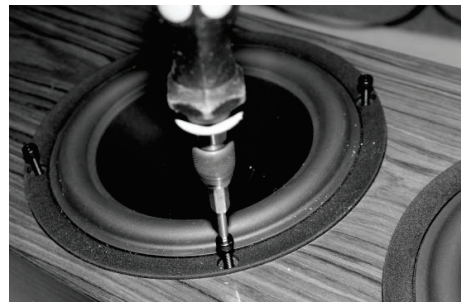
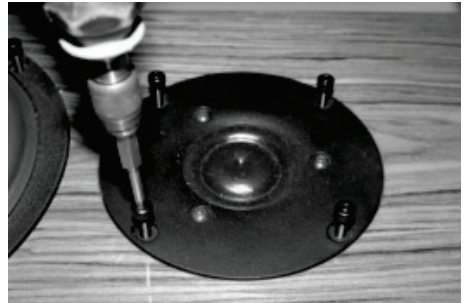

Find Us On



www.sbacoustics.com
