

USER MANUAL

KBU-55, KBU-56, KBU-57, KBU-328 SERIES BEVERAGE COOLER

LAE controller from Italy



KBU-55



KBU-56



KBU-328

COMPRESSOR BEVERAGE COOLER



CONTENTS

CONGRATULATIONS

Congratulations and thank you for choosing our KingsBottle Beverage Coolers . We are sure you will find your new appliance a pleasure to use . Before you installing and operating the Beverage Cooler, we recommend that you read through the relevant sections of this manual, which provides a description of your Beverage Cooler and its functions .

To avoid the risks that are always present when you use an electric appliance, it is important that the appliance is installed correctly and that you read the safety instructions carefully to avoid misuse and hazards .

We recommend that you keep this instruction booklet for future reference and pass it on to any future owners .

After unpacking the appliance, please check it is not damaged . If in doubt, do not use the appliance but contact us or your local customer care centre

TABLE OF CONTENTS

| CHAPTER | CONTENTS | PAGE |
|-----------|--|------|
| Part I | Important Safety & Pre-Use Instructions | 3 |
| Part II | Diagram & Description of Beverage Cooler | 4 |
| Part III | Installation Instructions | 5-6 |
| Part IV | Operating Your Beverage Cooler | 7-11 |
| Part V | Layout & Storage | 12 |
| Part VI | Care and Maintenance | 13 |
| Part VII | Troubleshooting Guide | 14 |
| Part VIII | Technical Data | 15 |
| Part IX | Warranty Information | 16 |

PART I IMPORTANT SAFETY INSTRUCTIONS

Please read the user manual carefully and store in a handy place for later reference . The symbols you will see in this booklet have these meanings:



This symbol indicates information concerning your personal safety



This symbol indicates information on how to avoid damaging the appliance



This symbol indicates tips and information about use of the appliance



This symbol indicates tips and information about economical and ecological use of the appliance



TO REDUCE THE RISK OF FIRE, ELECTRICAL SHOCK, OR INJURY WHEN USING YOUR APPLIANCE, FOLLOW THESE BASIC PRECAUTIONS:

1. Read all instructions before using the Beverage Cooler.
2. DANGER or WARNING: Risk of child entrapment. Child entrapment and suffocation are not only problems of the past. Junked or abandoned appliances are still dangerous... even if they will "just sit in the garage for a few days".
3. Before you throw away your old Beverage Cooler:
 - Take off the door.
 - Leave the Shelves in pieces so that children may not climb inside easily.
4. Never allow children to operate, play with, or crawl inside the appliance.
5. Never clean appliance parts with flammable fluids. The fumes can create a fire hazard or explosion.
6. Do not store in the vicinity of any other appliance. Do not store near gasoline or any other flammable vapors. The fumes can create a fire hazard or explosion.



1. The cellar must be plugged into its own dedicated 110-115V, 50/60Hz AC electrical outlet .
2. The plug must be accessible when the cellar is in position.
3. It is essential the power point is properly earthed to ground . Consult a qualified electrician if you are unsure .

4. Don't use extension cords or adapter plugs with this cellar .
5. If the power cord is damaged, have it replaced by a qualified service technician .
6. Unplug the cellar before cleaning it, or changing the light bulb to avoid electric shock .
7. Never unplug the cellar by pulling the electrical cord as this may damage it. Grip the plug firmly and pull straight out .
8. Choose a location for your cellar that isn't too cold . The ambient room temperature should be above 50°F .
9. Stand your cellar in a dry place – avoid areas of high moisture or humidity .
10. Don't put the cellar in frosty or unprotected areas like a garage or on the verandah .
11. Keep the cellar out of direct sunlight .
12. Don't locate the cellar near stoves, fires or heaters .
13. When installed correctly, your cellar should:
 - Have adequate space at the back and sides for air circulation.
 - Be aligned to the surrounding cupboards .
 - Have doors that will self-close from a partially open position
14. Please inspect and clean the filter in front venting grill every month. Failure to clean will void the warranty and increase the running costs.

BEFORE USING YOUR BEVERAGE COOLER

1. Remove the exterior and interior packing.
2. Before connecting the Beverage Cooler to the power source, let it stand upright for approximately 24 hours. This will reduce the possibility of a malfunction in the cooling system from handling during transportation.
3. Clean the interior surface with lukewarm water using a soft cloth.

FEATURES

PART II DIAGRAM & DESCRIPTION OF BEVERAGE COOLER

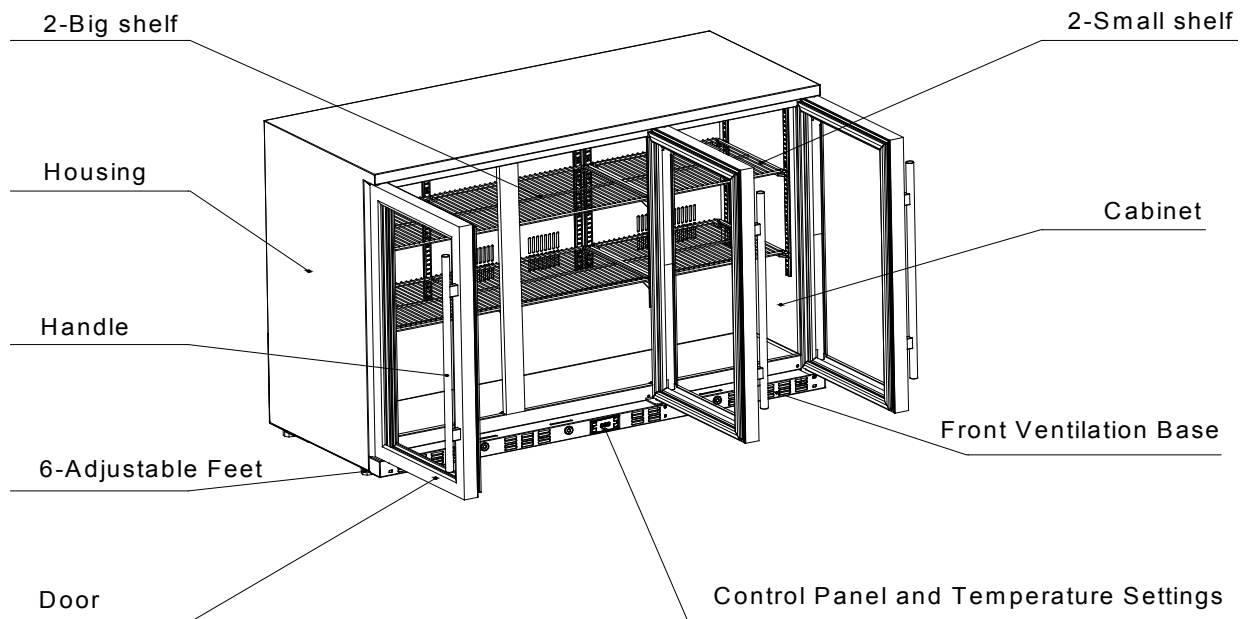
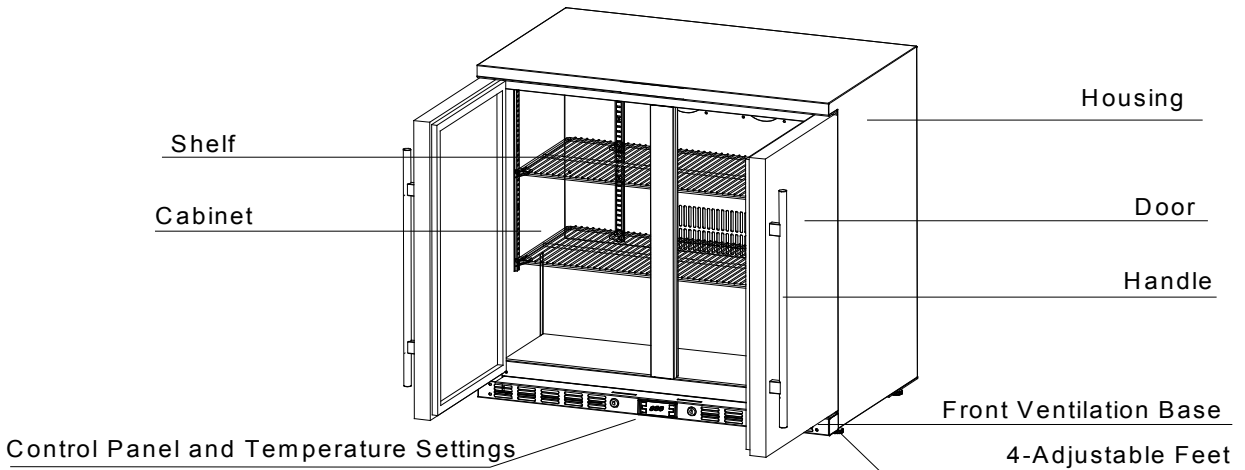
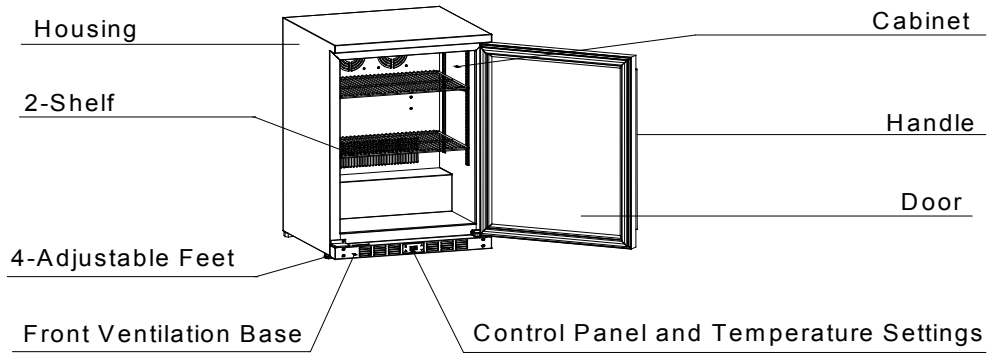

INSTALLATION

PART III INSTALLATION INSTRUCTIONS

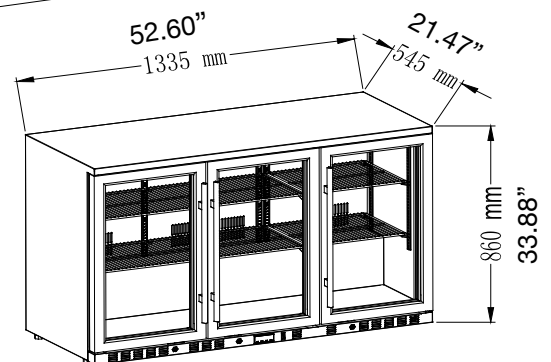
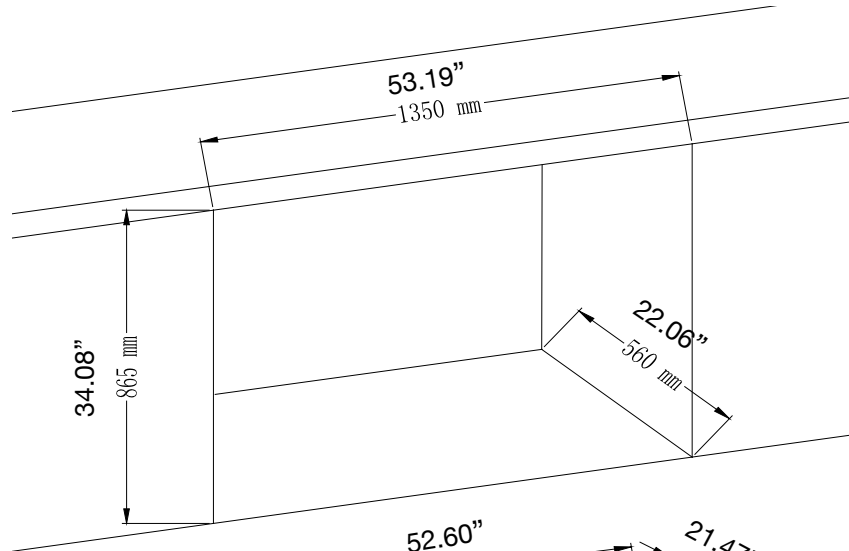
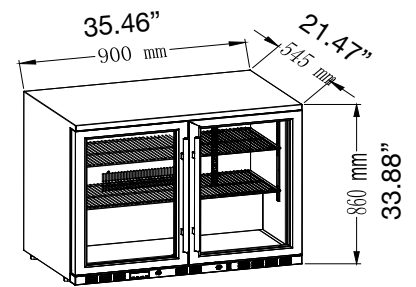
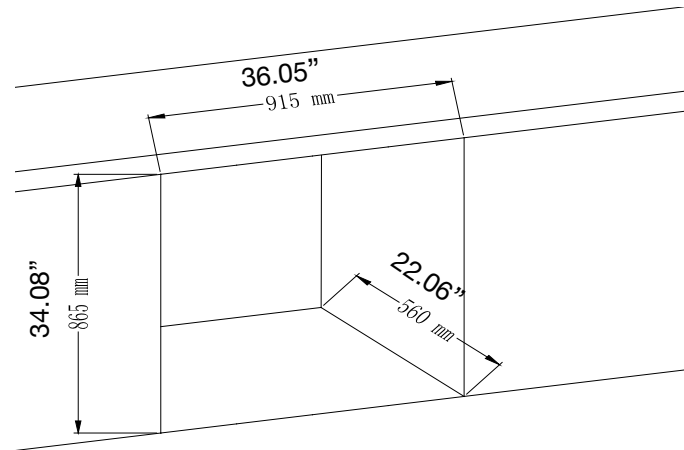
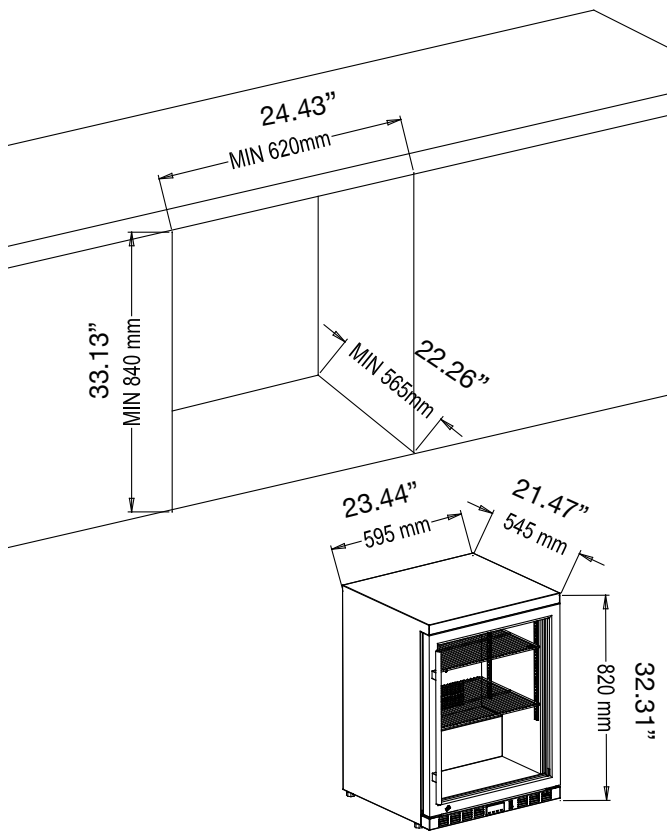

Installing unit into cavity

- ◆ Unit is designed to be Fully Built Into cavity, no ventilation is required.
- ◆ If units on hardwood floor we recommend a rubber mat under unit and some polystyrene or sound proofing material on rear cavity wall to help a little deaden noise.
- ◆ Leave at least a 0.40-0.6" (10-15 mm) shadow line around unit and 2" (50mm) at rear minimum to allow for door swings and electrical plug.
- ◆ Just use common sense, place out of sunlight, direct weather and away from heating appliances.
- ◆ Make sure that installation allows for unit to be removed if required, as condenser will need periodic cleaning and also to allow for servicing in the event of break down.

COMPRESSOR BEVERAGE COOLER



INSTALLATION

PART III INSTALLATION INSTRUCTIONS

A. GENERAL INSTALLATION INSTRUCTIONS

1. This appliance is designed for both free standing and 100% built-in (fully recessed) installation.
2. Place your Beverage Cooler on a flat, solid floor that is strong enough to support it when it is fully loaded. To level your Beverage Cooler, adjust the leveling leg at the bottom of the Beverage Cooler
3. When moving your Beverage Cooler, please do not incline it more than 45 degrees.
4. Locate the Beverage Cooler away from direct sunlight and sources of heat (stove, heater, radiator, etc.). Direct sunlight and heat sources may increase electrical consumption. Extreme cold ambient temperatures may also cause the unit to perform improperly.
5. Avoid locating the unit in damp areas.
6. Plug the Beverage Cooler into an exclusive, properly installed and grounded wall outlet. Do not under any circumstances cut or remove the third (ground) prong from the power cord. Any questions concerning power and/or electrical grounding should be directed to a certified electrician or authorized products service center.

B. INSTALLING YOUR BEVERAGE COOLER

1. Move the appliance into its final position .
2. If the appliance is not tilting back as described earlier, minor adjustments can be made to the leveling legs.
3. Compare the alignment of the appliance to the surrounding cupboard . The top of the appliance should be level from side to side (see diagram below) .

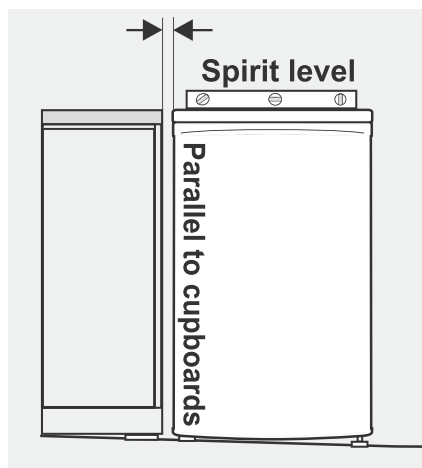

4. If the appliance now rocks from one corner to the opposite rear corner, this means that the floor is uneven. You may need to put some packing under the ridge to the rear of the appliance . You could use thin pieces of solid material such as thin board, vinyl floor tiles or laminate .
5. You may now need to fine tune the installation by repeating steps 2, 3 and 4 .
6. Wipe off any dust that has accumulated during shipping and clean following the directions in Part VIII (Care & Maintenance)
7. Plug the appliance into the power point. Don't use a double adaptor or extension cord .
8. It is recommended that you let the appliance for an hour or two before you put any wine in it . This will confirm that it is operating correctly and make the conditions appropriate for wine storage .

Congratulations! You have successfully installed your cellar/refrigerator/freezer

DOOR LOCK

This unit comes with an optional key lock. The keys are located inside the plastic bag that contains the user manual. To unlock the door, insert the key into the lock and turn counterclockwise. To lock the door, simply reverse the operation making sure the metal pin is engaged completely. Then remove the key and place it in a secure place for safekeeping.

PART IV OPERATING YOUR BEVERAGE COOLER

This Beverage Cooler series comes with LAE controller from Italy, one of the best quality supplier of controllers. Before using your Beverage Cooler, please read this instruction carefully .

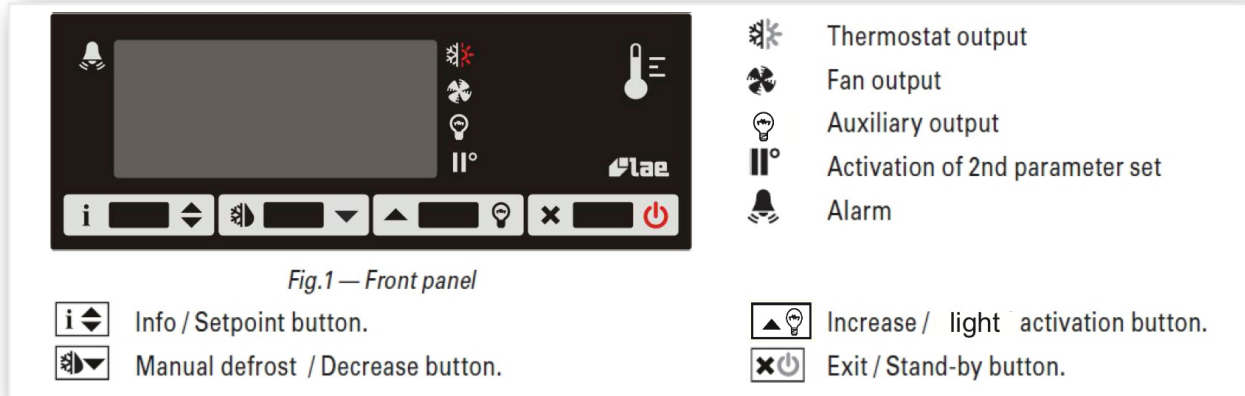

OPERATION

ADJUST TEMPERATURE

- Press button for at least half second to display the setpoint value.
- By keeping button pressed, use button or to set the desired value (adjustment is within the minimum **SPL** and the maximum **SPH** limit).
- When button is released, the new value is stored.

HEATED GLASS FUNCTION

Electrically glass doors are coated with a transparent conductive film on the glass. With the power on, the glass heats to prevent the formation of water droplets on the outer surface. The heated function starts and stops when the compressor operates, unit has 3 x modes (Strong / Off / Weak) so you can adjust if needed as some places are higher in humidity and more subject to condensation. Surface temperature is only 80-93F (27-34°C) , it must be kept away from rain and weather.

DISPLAY

During normal operation, the display shows either the temperature measured or one of the following indications:

| | | | |
|------------|-------------------------|-----------|-----------------------------|
| DEF | Defrost in progress | HI | Room high temperature alarm |
| REC | Recovery after defrost | LO | Room low temperature alarm |
| OFF | Controller in stand-by | E1 | Probe T1 failure |
| CL | Condenser clean warning | E2 | Probe T2 failure |
| DO | Door open alarm | | |

INFO MENU

The information available in this menu is:

| | | | |
|------------|--------------------------------------|------------|--------------------------------------|
| T1 | Instant probe 1 temperature | TLO | Minimum probe 1 temperature recorded |
| T2 | Instant probe 2 temperature | CND | Compressor working weeks |
| THI | Maximum probe 1 temperature recorded | LOC | Keypad state lock |

OPERATION

Most of the following operation is not necessary for daily use, it is only for reference in case required.

Access to menu and information displayed.

- Press and immediately release button 
- With button  or  select the data to be displayed.
- Press button  to display value.
- To exit from the menu, press button  or wait for 10 seconds.

Reset of THI, TLO, CND recordings

- With button  or  select the data to be reset.
- Display the value with button 
- While keeping button  pressed, use button 

STAND-BY

Button , when pressed for 3 seconds, allows the controller to be put on a stand-by or output control to be resumed (with **SB=YES** only).

KEYPAD LOCK

The keypad lock avoids undesired, potentially dangerous operations, which might be attempted when the controllers is operating in a public place. In the **INFO** menu, set parameter **LOC=YES** to inhibit all functions of the buttons. To resume normal operation of keypad, adjust setting so that **LOC=NO**.

SELECTION OF SECOND PARAMETER GROUP

It's possible to select control parameters between two different pre-programmed groups, in order for the fundamental control parameters to be adapted quickly to changing needs. With **IISM=MAN**, changeover from Group I to Group II takes place manually by pressing button  2 seconds. The activation of Group II is signalled by the lighting up of the relevant LED on the controller display. If **IISM=NON**, switchover to group II is inhibited.

DEFROST

Timed defrost. Defrosting starts automatically when necessary time has elapsed to obtain the defrosting frequency set with DFR (IIDF). For example, with DFR=4 defrosting occurs once every 6 hours. The internal timer is set to zero when power is applied to the controller and at each subsequent defrost start. When the controller is put on a standby, the accumulated time count is "frozen" (is not incremented).

Manual defrost. Defrosting may also be induced manually by keeping the button  pressed for 2 seconds.

Defrost type. Once defrost has started, Compressor and Defrost outputs are controlled according to the parameters **DTY** and **OAU**. The AUX output is associated to defrost function with **OAU=DEF** exclusively.











If **FID=YES** the evaporator fans are active all through defrost.

Defrost termination. Defrost lasts as long as time **DTO** but, if the evaporator probe has been enabled (**T2=YES**) and temperature **DLI** is achieved before this time elapses, defrost will be terminated in advance.

Resuming thermostatic cycle. When defrost is over, if **DRN** is greater than 0, all outputs will remain off for **DRN** minutes, in order for the ice to melt completely and the resulting water to drain. Moreover, if probe T2 is active (**T2=YES**), the fans will re-start when the evaporator gets to a temperature lower than **FDD**; Vice versa, if such condition does not occur after 4 minutes following defrost termination, the fans will be switched on anyway.





Caution: if **C-H=HEA** all defrost functions are inhibited; if **DFR=0** the timed defrost function is excluded; during defrost, the high temperature alarm is inhibited.

CONFIGURATION PARAMETERS

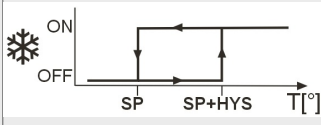
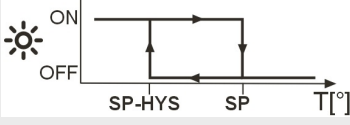
- To get access to the parameter configuration menu, press button  +  for 5 seconds.
- With button  or  select the parameter to be modified.
- Press button  to display the value.
- By keeping button  pressed, use button  or  to set the desired value.
- When button  is released, the newly programmed value is stored and the following parameter is displayed.
- To exit from the setup, press button  or wait for 30 seconds.

OPERATION

| PAR | RANGE | DESCRIPTION | Preset Value |
|------------|---------------------|---|--------------|
| SCL | 1°C; 2°C; °F | Readout scale. 1°C (with INP =SN4 only): measuring range -50/-9.9 ... 19.9/80°C 2°C : measuring range -50 ... 120°C °F : measuring range -55 ... 240°F <i>Caution: upon changing the SCL value, it is then <u>absolutely</u> necessary to re-configure the parameters relevant to the absolute and relative temperatures (SPL, SPH, SP, ALA, AHA, etc..).</i> | °F |
| SPL | -50..SPH | Minimum limit for SP setting. | 32 |
| SPH | SPL.120° | Maximum limit for SP setting. | 46 |
| SP | SPL... SPH | Setpoint (value to be maintained in the room). | 41 |
| C-H | REF; HEA | Refrigerating (REF) or Heating (HEA) control mode. | REF |
| HYS | 1...10° | OFF/ON thermostat differential <div style="display: flex; justify-content: space-around;"> <div style="text-align: center;">  <p>Refrigerating control (C-H=REF)</p> </div> <div style="text-align: center;">  <p>Heating control (C-H=HEA)</p> </div> </div> | 5 |
| CRT | 0...30min | Compressor rest time. The output is switched on again after CRT minutes have elapsed since the previous switchover. We recommend to set CRT =03 with HYS <2.0°. | 6 |
| CT1 | 0...30min | Thermostat output run when probe T1 is faulty. With CT1 =0 the output will always remain OFF. | 3 |
| CT2 | 0...30min | Thermostat output stop when probe T1 is faulty. With CT2 =0 and CT1 >0 the output will always be ON. <i>Example: CT1=4, CT2= 6: In case of probe T1 failure, the compressor will cycle 4 minutes ON and 6 minutes OFF.</i> | 6 |
| CSD | 0..30min | Compressor stop delay after the door has been opened (active only if DS =YES). | 6 |
| DFR | 0... 24(1/24h) | Defrost frequency expressed in cycles/24 hours. | 3 |
| DLI | -50...120° | Defrost end temperature. | 39 |
| DTO | 1...120min | Maximum defrost duration. | 20 |
| DTY | OFF; ELE; GAS | Defrost type OFF: off cycle defrost (Compressor and Heater OFF). ELE: electric defrost* (Compressor OFF and Heater ON). GAS: hot gas defrost* (Compressor and Heater ON). <i>* The defrost output is active if only OAU=DEF.</i> | OFF |
| DRN | 0...30min | Pause after defrost (evaporator drain down time). | 0 |
| DDY | 0...60min | Display during defrost. If DDY =0 during defrost the temperature continues to be displayed. If DDY > 0, during defrost the display shows DEF, and at the end of defrost it shows REC for DDY minutes. | 1 |
| FID | NO/YES | Fans active during defrost. | YES |
| FDD | -50...120° | Evaporator fan re-start temperature after defrost. | 32 |
| FTC | NO/YES | Optimised fan control enabling. With FTC = NO the fans remain on all the time. Fig. 2 Optimised fan control (FTC =YES) | YES |
| FT1 | 0...180sec | Fan stop delay after compressor stop. See Fig. 2. | 180 |
| FT2 | 0...30min | Timed fan stop. With FT2 =0 the fans remain on all the time. | 1 |
| FT3 | 0...30min | Timed fan run. With FT3 =0, and FT2 > 0, the fans remain off all the time. | 1 |

| PAR | RANGE | DESCRIPTION | Preset Value |
|-------------|---|--|--------------|
| ATM | NON; ABS; REL | <p>Alarm threshold management.</p> <p>NON: all temperature alarms are inhibited (<i>the following parameter will be ADO</i>).</p> <p>ABS: the values programmed in ALA and AHA represent the real alarm thresholds.</p> <p>REL: the values programmed in ALR and AHR are alarm differentials referred to SP and SP+HY.</p>  <p>Temperature alarm with relative thresholds, refrigerating control (ATM=REL, CH=REF).</p>  <p>Temperature alarm with relative thresholds, heating control (ATM=REL, CH=HEA).</p> | ABS |
| ALA | -50... 120° | Low temperature alarm threshold. | 32 |
| AHA | -50... 120° | High temperature alarm threshold. | 68 |
| ALR | -12... 0° | Low temperature alarm differential. With ALR=0 the low temperature alarm is excluded. | |
| AHR | 0... 12° | High temperature alarm differential. With AHR=0 the high temperature alarm is excluded. | |
| ATD | 0... 120min | Delay before alarm temperature warning. | 120 |
| ADO | 0... 30min | Delay before door open alarm warning. | 10 |
| ACC | 0...52weeks | Condenser periodic cleaning. When the compressor operation time, expressed in weeks, matches the ACC value programmed, "CL" flashes in the display. With ACC=0 the condenser cleaning warning is disabled. | 0 |
| IISM | NON; MAN; | <p>Switchover mode to second parameter set</p> <p>NON: inhibition to use the second parameter group (<i>the following parameter will be SB</i>).</p> <p>MAN: button  switches the two parameter groups over.</p> | NON |
| IISL | -50...IISH | Minimum limit for IISP setting. | 32 |
| IISH | IISL... 120°C | Maximum limit for IISP setting. | 46 |
| IISP | IISL... IISH | Setpoint in mode 2. | 41 |
| IIHY | 1...10° | OFF/ON differential in mode 2. | 5 |
| IIFT | NO/YES | Optimised fan control enabling in mode 2. | YES |
| IIDF | 0... 24(1/24h) | Defrost frequency expressed in cycles/24 hours in mode 2. | 3 |
| SB | NO/YES | Stand-by button enabling. | YES |
| DS | NO/YES | Door switch input enabling (closed when door is closed). | NO |
| LSM | NON; MAN; DOR | <p>Light control mode</p> <p>NON : light output not controlled.</p> <p>MAN : light output controlled through button  (if OAU=LGT).</p> <p>DOR : light output switched on when door is opened (if OAU=LGT).</p> | MAN |
| OAU | NON; 0-1; DEF; LGT; AL0; AL1 | <p>AUX output operation.</p> <p>NON : output disabled (always off).</p> <p>0-1 : the relay contacts follow the on/standby state of controller.</p> <p>DEF : output programmed for defrost control.</p> <p>LGT : output enabled for light control.</p> <p>AL0 : contacts open when an alarm condition occurs.</p> <p>AL1 : contacts make when an alarm condition occurs.</p> | LGT |
| INP | SN4; ST1 | Temperature sensor selection. With INP = SN4, the probes must be the LAE models SN4...; with INP = ST1, the probes must be the LAE models ST1... | SN4 |
| OS1 | -12.5...12.5°C | Probe T1 offset. | 0 |
| T2 | NO/YES | Probe T2 enabling (evaporator). | YES |
| OS2 | -12.5...12.5°C | Probe T2 offset. | 0 |
| TLD | 1...30 min | Delay for minimum temperature (TLO) and maximum temperature (THI) logging. | 5 |
| SIM | 0...100 | Display slowdown. | 3 |
| ADR | 1...255 | AD3-5 address for PC communication. | 1 |

OPERATION

NOTE:

The desired temperatures may fluctuate depending on whether the interior light is ON or OFF, the ambient temperature, the location of unit and the orientation of the bottles. The display is just a guide, be guided by how cold your drinks are at consumption. Remember units go into defrost mode and this will show a higher display, it's only for small periods and doesn't have time to effect drink temperature. In general once unit has settled it will keep products within 5°F (2°C) of the set temp easily in temperatures up to and beyond 100°F (38°C) .



CAUTION:

1. In the event of a power interruption, all previous temperature settings will be automatically saved and each compartment will return to the previous temperature setting.
2. If the unit is unplugged, loses power, or is turned off, you must wait over 6 minutes before restarting. Within this 6 minutes, compressor protect itself and will not start even power ON again
3. When you use the Beverage Cooler. for the first time or restart the Beverage Cooler after having been shut off for a long time, there will be a few degrees variance between the temperature you select and the one indicated on the LED readout for the first few hours of operation. After a few hours of operation, the temperature will normalize to the displayed temperature.

STORAGE

PART V LAYOUT AND STORAGE

YOUR CABINET WAS DESIGNED TO STORE A MAXIMUM NUMBER OF BOTTLES SECURELY. WE RECOMMEND THAT YOU OBSERVE THE TIPS BELOW TO OPTIMIZE LOADING.

1. Disperse your bottles even so as not to concentrate weight in any one area. Also, be careful that your bottles do not touch either the back of the cabinet or the step at the bottom.
2. Also make sure that bottles are not all grouped together either at the top or bottom of the cabinet.
3. A cooler that is full and has nice allowance for air movement will work more efficiently.
4. Never try to adjust shelf with bottles still on it.

How to use your shelving

- You can put the beer bottles on the shelving any way you like, lay down or upright.
- Max Weight per shelf: 55 lbs (25kgs)
- To adjust shelving, clips can be moved, place 'top' part of clip in first then force bottom part up. If clips seem loose, remove and 'expand the width of opening on clip, this will allow it to fit better.

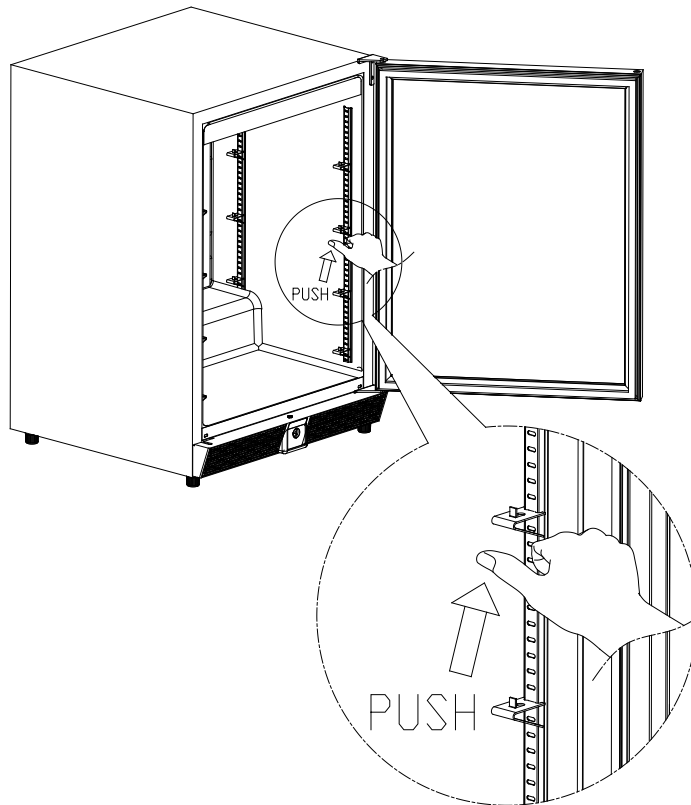

PLEASE NOTE

Before modifying your cabinet's original configuration in any way, be sure to ask your dealer for advice.

REMOVING SHELF

PART VI CARE AND MAINTENANCE

CLEANING YOUR BEVERAGE COOLER



BEFORE CLEANING: Turn off the power, unplug the appliance, and remove all items including all shelves.

- Wash the inside surfaces with warm water and baking soda solution. The solution should be about 2 tablespoons of baking soda with a quart of water.
- Wash the shelves with a mild detergent solution.
- Wring excess water out of the sponge or cloth when cleaning area of the controls, or any electrical parts.
- Wash the outside cabinet with warm water and mild liquid detergent. Rinse well and wipe dry with a clean soft cloth.
- After installation, **we recommend that owners apply a thin layer of Olive Oil with a clean rag, to all exposed Stainless Steel areas.** This should then be polished in and buffed off with another clean rag to a non-oily finish. This process will aid protection against dirt and other corrosive contaminants, by providing a temporary food-safe shield. The Olive Oil layer also makes later polishing and removal of fingerprints easier. This process should be repeated frequently every 3-4 months. ALL stainless steel can rust, it is a myth that stainless steel doesn't rust.

POWER FAILURE

Most power failures are corrected within a few hours and should not affect the temperature of your appliance if you minimize the number of times the door is opened. If the power is going to be off for a longer period of time, you need to take the proper steps to protect your contents.

FILTER CLEANING

PLEASE INSPECT & CLEAN FRONT GRILL FILTER EVERY MONTH

Failure to clean will void the warranty and increase the running costs.

VACATION TIME

Short vacations: You may leave the Beverage Cooler operating during vacations of less than three weeks.

Long vacations: If the appliance will not be used for several months, remove all items and turn off the appliance. Clean and dry the interior thoroughly. To prevent mold growth, leave the door open slightly, blocking it open if necessary.

MOVING YOUR BEVERAGE COOLER

1. Remove all items.
2. Securely tape down all loose items (shelves) inside your appliance.
3. Turn the adjustable leg up to the base to avoid damage.
4. Tape the door shut.
5. Be sure the appliance stays secure in the upright position during transportation. Also protect the outside of the appliance with a blanket or similar item.

ENERGY SAVING TIPS

1. The Beverage Cooler should be located in the coolest area of the room, away from heat producing appliances, and away from direct sunlight. Ventilation at rear also helps a lot with energy usage, so create a positive air flow where possible, although with this range they are designed to be fully built in.
2. When you are not using fridge during weekdays etc. it is recommended to set the temp at a higher level, so set at 47°F (8°C) during periods of non usage, this will not only mean less run time, it also still keeps drinks at a temp that won't be spoiled. It saves energy also which these days is a growing concern for most households.
3. Keep the cooler stocked, an empty cooler will run longer, believe it or not.

REMOVING SHELF

PART VII TROUBLESHOOTING GUIDE

| PROBLEM | POSSIBLE CAUSE | Solution |
|--|---|---|
| Cooler does not operate | <ol style="list-style-type: none"> Not plugged in The appliance is turned OFF at the control panel The circuit breaker tripped or a fuse has blown out | Press ON/OFF Check and make sure the power plug is well connected Ask engineer for help |
| Wine cooler is not cold enough; can not cooling down to preset temp. | Compressor does not start | ask engineer for help, check the connection of compressor |
| | Compressor self-protected and stop operating | Ambient temperature is too high and over 38C degree Air venting is not smooth, check the air duct and make sure it is not blocked Fan operates slowly or faulty and stop operating. Door is not closed completely, or door open for long time Compressor or its components faulty |
| | Fans stop working or low speed operating | Ask engineer for help, power on the cooler, check the fan whether the voltage is normal or not. If the voltage is normal, the fan should be damage |
| | Evaporator ice up | Turn OFF the cooler for one hour, sometimes need also open the door, ice on evaporator will melt. Then turn ON and check again. |
| | Door is not well closed | Check the door lock, shelves, or other objects, make sure door is well closed. Check the sealing rubber, make sure door is well sealed. Check the door hinges, make sure they are not loose |
| | Condenser is dusty | Wash and clean the condenser |
| | Cooling system faulty (Gas leakage or blockage) | Ask engineer for help |
| Compressor start and stop frequently | The door gasket does not seal properly. | Use hair dryer to blow hot air and make the door seal smooth. |
| | The sensor connection is wrong. | According to the wiring diagram and make the correct connection of sensor |
| | The sensor is faulty. | Replace with new sensor |
| | The door is opened too often. | Reduce the times / frequency of door opening. |
| The light does not work. | Not plugged in, or the light button is "OFF". Light itself faulty. | Check and make sure the light button is ON, or ask engineer for help. |
| The Cooler seems to make too much noise. | The stand feet is not leveling, vibrations lead to noise | Adjust the stand feet and assure they are on level. |
| | Pipe hit other objects and lead to noise | Adjust the position of pipe slightly |
| | At the moment of compressor shut down or start, it is normal for the noise from the vibration generated by the internal moving parts due to inertial motion. | nothing is necessary |
| | The ratting noise may come from the flow of the refrigerator, which is normal. As each cycle ends, you may hear gurgling sounds | nothing is necessary |
| The door will not close properly. | Door is blocked by the door lock, shelves, or other objects. | Remove the barrier |
| | Door sealing rubber is deformed | Repair or replace the rubber seal |
| | Door hinges are not loose. | Adjust and fasten the hinges. |
| Ice up | Outlet / suction outlet blockage | Remove the barrier |
| | Fans stop working or low speed operating | Ask engineer for help, power on the cooler, check the fan whether the voltage is normal or not. If the voltage is normal, the fan should be damage |
| | The door gasket does not seal properly; or door is opened too often | Use hair dryer to blow hot air and make the door seal smooth. |
| | Gas leakage or cooling system blockage | Ask engineer for help |
| External cabinet seems too hot | Ambient temperature is too high, or direct sunshine | Using conditions need to be improved |
| | Front grill outlet / suction outlet blockage | Remove the barrier |
| | Fans stop working or low speed operating | Ask engineer for help, power on the cooler, check the fan whether the voltage is normal or not. If the voltage is normal, the fan should be damage |
| Water drop on glass door | Ambient humidity is high | Use a soft cloth to clean the water |
| | Door is opened too often | Reduce the times / frequency of door opening. |
| | The door gasket does not seal properly | Use hair dryer to blow hot air and make the door seal smooth. |
| | Condensation is forming on outside of glass door | Have you turned the 'Heated Door Function' ON? located next to the temperature controller. You shouldn't have condensation on glass with these models if this function is ON. |

TECHNICAL DATA

PART VIII TECHNICAL DATA

| MODEL NO. | KBU-55 | KBU-56 | KBU-328 |
|----------------------------------|---|---|--|
| VOLUME | 123 Liter | 210 Liter | 315 Liter |
| TYPE OF COOLING | compressor with air-circulated fan cooling | compressor with air-circulated fan cooling | compressor with air-circulated fan cooling |
| CLIMATE TYPE | N / ST | N / ST | N / ST |
| ELECTRICITY PROTECTION GRADE | I | I | I |
| NOMINAL VOLTAGE/ FREQUENCY | 110-115V/50-60HZ | 110-115V/50-60HZ | 110-115V/50-60HZ |
| RATED POWER(W) | 170W | 210W | 270W |
| AMBIENT TEMPERATURE | 32 - 100 °F | 32 - 100 °F | 32 - 100 °F |
| TEMPERATURE RANGE | 32-46 °F | 32-46 °F | 32-46 °F |
| Range of inside cabinet humidity | >50%RH | >50%RH | >50%RH |
| NET WEIGHT | 132.3Lbs (60Kgs) | 165.3Lbs (75kgs) | 264.6Lbs (120kgs) |
| GROSS WEIGHT | 143.3Lbs (65Kgs) | 180.7Lbs (82kgs) | 286.6Lbs (130kgs) |
| DIMENSION | 23.4"W x 21.5"D x 32.3"H (595W x545D x820H mm) | 35.4"W x 21.5"D x 33.9"H (900W x545D x860H mm) | 52.6"W x 21.5"D x 33.9"H (1335W X 545D X 860H mm) |

COMPRESSOR BEVERAGE COOLER



WARRANTY

PART IX WARRANTY INFORMATION

Please speak to your Retailer before calling **BTO AMERICA LIMITED** if you did not purchase your Beverage Cooler directly from **BTO AMERICA LIMITED**

Limited warranty – 90 day replacement plan with a free 9 months upgrade, totaling 1 year, on parts and labor from the date of shipment. For customer service, please contact **BTO AMERICA LIMITED** by e-mail (service@kingsbottle.com) .

The limited warranty does not cover: Damage due to such things as accident, misuse, abuse, mishandling, neglect, unauthorized repair or any other cause beyond the control of the seller whether similar or dissimilar to the foregoing. Purchaser understands and acknowledges that the goods sold here are Beverage Coolers, which house wine. Purchaser assumes all the risk of using these units, including risk of spoilage, humidity variations, temperature variations, leaks, fires, water damage, mold, mildew, dryness and similar perils that may occur.



COMPRESSOR BEVERAGE COOLER

