

INSTRUCTION MANUAL

Model:KBU-55-BP, KBU-56-BP, KBU-328-BP



Beverage Cooler

CONTENTS

● MEASUREMENTS	-----	1 ~ 4
● SAFETY PRECAUTIONS	-----	5 ~ 7
● HOW TO USE	-----	8 ~ 9
● CLEANING	-----	9
● IN CASE OF THE FOLLOWING	-----	10
● BEFORE REQUESTING SERVICE	-----	11
● WARRANTY	-----	12

Model	KBU-55-BP	KBU-56-BP	KUB-328-BP
GROSS WEIGHT	91 Lbs	124 Lbs	166 Lbs
NET WEIGHT	83 Lbs	115 Lbs	158 Lbs
EXTERNAL SIZE	23.6W×20.9D×32.9H	35.4W×20.9D×32.9H	53.1W×20.9D×32.9H
MEASUREMENTS	28.3W×24.0D×36.0H	40.2W×24.0D×36.0H	57.9W×24.0D×36.0H

Please read these instructions completely before operating the units.

MEASUREMENTS

KBU-55-BP

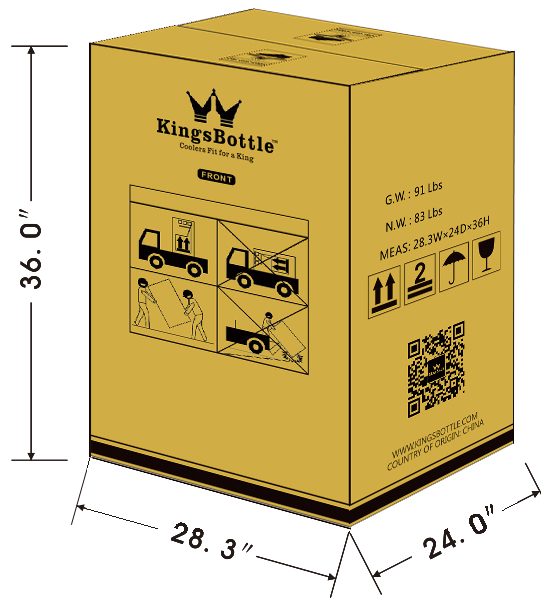

KBU-56-BP

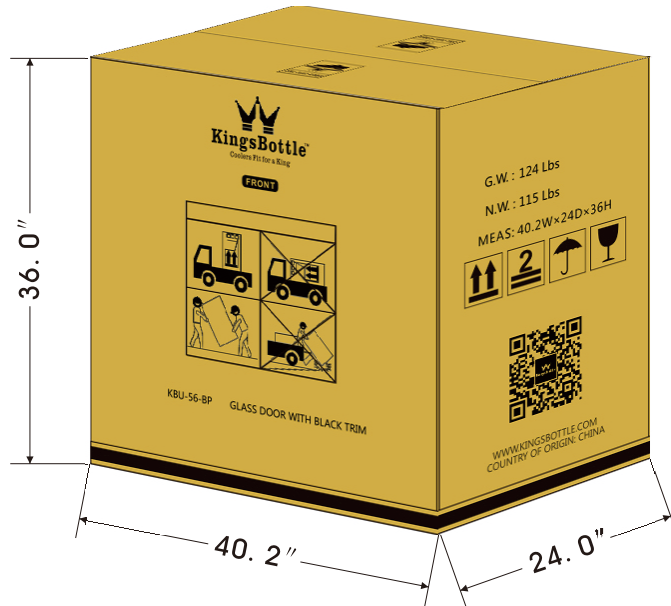

KBU-328-BP

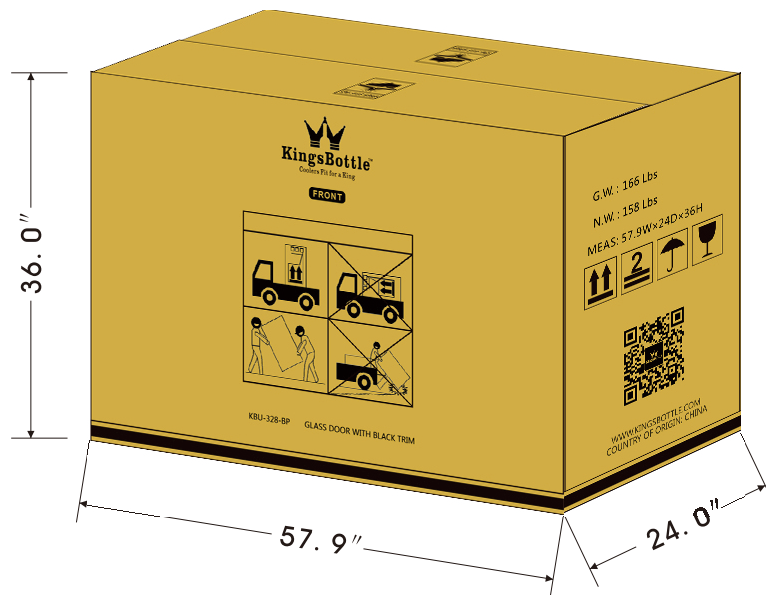

KBU-55-BP

Component Diagrams:

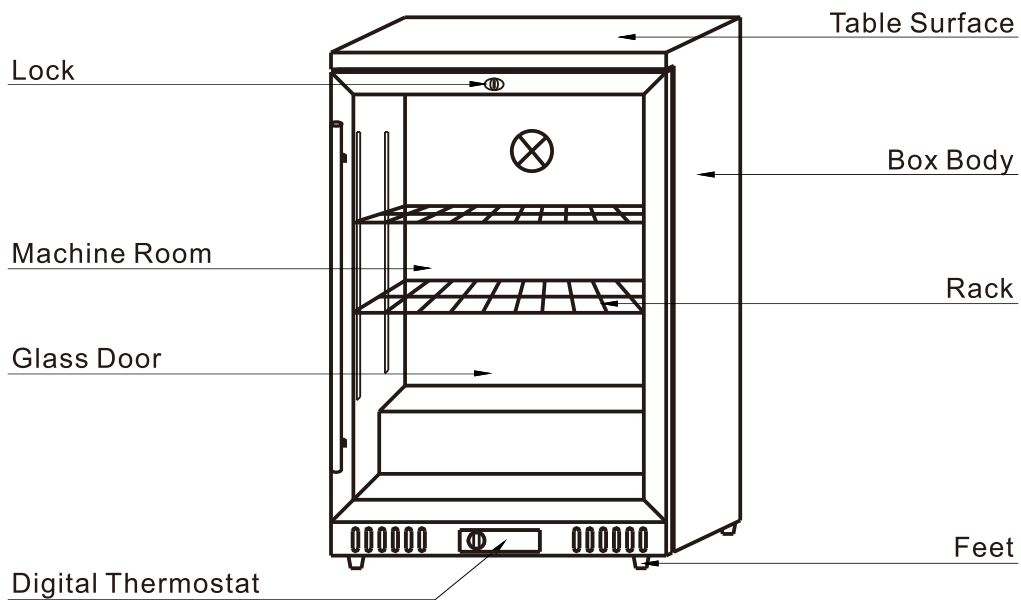

External size:

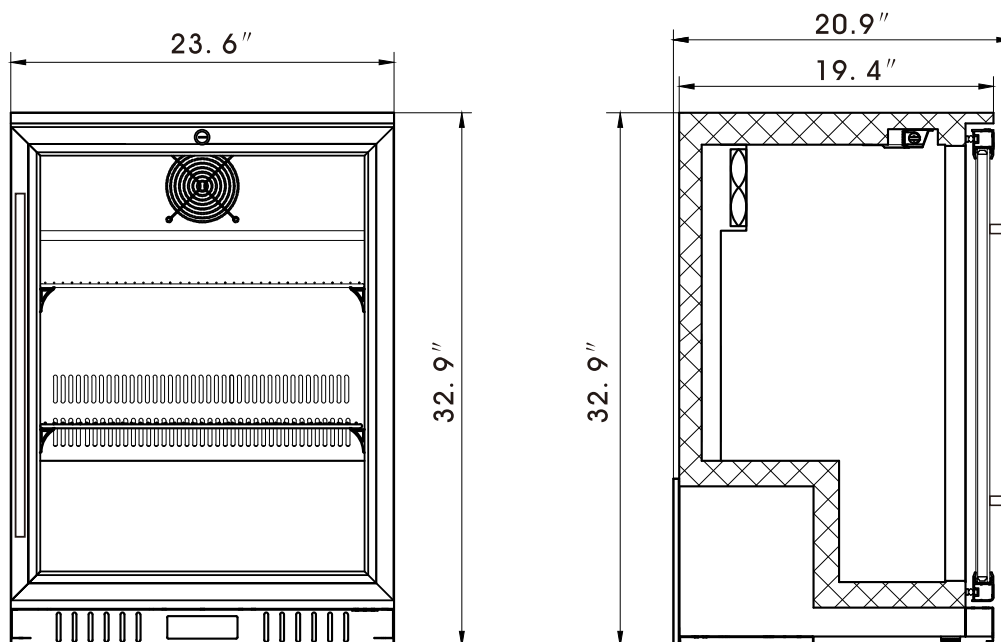

KBU-56-BP

Component Diagrams:

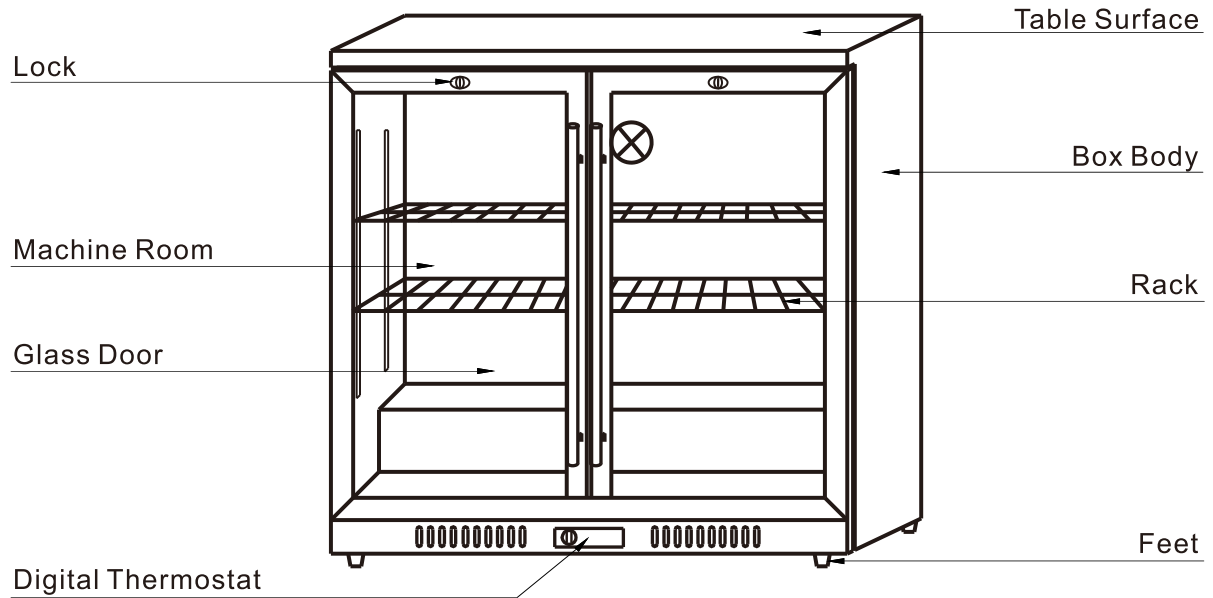

External size:

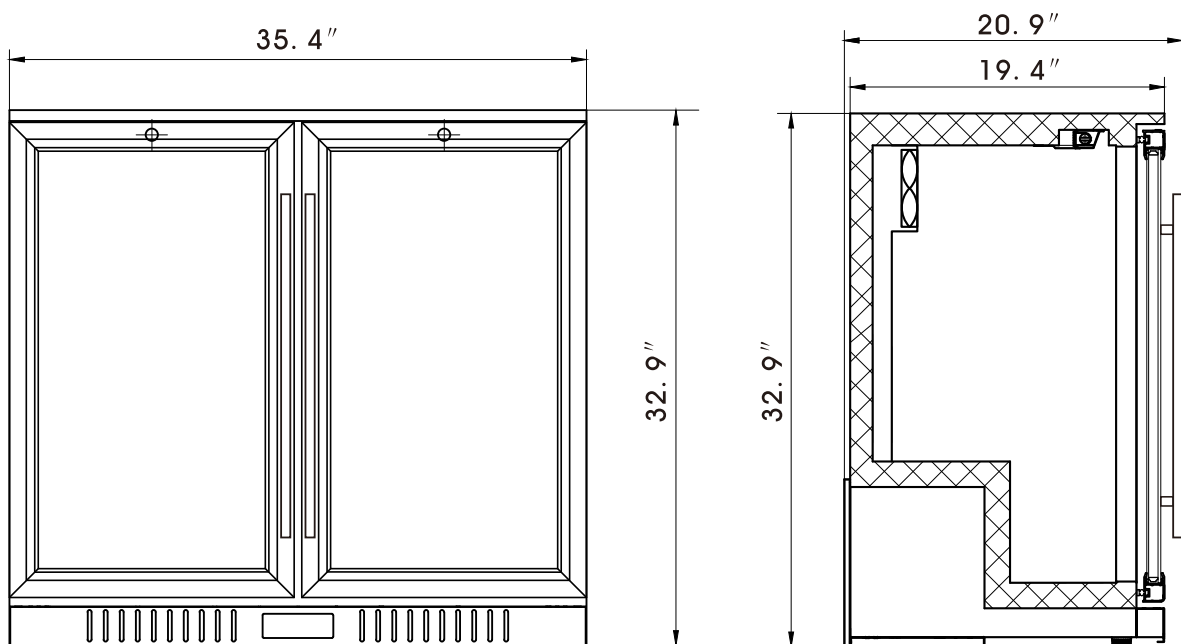

KBU-328-BP

Component Diagrams:

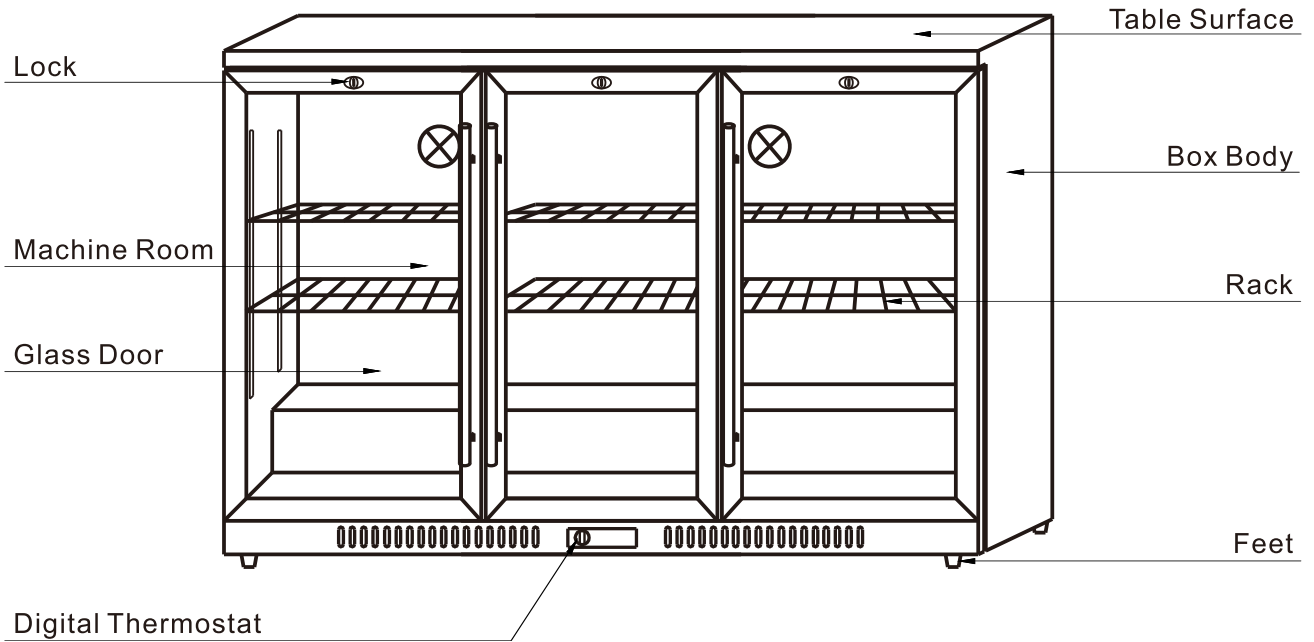

External size:

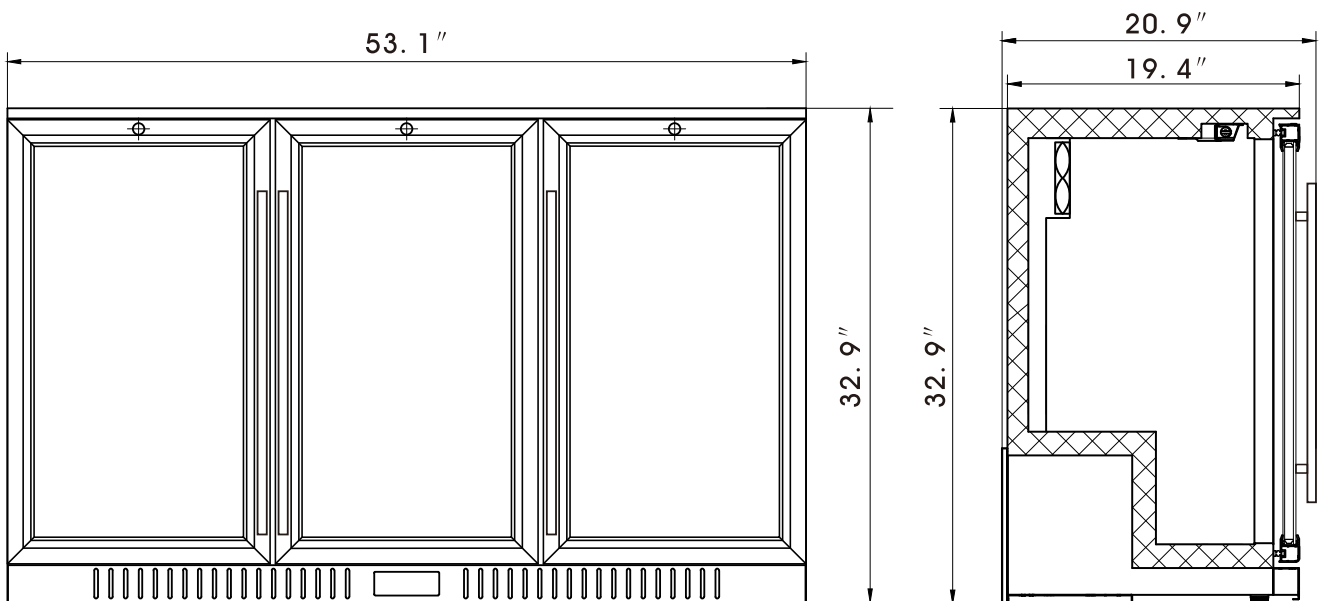

SAFETY PRECAUTIONS

- To ensure proper use, please thoroughly study these SAFETY PRECAUTIONS before operating the Unit.
- The purpose of the safety precautions in this manual is to ensure safe and correct use of the unit to minimize risks that could cause serious damage and injury to you or other persons. The safety precautions are divided into WARNINGS and CAUTIONS. Cases where improper handling of the unit could lead to death or serious injury are listed under the "⚠️WARNING" heading. However, the cases listed under the "⚠️CAUTION" heading could also lead to serious results. To ensure the safety, adhere strictly to both types of safety precautions.
- Keep ventilation openings, in the appliance enclosure or in the built-in structure, clear of obstruction.
- This appliance is not intended for use by persons (including children) with reduced physical, sensory or mental capabilities, or lack of experience and knowledge, unless they have been given supervision or instruction concerning use of the appliance by a person responsible for their safety.
- Children should be supervised to ensure that they do not play with the appliance.
- Do not use mechanical devices or other means to accelerate the defrosting process, other than those recommended by the manufacturer.
- Do not damage the refrigerant circuit.



WARNING Improper handling of the unit could lead to death or serious injury.



CAUTION Improper handling of the unit could lead to serious results depending on the circumstances.

- Text set off by the exclamation mark  contains information that should be strictly adhered to.
- After reading the instruction manual, store it in an easily accessible place where the user(s) of this product can easily find it.

◆ PRECAUTIONS FOR INSTALLATION









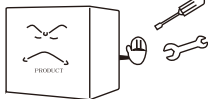

⚠️ WARNING

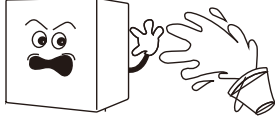

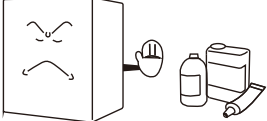
Installation should be performed only by the dealer or a qualified expert. Attempting to install the unit yourself could result in water leakage, refrigerant leakage, electrical shock, or fire.

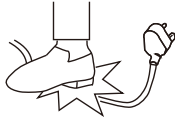
◆ PRECAUTIONS FOR USE

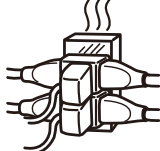
⚠️ WARNING

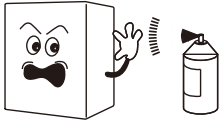
 <p>DONT TAMPER</p> <p>All repairs, disassembly and modifications should be performed only by qualified technicians. Attempting to perform these yourself could result in a fire, malfunction, and injury.</p> 	 <p>ELECTRICAL SHOCK HAZARDS</p> <p>Never splash water directly onto the product or wash with water as short-circuit and electrical leakage could result.</p> 
 <p>DANGER OF EXPLOSION</p> <p>Never put flammable or volatile substances into the unit as explosion and fire could result.</p> 	 <p>PROHIBITED</p> <p>Do not damage, modify, excessively bend, strain, twist or bundle up the power cord. Also, placing heavy objects on the power cord or squeezing it in a tight place could damage it, possibly resulting in electrical shock or fire.</p> 
 <p>PROHIBITED</p> <p>Use a dedicated wall outlet. Do not use extension cords or convenience receptacles as this could result in electrical shock, overheating and a fire.</p> 	 <p>FLAMMABLE</p> <p>Never use flammable spray cans or leave flammable substances near the unit. Sparks from electrical switches could result in explosion and fire.</p> 

SAFETY PRECAUTIONS

⚠️ WARNING



The cooler is intended for storage and display of beverages for sale. Do not use for other purpose than intended as this could adversely affect items placed in the unit.

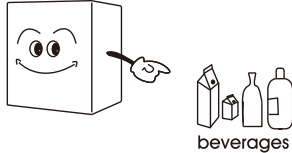

beverages



ROTATING DEVICE

Never attempt to insert fingers, sticks, etc. into the cold air suction outlet as a circulation fan is rotating at high speed inside the outlet. Injury, electrical shock and improper operation could result.

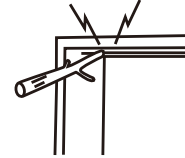

PROHIBITED

For indoor use only. Using the unit in a location exposed to rain could result in electrical leakage and electrical shock.

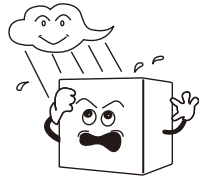

PROHIBITED

Never place heavy objects or items containing water on top of the unit. Objects could fall down and cause injury and spilled water could deteriorate the insulation of electrical components and result in electrical leakage.



Install the unit in a location where the floor is sturdy enough to support the load of the unit. If the floor is not sturdy enough or installation is incorrectly performed, the unit could tip over and falling shelves and products could cause personal injury.

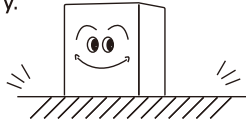

CAUTION AGAINST EXPLOSION

If you find gas leakage, please don't touch the chest freezer, and close gas and open the door for ventilation. Gas leakage could cause explosion, fire, and fire injury.

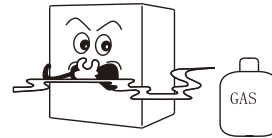

Store the unit in a location where it is not exposed to rain. Using a unit that has been exposed to rain could result in electrical leakage and electrical shock.

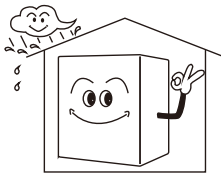

Keep away from hot air sources
Cooling performance is reduced if the unit is placed near heat sources such as hot plates and stoves and if it is exposed to direct sunlight.



Leave disassembly and disposal of the unit to qualified experts.

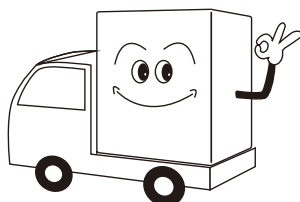

Should the unit need temporary storage, make sure not to store the unit in a location where children play and take precautions so that the door cannot be completely closed. This will minimize the risk that a child becomes trapped inside the compartment.

SAFETY PRECAUTIONS

⚠ WARNING

WELL VENTILATED PLACE

Please make sure there is more than 10cm space between UPRIGHT COOLER and the wall. If there is no space, cooling capacity can drop down.

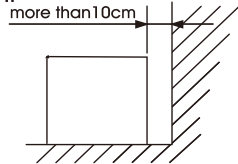

If installation in a damp location is unavoidable, also install an electrical leakage circuit breaker. If no electrical leakage circuit breaker is installed, electrical shock could result.

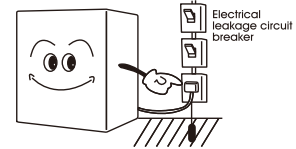

Never hang from the door or climb onto the unit. The unit could tip over or fall and cause material damage or injury.

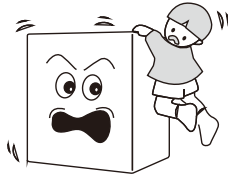

Disconnect the power cord plug from the wall outlet before moving the unit and make sure that the power cord is not damaged during transport. A damaged power cord could result in electrical shock and/or fire.

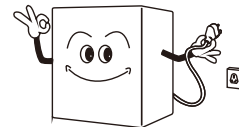

Grasp the handle when closing the door. Holding at other positions could result in pinched fingers and injury.



Do not push hand against or apply excessive force to glass surfaces as the glass could break and cause injury.



When disconnecting the power cord plug from the wall outlet, hold at the plug main body close to the outlet. Pulling the cord could cause wire breakage, possibly resulting in overheating and fire.

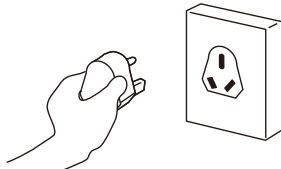

Make sure that the unit does not tip over or fall when it is moved. A falling unit could cause serious injury.

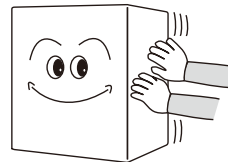

Do not throw items onto the shelves and do not place items totaling more than 65lbs on each shelf. The shelf could fall down, possibly causing injury.



Be sure to attach and secure shelves correctly. An improperly attached shelf could fall down and cause injury.

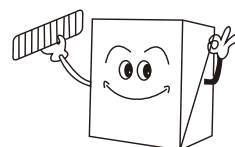

HOW TO USE

BEFORE USE

- Remove shipping package, tape, etc, and leave doors open ventilate for a while.
- The unit is cleaned before shipment. However, clean the compartment interior after delivery.
- Please insert power supply plug into the wall outlet single-phase to cat voltage.
- Allow the unit to operate for about 1 hour to cool the compartment before placing items in the cooler.



WAIT 5 MINUTES OR MORE BEFORE RE-STARTING

- Restarting the unit immediately after it has been turned off may cause fuses to blow and activate the circuit-breaker, the compressor may be overloaded, and/or other damage may occur.



TEMPERATURE ADJUSTMENT





The electronic controller has been factory set to cool the beverages to lowest temperature approximately 1-5 Centigrade. Should you wish to alter the temperature set point, please adopt the following procedure.

- **Setting the set point (desired temperature)**
 1. Press SET for 1s, the set value will start flashing after a few moments;
 2. Use \blacktriangle  or \blacktriangledown  increase or decrease the value using UP or DOWN;
 3. Press SET to confirm the new value.
- **Switching the device ON/OFF**

Press \blacktriangle  for more than 3s. The control and defrost algorithms are now disabled and the instrument displays the message OFF alternating with the temperature read by set probe.
- **Manual defrost**

Press \blacktriangledown  for DOWN more than 3s.
(the defrost starts only the temperature conditions are valid).
- **Access and setting**
 1. Press SET for 3s (the display will show "PS");
 2. To access the parameter menu, press SET;
 3. Scroll inside the parameter menu using \blacktriangle  / \blacktriangledown  ;

To display/set the values of the parameter displayed, press SET, then \blacktriangle  / \blacktriangledown  and finally SET to confirm the changes (returning to the parameter menu). To save all the new values and exit the parameter menu, press SET for 3s; To exit the menu without saving the changed values (exit by timeout) do not press any button for at least 60s.

HOW TO USE

DRAIN TRAY

- Defrosting is performed automatically and drain water is collected in the drain tray.
- Water in the drain tray is evaporated automatically. In humidity, there is a large amount of water in the drain tray, so please throw away drain water once a day.

EFFICIENT USE

- To prevent cold air from escaping, open and close the door quickly and keep the door opened for as short a time as possible.
- Please install the unit in the place which is well-ventilated.

SHELF HEIGHT ADJUSTMENT

The shelf height can be adjusted.

Arrange the shelves in accordance with the dimensions of the items to be placed in the cooler.

PLACING ITEMS IN THE SHOWCASE

This showcase employs a forced circulation of cold air system. If circulation of cold air is obstructed, the items will not be adequately refrigerated. Pay attention to the following points:

- Do not let items obstruct the cold air inlet and suction outlet.
- Place items so that they do not protrude from the shelves. The gap between the shelves and the door is used for circulation of cold air.
- Place items evenly on all shelves.

Please do not display goods on the bottom. Please put goods on the shelf.

Commercial refrigeration display cooler.

INSTRUCTION MANUAL

CLEANING



WARNING

To prevent any electrical shock hazards or injury by rotating circulation fan, always disconnect the power cord plug from the wall outlet before cleaning.

1 EXTERIOR AND COOLER COMPARTMENT

Wipe with a soft, dry cloth. If very soiled, wipe with a cloth that has been moistened with a detergent. Then wipe with a cloth that has been dipped in water.



WARNING

WARNING: Do not splash water directly onto the cooler and do not wash with water. Short-circuit and electrical shock could result.

- Clean the cooler regularly to keep it clean at all times.
- Never use polishing powder, soap powder, benzene, oil or hot water as these will damage the painting and plastic components.

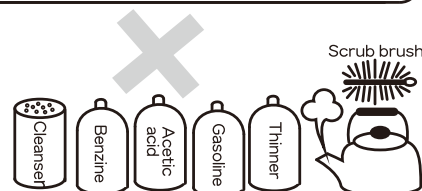

2 CHECKS

To ensure the safety, perform the following checks after cleaning.

- Is the power cord plug firmly inserted into a dedicated wall outlet? Confirm that the plug is not abnormally hot.
- Check the power cord for cracks and damage. Should the slightest irregularity be observed, contact the dealer from whom you purchased this unit or our customer's service.

IN CASE OF THE FOLLOWING

1 POWER FAILURE

Keep opening and closing of the door to a minimum.
Avoid placing new items in the cooler as this will raise the temperature inside the compartment.

2 WHEN NOT USED FOR A LONG PERIOD

Remove all items from the compartment and disconnect the power cord plug from the wall outlet.
Clean the compartment interior and wipe away all water.
To prevent mold formation and bad smell, leave the door open to dry the compartment completely.

3 TRANSPORTATION

Disconnect the power cord plug from the wall outlet.
When moving the cooler, make sure that the feet do not damage the power cord.
Do not let the feet hit against floor steps, thresholds, etc.

4 TEMPORARY STORAGE

Affix a piece of wood, etc. Between the door and main unit to prevent complete closing of the door.
Make sure not to store the unused cooler at a location where children play.
Should a child enter the compartment and the door is closed, the child may not be able to open the door from the inside.

INSTRUCTION MANUAL

BEFORE REQUESTING SERVICE

Please check the following items if you encounter problems with the unit. If the problem continues after taking the proper remedial actions, disconnect the power cord plug from the wall outlet. Transfer the items stored in the cooler to a box or other container. Then contact the dealer from whom you purchased this unit and be ready to provide information as listed in "REQUIRED INFORMATION" below.



CAUTION

To prevent any electrical shock hazards, do not disconnect the power cord plug from the wall outlet with wet hands.

BEFORE REQUESTING SERVICE

<p>No refrigeration at all</p>	<ul style="list-style-type: none"> ● Is the power supply interrupted? ● Is the power cord plug disconnected from the wall outlet? ● Are the shop's power fuses blown and/or the circuit breaker activated?
<p>Inadequate refrigeration</p>	<ul style="list-style-type: none"> ● Is the temperature setting appropriate? ● Are items obstructing the cold air inlet and suction outlet? ● Are stored items packed too tight? ● Is the door open or is it opened and closed frequently? ● Is the condenser clogged?
<p>Excessive noise</p>	<ul style="list-style-type: none"> ● Are all feet in firm contact with the floor? ● Is the rear panel of the cooler contacting the wall or other objects? ● Are other objects in contact with the cooler?
<p>Condensation on cooler exterior</p>	<ul style="list-style-type: none"> ● Condensation may condense on the exterior and door during hot and humid days or depending on the place of installation. This occurs when the humidity is high and water particles in the air contact cold surfaces. This is normal. wipe away condensation with a dry cloth.

Showcase sometimes stop running when thermostat turns off.

INSTRUCTION MANUAL

REQUIRED INFORMATION

- | | |
|--|---|
| <p>① Nature of malfunction
(as accurately as possible)</p> | <p>④ Customer's name, address,
phone number</p> |
| <p>② Product number</p> | <p>⑤ Year and date of purchase</p> |
| <p>③ Serial number</p> | <p>⑥ Desired date for service visit</p> |
- } ON RATING LABEL
ON CARTON

WARRANTY

WARRANTY INFORMATION

Please speak to your Retailer before calling **BTO AMERICA LIMITED** (also known as **KingsBottle**) if you did not purchase your Beverage Cooler directly from **BTO AMERICA LIMITED**

- **limited warranty:** If your refrigerator is not operating, KingsBottle reserves the right to repair or replace the refrigerator. KingsBottle may request the consumer to contact a local refrigeration company to service the refrigerator. All cost for labor and materials is covered for 1 year from the date of receipt. If KingsBottle deems the unit not repairable, KingsBottle will use the value of your original order toward a replacement. For customer service, please contact **BTO AMERICA LIMITED** by e-mail (service@kingsbottle.com).
- **The limited warranty does not cover:** Damage due to such things as accident, misuse, abuse, mishandling, neglect, unauthorized repair or any other cause beyond the control of the seller whether similar or dissimilar to the foregoing. Purchaser understands and acknowledges that the goods sold here are Beverage Coolers, which house wine. Purchaser assumes all the risk of using these units, including risk of spoilage, humidity variations, temperature variations, leaks, fires, water damage, mold, mildew, dryness and similar perils that may occur.
- **SPECIAL NOTE:** Warranty is only honored for the unit which is purchased and used in United States of America. And, if your product was purchased at any 3rd party retailer and not directly from KingsBottle, we do not offer an extended warranty policy. You **MUST** contact the retailer of purchase directly. In the event your retailer does not offer an extended warranty plan, we recommend you contact a third party warranty provider. However, regardless of point of purchase, all KingsBottle coolers are backed by a ONE YEAR manufacturer's warranty from date of sale.



COMPRESSOR BEVERAGE COOLER



www.kingsbottle.com