

KINGS  BOTTLE

KINGS  BOTTLE

USER MANUAL

Pharmacy Refrigerator

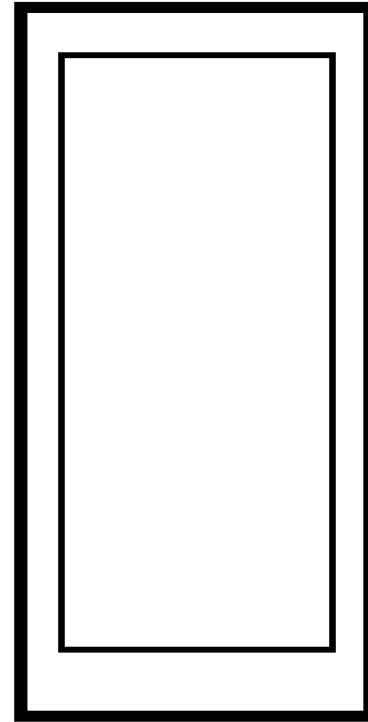

[MODEL]

KBU5L316
KBU5L416
KBU5L756
KBU5L1006



Warning:

Before using this product, please read this manual carefully and keep it for future reference. The design and specifications are subject to change without prior notice for product improvement. Consult with your dealer or manufacturer for details.

Contents

Safety warnings	1
Product features	3
Precautions and safety measures	4
Precautions for use.....	9
Product installation	10
Product composition and overview.....	15
Operating instructions.....	16
Key functions	17
Alarms	25
Maintenance and care	28
Troubleshooting and maintenance services	30
Specifications	31
Packing list	32
Electrical schematic diagram.....	33
Warranty Information.....	34

Safety Warning



Warning: Flammable refrigerant is adopted for the product.

- ❗ **WARNING:** Keep all ventilation openings in the enclosure or, in the structure for building-in, clear of obstruction.
- ❗ **WARNING:** Do not use mechanical devices or other means to accelerate the defrosting process, other than those recommended by the manufacturer.
- ❗ **WARNING:** Do not damage the refrigerant circuit.
- ❗ **WARNING:** In order to reduce flammability HAZARDS the installation of this equipment shall only be carried out by a suitably qualified person.
- ❗ **DANGER – Risk Of Fire Or Explosion. Flammable Refrigerant Used. To Be Repaired Only By Trained Service Personnel. Do Not Puncture Refrigerant Tubing.**
- ❗ **CAUTION – Risk Of Fire Or Explosion. Flammable Refrigerant Used. Consult Repair Manual / Owner's Guide Before Attempting To Install Or Service This Equipment. All Safety Precautions Must be Followed.**
- ❗ **CAUTION – Risk Of Fire Or Explosion. Dispose Of Properly In Accordance With Federal Or Local Regulations. Flammable Refrigerant Used.**

This unit is intended for use in commercial, industrial, or institutional occupancies as defined in the Safety Standard for Refrigeration Systems, ANSI/ASHRAE 15.

Replacement components and servicing

The installation and operating instructions shall indicate that component parts shall be replaced with like components and that servicing shall be done by the manufacturer's authorised personnel, so as to minimize the RISK of possible ignition due to incorrect parts or improper service.

AVERTISSEMENT: S'assurer que toutes les ouvertures de ventilation ne soient pas obstruées.

AVERTISSEMENT: Ne pas utiliser de dispositifs mécaniques ou d'autres moyens pour accélérer le processus de dégivrage, autres que ceux recommandés par le fabricant.

AVERTISSEMENT: Ne pas endommager le circuit FRIGORIFIQUE.

AVERTISSEMENT: Afin de réduire les DANGERS d'incendie, l'installation de cet appareil doit être effectuée uniquement par une personne dûment qualifiée.

RISQUE d'incendie ou d'explosion. Utilisation de FLUIDE FRIGORIGENE INFLAMMABLE. Ne pas utiliser de dispositifs mécaniques pour dégivrer les APPAREILS DE REFRIGERATION. Ne pas percer les tubes FRIGORIFIQUES.

ATTENTION – RISQUE d'incendie ou d'explosion. Utilisation de FLUIDE FRIGORIGENE INFLAMMABLE. Consulter le manuel de réparation/guide d'entretien avant de tenter d'installer ou d'entretenir cet appareil. Toutes les précautions de sécurité doivent être suivies.

ATTENTION – RISQUE d'incendie ou d'explosion. Éliminer de façon adaptée selon les règlements fédéraux ou locaux. Utilisation de FLUIDE FRIGORIGENE INFLAMMABLE.

Cet appareil est destiné à une utilisation commerciale, industrielle ou institutionnelle, comme défini dans la norme de sécurité des systèmes frigorifiques, ANSI/ASHRAE 15.

Les instructions concernant l'installation et le fonctionnement doivent indiquer que les composants doivent être remplacés par des composants similaires et que l'entretien doit être effectué par le personnel autorisé par le fabricant, afin de réduire le plus possible le RISQUE d'inflammation possible dû à des parties ou à un entretien inadéquats.

Product features

This product can be used to store medicines, vaccines, reagents and materials that need to be stored at 2~8°C.

Product function

Accurate temperature control & traceable data

- Microcomputer temperature control displays accuracy of 0.1°C
- Temperature can be set between 2°C to 8°C, and in the box, it fluctuates $\leq 2^{\circ}\text{C}$, adjustable and accurate.
- With USB interface, the temperature data can be traced and stored at any time

Efficient refrigeration & energy saving mute

- Kings bottle is a world-renowned compressor brand that focuses on energy saving, environmental protection, high efficiency and noise suppression.
- High efficiency condenser fan of famous brand and evaporator fan with vortex effect refrigeration are adopted, with stable and lasting performance and low noise
- Ensure that the temperature in the box is more uniform and stable, and the cooling speed is more efficient
- Unique technologies of embedded air duct and air curtain of the industry are adopted

Multiple alarms & safe and stable

- With perfect sound and light alarms, it can realize high and low temperature alarms, power failure alarm, sensor failure alarm and other functions. Alarm temperature value is set based on demand.
- The design of safety door lock ensures the safety of samples in the box.

User-friendly design

- Multi layer encryption shelf design and adjustable height can maximize the use of space
- The inner LED lights, bright and energy-saving, make the stuff in the box clear at a glance
- 97 ~ 127V wide voltage design ensures stable operation of the device.

Precautions and safety measures

Dear users of Kings bottle:

Hi! Thank you for using Kings bottle pharmacy refrigerator.

For your convenience to understand this manual, use the product, and prevent personal injuries and goods damages, please read the following instructions thoroughly.



Failure in complying matters highlighted in warning signs may cause serious casualties.

 Actions or operations that must be prohibited



Failure in complying matters highlighted in warning signs may cause serious casualties, or damages to the pharmacy refrigerator and related property losses.

 Behavior or operation that must be observed



Product with the symbol that reads "prevent fire, stay away from fire sources".



 Please use a power socket with a ground wire to prevent electric shock.

If the power socket is not grounded, the grounding wire must be installed by professional technicians.

 Be sure to place the pharmacy refrigerator firmly on a solid and flat ground. If the ground is not stable or the place is not suitable, the pharmacy refrigerator might be overturned or people will be injured.

- ❗ If the power cord needs to be lengthened, the sectional area of the lengthened cord shall not be less than 2.5mm². At the same time, the length is not longer than 3 m. Otherwise, it may cause a fire or electric shock.
- ❗ In case of flammable gas leakage, it is necessary to close the gas leakage valve and open doors/windows, for ventilation. Do not open any electrical switch, and do not plug in or pull out the power plug of the pharmacy refrigerator, otherwise it may cause explosions and fires.
- ❗ Only professional technicians or after-sales maintenance personnel can disassemble the pharmacy refrigerator, otherwise it may cause fires or electric shock.
- ❗ Please use the special power supply indicated on the nameplate of the pharmacy refrigerator, otherwise it may cause fire or electric shock.
- ❗ If the voltage is lower than 97 V or higher than 127 V, it is necessary to install more than 4000 W automatic voltage regulator suitable for motor load.
- ❗ The power cord of this pharmacy refrigerator is equipped with a three-wire (grounded) plug, which meets the standard three-wire (grounded) socket of 10 A.
- ❗ Under no circumstances should the grounding pin of the power cord be removed. Make sure that the power plug and socket are plugged firmly and reliably, otherwise it may lead to fires.
- ❗ When unplugging from the power socket, hold the power plug firmly and remove it. Do not pull the wires of the power plug directly. If you pull the wire by hand, it may cause electric shock or fires due to short circuit.

- ❗ If the pharmacy refrigerator is not working properly, please unplug the power plug. It may cause electric shock or fires if it continues to operate under abnormal conditions.
- ❗ Before any repair or maintenance of the pharmacy refrigerator, always disconnect the power supply of the pharmacy refrigerator to prevent electric shock or personal injuries.
- ❗ Make sure that the medicine or suspended particles inside and around the pharmacy refrigerator will not be inhaled during maintenance, otherwise it may be harmful to health.
- ❗ When storing toxic, harmful, or radioactive materials, please use a pharmacy refrigerator in a safe area. Improper use may cause harm to human health or the environment.
- ❗ When the pharmacy refrigerator is not used for a long time, unplug the power plug to prevent electric shock, leakage or fires caused by the aging power cord.
- ❗ If the pharmacy refrigerator is idle for a long time in an unsupervised area, make sure that the child does not approach the pharmacy refrigerator and that the disposal of the pharmacy refrigerator is to be carried out by the appropriate personnel. The door should be removed to prevent accidents such as suffocation.
- ❗ No flammable, explosive, dangerous or volatile stuff should be stored in pharmacy refrigerator. Do not use combustible sprays near the pharmacy refrigerator, otherwise it may cause explosions or fires.
- ⊘ Do not store corrosive stuff such as acids and alkalis in the pharmacy refrigerator. Otherwise, the internal components or electrical parts of the pharmacy refrigerator may be damaged.
- ⊘ Packaging plastic bags should not be placed where children can reach them, because plastic bags may cause suffocation.

- ⊘ Do not climb on the pharmacy refrigerator or put the stuff on the pharmacy refrigerator, otherwise will fall over and cause personal injuries or damages to the pharmacy refrigerator.
- ⊘ Don't use the pharmacy refrigerator in the open air. When the pharmacy refrigerator is wet by rain, it may cause electric leakage or electric shock.
- ⊘ Pharmacy refrigerator should not be placed in damp places or places vulnerable to splashing water. Otherwise, electric leakage or electric shock will be caused due to insulation reduction.
- ⊘ Do not pour water directly on the pharmacy refrigerator, otherwise it may cause electric shock or short circuit.
- ⊘ Users are not allowed to disassemble, repair or modify the pharmacy refrigerator by themselves. Otherwise, it may cause fires or personal injuries due to improper operations.
- ⊘ Do not ground the pharmacy refrigerator through gas pipe, power supply pipe, telephone line or lightning rod. The above grounding may cause electric shock or other hazards.
- ⊘ Do not touch any electrical parts such as power plug or any switch with wet hands, otherwise electric shock may be caused.
- ⊘ Do not put containers or heavy objects containing water on the pharmacy refrigerator. If the object falls, it may cause personal injuries, and the outflow of water will reduce the insulation and cause leakage or electric shock.
- ⊘ Do not insert metal objects such as nails or wires into any openings and gaps of the pharmacy refrigerator or into any vent used for internal air circulation, otherwise electric shock or injury may be caused by the above objects contacting with moving parts.



Note

- ! There should be no obstruction around the pharmacy refrigerator and the ventilation should be smooth. It is necessary to check the pharmacy refrigerator setting when restarting the pharmacy refrigerator after power failure or power off.
- ! Changes in settings may damage stored items.
- ! Once the power of the pharmacy refrigerator is cut off, it will take more than five minutes to turn it on again to avoid damages to the compressor or system.
- ! Gloves should be worn during maintenance to avoid touching the sharp edges or corners and injuries to personnel.
- ! Hold the handle to close the door so that the door will not catch your fingers.
- ! When moving pharmacy refrigerators, the inclination angle should not be more than 45 degrees.
- ⊘ When transporting the pharmacy refrigerator, be careful not to trip over pharmacy refrigerator to prevent damages to pharmacy refrigerator or personal injuries.
- ⊘ Please do not use the door handle to lift or carry the device, in case of damages to the pharmacy refrigerator or personal injuries.
- ⊘ The refrigeration circuit must not be damaged.
- ⊘ Do not use electrical appliances in the storage room of pharmacy refrigerators except for those recommended by the manufacturer.

Precautions for use

- ★ Before putting stuff into the device, please make sure that the temperature in the storage room has reached the set temperature, and then put the stuff into the pharmacy refrigerator in batches. The volume of the articles in the box should not exceed 1/4 of its volume at a time to prevent the temperature from rising too much.
- ★ The temperature display value of the device is to show the temperature at the temperature sensor in the storage room. There is a certain difference between the displayed temperature and the actual temperature at the center of the device when the device just starts. As the device enters a stable state, the displayed temperature will gradually reach the actual temperature.
- ★ The device box body is provided with a detection hole so as to lead out the test line in the box during the test. After the test line is led out, it is necessary to plug the test hole with insulating material again, otherwise the temperature in the box may not reach the set temperature value, and condensation will appear around the outside of the through hole.
- ★ Please use diluted neutral cleaner to clean the device. Do not use brushes, acid, gasoline, soap powder, polishing agent or hot water to clean the device, otherwise the painted surface and plastic rubber parts may be damaged. Attention: Do not use volatile solvents such as gasoline to clean plastic and rubber parts.
- ★ When the device is not in use for a long time, cut off the power supply and turn off the battery.
- ★ Each time you access the items, please try to reduce the time to open the door to avoid large fluctuations in temperature and humidity inside the box.
- ★ After the door is opened, the temperature inside the box will rise sharply in a short time. This is normal, and the situation will be restored within 1 hour after the door is closed.
- ★ Under high temperature and high humidity environment, glass door may condense, which is normal phenomenon and does not affect the storage temperature in the box. If condensation occurs, please change door heating mode to mode 4 (default setting is mode 2). Please improve ventilation conditions as soon as possible to lower the ambient temperature.

Product installation

Product handling -----

1. Protect the pharmacy refrigerator in moving it, same as shown as below photo, please move it by handcart with cushion.
2. Remove all packing materials and bottom cushion, then move into house for placement.
3. After moving it to appropriate location, wait for 2 hours before power on.

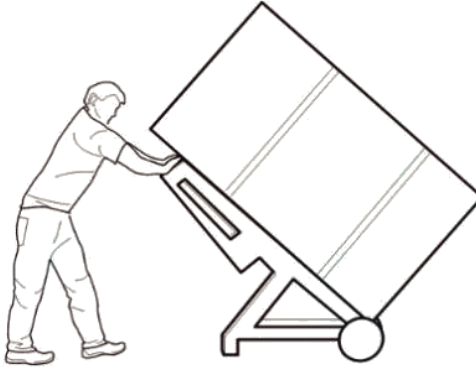

Installation environment -----

- ★ The pharmacy refrigerator is only for indoor use, with second pollution level and second type of over-voltage
- ★ ambient temperature is within 16°C-32°C, and recommended temperature is within 18°C-25°C. If necessary, air conditioning system should be used.
- ★ Environmental humidity: lower than 80%Rh.
- ★ Avoid heavy dust.
- ★ Avoid mechanical sway or vibration.
- ★ The altitude of working position of refrigerator is lower than 2000m .
- ★ Input voltage: between 97v~127v
- ★ Ingress protection: IPX0.
- ★ The pharmacy refrigerator is sensitive to ambient temperature. When installed in other environments than the one aforesaid, the pharmacy refrigerator can't operate normally. Please improve the environment before use.
- ★ It is prohibited to install the pharmacy refrigerator in an open environment. When the pharmacy refrigerator is wet by rain, it may cause electric leakage or electric shock.

Installation site-----

- ★ Do not install the device in a narrow and confined space and install it in a place that can ensure its normal access, to avoid damage to storage goods by maintenance difficulties and delayed repair in case of device failure.
- ★ The installation floor must be solid, flat, non-combustible and able to bear the weight of the device during operation.
- ★ Provide good ventilation and avoid direct sunlight.
- ★ Each device needs a separate power outlet, please ensure that the power outlet should withstand a current of ≥ 10 A. The plug and socket are firmly connected.
- ★ Check the working voltage before use. In areas with unstable voltage, a voltage stabilizer suitable for device load should be considered for voltage stabilization, and the power of the voltage stabilizer should be greater than 4000 W to ensure that the input voltage requirements in the installation environment can be met.
- ★ Device shall be reliably grounded. If the power cord socket is equipped with grounding wire, check whether the grounding is good before use. If the socket is not grounded, it must be installed by professional engineers and technicians.



Warning

- ★ Do not ground the refrigerator through gas pipe, water supply pipe, telephone line or lightning rod, which may cause electric shock.
- ★ After installation, the power plug must be accessible, so that the power cord can be unplugged in time in case of emergency. Nothing should cover the vent of the refrigerator.



Note

- ★ As the ambient temperature has a great impact on the device, if the above environmental requirements cannot be met, the device may not be able to operate normally. Please improve the environment before using the device; the device is an intermittent operation working system.
- ★ Ambient storage and transportation temperature: $-40^{\circ}\text{C}\sim+60^{\circ}\text{C}$, relative humidity: 10%~90%.

Preparation before use -----

1. Remove the outer packaging of all products (including the protective foam in the packing box).
2. Check the accessories; please check the contents in the box according to the packing list. If there is any discrepancy, please contact the after-sales service in time.
3. Placement conditions: a gap of at least 10 cm should be left around the pharmacy refrigerator to facilitate ventilation and heat dissipation.

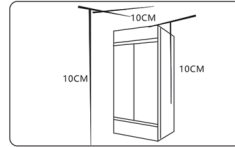

4. Lock the front casters, and adjust the adjustable feet (optional)
Please rotate the adjustable feet clockwise to extend it downward and make it firmly stand on floor, to ensure the pharmacy refrigerator stands steady in daily use.

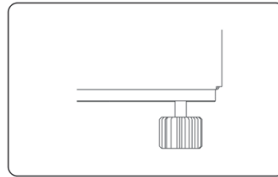
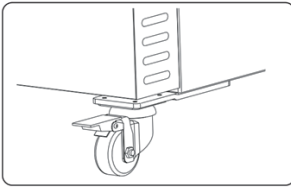

5. Adjust the layers space to install shelves according to the actual needs.

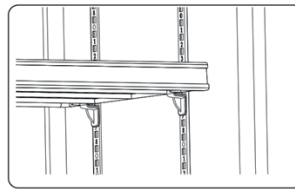
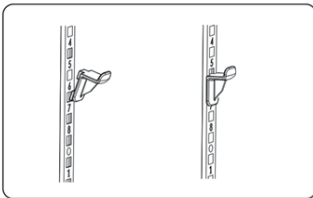

6. Install door handle (optional).

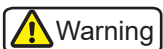
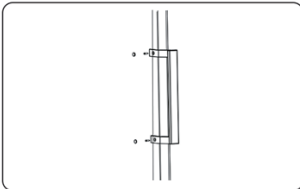

★ Don't put the plastic bags in the place where children come into contact, so as to prevent suffocation accidents.

Initial start-up -----

Please observe the following rules when conducting initial start-up:

1. Under no-load condition, please connect the power plug to right plugboard, and the plugboard should not be shared with other appliances.
2. After turning on the power supply, turn on the battery switch of the device, check if the inner LED light works properly.
3. Set recorder time, data recording interval time, etc according to actual need, please refer to the operation instructions below for details.
4. Set parameter of cabinet temperature, high(low) temperature alarm deviation, etc according to actual need. Default setting temperature is 5°C, high temperature alarm is 8°C and the low temperature alarm is 2°C, please refer to the operation instructions below for details.
5. "H1" alarm occurs at the initial operation stage, indicates the temperature in cabinet is high. The alarm will stop when the temperature in cabinet drops to the set temperature.
6. "LoF" alarm occurs at the initial operation stage, indicates the data recorder is not started. Please start the data recorder refer to the operation instructions below.
7. "BL" alarm occurs at the initial operation stage, indicates the low battery power alarm, and alarm will be automatically relieved after 2-6 hours of power on.
8. Observe equipment operation for more than 3 hours, ensure equipment runs stably, store items in cabinet in batches.

Operation after power failure -----

The device has the memory function for the set value. When the power is restored after the power failure, the device will continue the operation before the power failure.



Warning

- ★ Once the power of the refrigerator is cut off, it will take more than five minutes to turn it on again to avoid damages to the compressor or system.
- ★ When the refrigerator is not used for a long time, unplug the power plug and turn off the battery switch (applicable to battery items) to prevent electric shock, leakage or fire caused by aging of the power cord.
- ★ If the refrigerator is left idle for a long time in an unsupervised area, please ensure that children do not approach the refrigerator and the door cannot be completely closed.



- A special person shall be responsible for the operation of this product, and check and record it every day. If the temperature in the cabinet is too high or too low, the goods shall be transferred to other pharmacy refrigerator, and the goods shall not be stored again until the fault is eliminated.
- This product is a pharmacy refrigerator, and the temperature in the pharmacy refrigerator ranges from 2°C to 8°C. Please make sure that the stored items are consistent with the environment in the pharmacy refrigerator, so as to avoid damage to the items and economic losses.
- Due to the refrigeration inertia, the display temperature and humidity of this product are different from the actual temperature and humidity in the box, which is a normal phenomenon.
- Please don't place items in the space between the bottom of the inner tank of the pharmacy refrigerator and the bottom shelf, so as not to block the air duct.



- All pharmacy refrigerators are for preservation. Hence, it is strictly forbidden to put too many relatively hot items at one time, which will cause the compressor not to stop for a long time, the temperature drops slowly and affects the service life of the compressor. Stuff must be put in batches, and the temperature should be lowered step by step until it falls to the required temperature!
- The refrigeration circuit shall not be damaged.
- Unlicensed electrical appliances are not allowed to use inside the pharmacy refrigerator.

Product composition and overview



Schematic diagram (eg:KBU5L316 , KBU5L416)

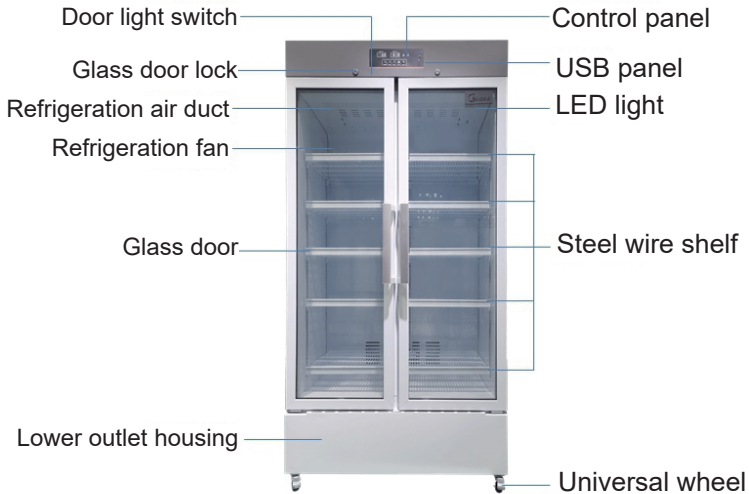

Schematic diagram (eg: KBU5L756 , KBU5L1006)

Due to the improvement of products and different models, the actual products may be different from the schematic drawings. Please refer to the real objects! The sketch is only used for the description of the functional parts.

Operating instructions

Operation and display panel

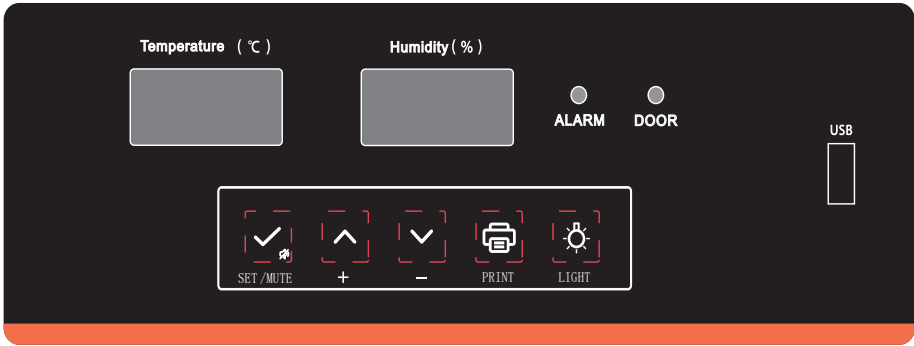

Digital tube display instructions

The right digital tube only displays humidity and keeps humidity display unchanged, while the left digital tube displays temperature, alarm codes, menu, parameters and other information.

The “digital tube” mentioned in “key operation” below refers to the left digital tube.



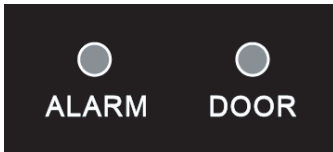

Indicators



Indicator status	Alarms
Alarm light off	Temperature in the box is normal.
Alarm light on	Temperature in the box is abnormal.
Door light off	The door is closed.
Door light on	The door is open.

Key functions

Key names

Key symbols	Key names
	Set/Mute key
	Up key
	Down key
	Print key
	Light switch

Key operation

Key lock function

- a) When the key is unlocked, the key will be locked if there is no key operation for 60s or Up key and Down key are pressed for 3s at the same time.
- b) When the key is locked, only ambient temperature can be checked and Mute key and Light switch key can be operated, and other keys are locked.
- c) Key unlocks operation steps:
 1. Under locked conditions, press both Up key and Down key for 3 seconds, and display shows "000".
 2. Set Up key and Down key to change password(initial password is 005).
 3. Press Set/Mute key to confirm unlocked, and return to normal display, key lock light closed.

User parameter setting

For details about the parameters that can be adjusted by users, refer to the user menu parameter table. Parameter setting steps as below:

1. Under key unlocked conditions, press Set/Mute key 3 seconds, display shows"PS1".
2. Press Up key, Down key to choose the parameter needs to be changed.
3. Press Set/Mute key to parameter changing interface.
4. Press Up key, Down key to change parameter.
5. No key operation for 60 seconds or press Set/Mute key 3 seconds to save parameter and quit.

Temperature setting example(set temperature from 5 to 3)

Steps	Operation	Display shows
1	Press key to unlock(refer to previous instruction)	
2	Press Set/Mute key 3s	PS1
3	Press Up key,Down key to choose settable parameter"SET"	SET
4	Press Set/Mute key	005
5	Press Up key, Down key to change parameter to 3	003
6	Press Set/Mute key 3s to save parameter and quit	

Door electrical heating mode setting example(set door electrical heating mode from 2 to 4)

Steps	Operation	Display shows
1	Press key to unlock(refer to previous instruction)	
2	Press Set/Mute key 3s	PS1
3	Press Up key, Down key to choose settable parameter"P1"	P1
4	Press Set/Mute key	002
5	Press Up key, Down key to change parameter to 4	004
6	Press Set/Mute key 3s to save parameter and quit	

Key unlocked password setting example(set password from 5 to 7)

Steps	Operation	Display shows
1	Press key to unlock(refer to previous instruction)	
2	Press Set/Mute key 3s	PS1
3	Press Up key, Down key to choose settable parameter"PS1"	PS1
4	Press Set/Mute key	005
5	Press Up key, Down key to change parameter to 7	007
6	Press Set/Mute key 3s to save parameter and quit	

Start the recorder

When the key is unlocked, when the recorder is not started, the digital tube gives flashing alarm and displays "LoF". Then press the Set / Mute key and Up key for 3s at the same time, and the digital tube stops displaying "LoF".

Recorder time setting instruction

Every time when the pharmacy refrigerator reconnected to power after a power failure, display automatically shows 1、 2、 3、 4、 5、 6、 7、 8、 9、 n in turn, users can set parameters as in below table while n is displayed.

n	Year
y	Month
r	Date
s	Hour
F	Minute
Pt	Printing interval
SCY	Data recording interval

"Year"setting example(set year to 2022)

Steps	Operation	Display shows
1	Display shows n	n
2	Press Set/Mute key	0
3	Press Up key, Down key to change parameter to targeted year	22
4	Press Set/Mute key	
5	Press Set/Mute key 3s to save parameter and quit	

"Month" setting example (other r,s,F,Pt,SCY setting refers to this example)

Steps	Operation	Display shows
1	Display shows n	n
2	Press up key, down key to choose settable parameter "y"	y
3	Press set/mute key	0
4	Press up key, down key to change parameter to targeted month	
5	Press set/Mute key 3s to save parameter and quit	

Please finish setting in 2 minutes. If no operation, it will automatically quit in 2 minutes and shows normal.

Please export previous data record before changing recorder time and data recording interval time, otherwise the data may be lost.

Manually generate PDF files

When the key is unlocked and no file is being generated, connect the USB flash disk and press the Up key for 3s until the digital tube displays "d01". Press the Up or Down key to adjust "d00~d12". Press the Set / Mute key, and the USB flash disk inside cancels the file generation (d00) or generates the PDF files of the previous months (1~12) in which the data is recorded.

Light switch

When the working voltage is normal, press the Light switch key to turn on or off the light.

Mute the alarm

- a) When the alarm beeps, press the Set / Mute key to cancel the alarm. When the alarm mute indicator is on, it will enter the state of checking the ambient temperature.
- b) When the alarm is canceled, press the Set / Mute key to restore the alarm. When the alarm mute indicator is off, it will enter the state of checking the ambient temperature.
- c) In the key unlocked state, when checking the state of ambient temperature, press the Set / Mute key to cancel or restore the alarm. Within 10min after canceling the alarm, the temperature alarm persists. 10min later, the buzzer will beep again.

Check the ambient temperature

- a) When the key is locked, press the Set / Mute key to display the ambient temperature on the digital tube. After no key operation for 5s, or press the Up and Down key to return to normal display.
- b) When the key is unlocked, press the Set / Mute key to display the ambient temperature on the digital tube and return to normal display after no key operation for 5s.

Record the temperature

The recorder stores the data every 10min.

Export the USB data

- (1) After the USB flash disk is connected to the USB interface, the recorder buzzer beeps once, the digital tube displays the upload data code “on” (in case of large amount of data) and the USB flash disk generates the PDF files on data of current month and last month. After the completion of data transmission, the buzzer beeps once and the digital tube displays “End”. After 6s, the digital tube returns to normal display. Note: In case of less data, the digital tube does not display “on” and “end” prompts.
- (2) When the USB flash disk is always connected to the recorder module, the data will be imported into the USB flash disk every other month and the PDF file on the data of current month is generated. When the buzzer beeps once, the digital tube displays the upload data code “on” (in case of large amount of data). After the completion of data transmission, the buzzer beeps once and the digital tube displays “End”. After 3s, the digital tube returns to normal display.
- (3) When the USB flash disk is connected to the recorder module and the file is not generated, the PDF files of the current month and the previous 12 months can be generated manually.

Data printing (optional)

- (1) For automatic printing, when the printing interval (Pt) is not 0, the printer prints the current data every Pt minute. Note: When the printing interval (Pt) is less than the recording interval of 10min, print according to the recording interval; Otherwise, print according to integral multiples of recording interval. That means printing interval (Pt) is less than integral multiples of recording interval.
- (2) For manual printing, press the key to print the data of the current day and the previous 7 days and the printing interval is the same as the automatic printing interval.

Manual printing setting steps

Under unlocked and normal operation voltage conditions, display shows “P01” after pressing printing key, press up key and down key to set “P00~P07”, press set/mute key or printing key, remove the manual printing(P00) or print last days(1~7days) recording data.

Note: the functional configuration of the product varies. Please refer to the actual configuration.

Printer (optional)

Outer appearance

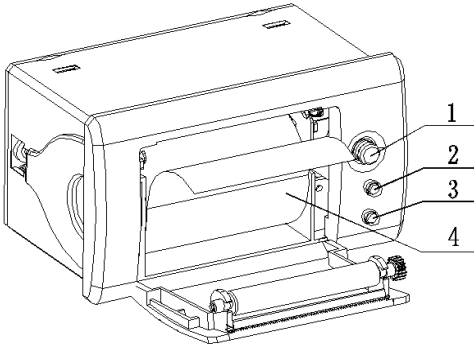

1. Open Button
2. Self Button, Error
3. Lf Button, Power indicator
4. Paper roll

Outer dimension

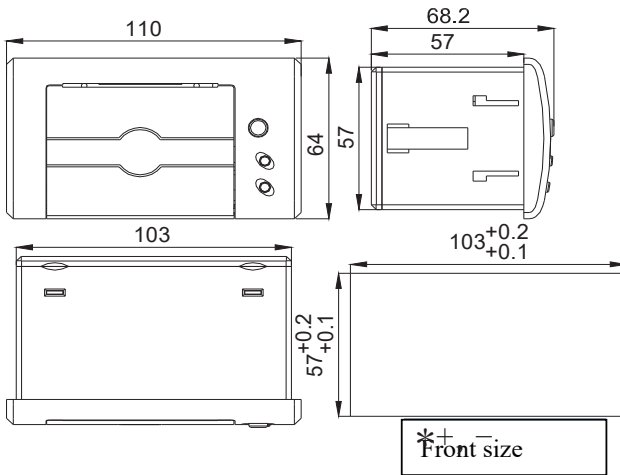

Paper install

Press the button to open the door. After loading the paper roll, close the door.

Light and button operation

SEL

Online status switching button. Under online status, the interface printing is valid. Under offline status, **【LF】** button is valid. The default is online status when printer is power on.

LF

When printer is power on, this button is online status. At this time, pressing **【SEL】** button to be offline status and press LF button to feed paper. Press again to stop paper feeding. During online status, this button is valid.

Power indicator (green)

Indicates on/off status of power.

Errors and busy status alarm light (red)

Light status	Instruction
off	Normal working
Blink once, off 1second	Lack of paper, waiting for has returned to normal after the paper.
Blink twice, off 1second	The nose too warm, waiting for the nose temperature is reduced.
Flashing 3 times, off 1second	The nose heating plate damage, irreversible, need to repair.

Mark When the printer is in a state of busy, red light will light up.

Self-test and HEX

Self-test can test whether the printer is working properly or not. If the self-test receipt can be printed correctly, it means the printer is normal except the interface with the host. Otherwise, the printer will need to be repaired.

Self-test receipt and analysis

In self-test receipt, software version, interface forms, characters and other configuration information are printed. Self-test receipt shown in the figure below:

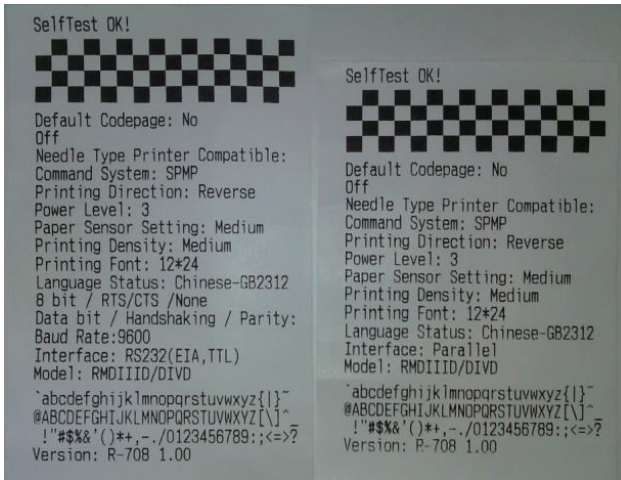

self-test receipt

In the figure, the left one is self-test receipt for serial interface model and the right one is for parallel interface model. The printing sequence is from the below to above.

Mark:

1、 Due to that the default configuration item may be different when the printer is out of factory, the font size of self-test receipt and the content of each configuration is according to the actual content of printed receipt. The above picture is just for reference.

2、 The specific content of each item set can reference " printer parameters setting" section. After setting manually each time, it can be test whether the setting is successfully through printing self-test receipt.

Self-test method:

- 1、 Hold down the "SEL" button and turn on the printer, then loosen the button, the printer will print out the self-test list.
- 2、 Under normal working mode, click SEL button once, then hold down the LF button, at the same time, click the SEL button, the printer will print self-testlist.

Hex printing method

Hold the [LF] button and connect the power. At this time, the red indicator light will flash once one second. After three flashes of indicator, loosen **【LF】** button. The red indicator will continue to flash. After flashing three times again, the flashing stops. The printer will print out "Hexadecimal Dump". Now the printer enters into the hex printing mode.

Alarms

Serial number	Alarm code	Alarms	Alarm reason
1	H1	Alarm for high temperature in the cabinet	Interior temperature >SEt+H
2	L1	Alarm for low temperature in the cabinet	Interior temperature <SEt-L
3	H2	High ambient temperature alarm	Ambient temperature >tH1
4	do	Door open alarm	Door ajar time over 1 minute
5	PF	Low voltage alarm	Low battery voltage
6	EP	High voltage alarm	High battery voltage
7	BL	Low battery alarm	Low battery
8	Eb	Abnormal battery alarm	Battery abnormal
9	E1	Alarm for control sensor failure	Sensor error
10	E2	Alarm for upper temperature sensor failure	Display sensor error
11	E4	Alarm for ambient temperature sensor failure	Ambient temperature sensor error
12	E5	Alarm for evaporator temperature sensor failure	Defrostation sensor error
13	E7	Alarm for humidity sensor failure	Humidity sensor error
14	EE	Alarm for communication failure of display panel	Display communication failure
15	Er	Alarm for communication failure of recorder	Recorder communication failure

Note: If the alarm cannot be restored, please contact after-sales service.

Note: The functional configuration of the product varies. Please refer to the actual configuration.

User menu parameter list

Menu level	Menu	Menu description	Setting range	Default	Unit
User menu	MAX (optional)	Maximum temperature in the current time period	---	---	°C
	MIN (optional)	Minimum temperature in the current time period	---	---	°C
	CLR (optional)	Clear the record of the maximum and minimum temperature in the current time period.	0: clear 1: not clear	0	/
	SEt	setting	0.0~10.0	5.0	°C
	H	Upper deviation on high temperature alarm	0.0~10.0 0: cancel the alarm	3.0	°C
	L	Lower deviation on low temperature alarm	0.0~10.0 0: cancel the alarm	3.0	°C
	n	Check the current date - year	--	--	/
	y	Check the current date - month	--	--	/
	r	Check the current date - day	--	--	/
	S	Check the current date - hour	--	--	/
	F	Check the current date - minute	--	--	/
	Pt (optional)	Printing interval	0~240	20	min
	tH1	Ambient temperature alarm value	20.0~50.0	40.0	°C
	P1	Door heating mode selection	1: automatic heating mode 1 2: automatic heating mode 2 3: automatic heating mode 3 4: the door keeps open 5: the door keeps closed	1	/
	P2 (optional)	Display mode selection	1: average temperature 2: upper temperature 3: lower temperature	1	/
PS1	Password setting of user menu	000~999	005	/	

Glass door electrical heating mode instruction:

Select 1 for glass door electrical heating mode P1: heating for 3 minutes after door opened and closed. If door opened and closed again during heating procedure, heating time will restart.

Select 2 for glass door electrical heating mode P1: electrical heating turns on while compressor operating; electrical heating turns off in 1 minutes delay after compressor shutdown.

Select 3 for glass door electrical heating mode P1: electrical heating turns on while interior humidity is over 80%, electrical heating turns off while interior humidity is under 60%; electrical heating is always on while humidity sensor error or shield.

Select 4 for glass door electrical heating mode P1: electrical heating keeps turning on.

Select 5 for glass door electrical heating mode P1: electrical heating keeps turning off.

Maintenance and care

Warning

- ★ To prevent electric shock or personal injuries, please make sure that power is disconnected before having any repairs or maintenance on the device.
- ★ When maintaining the device, make sure that you do not inhale surrounding medications or suspended particles that could damage your health.

Note

- ★ Do not directly sprinkle water on the box, so as to avoid the decline of insulation performance of electrical components and rust of metal parts.
- ★ Do not use hot water, corrosive detergent or organic solvent to clean the cabinet.
- ★ Do not put heavy objects on the top of the device to avoid deformation of the device under pressure.

Device maintenance

Defrosting: The device will automatically defrost during the working process, which is convenient to use.

Cleaning and maintenance:

- 💧 The device shall be cleaned once a month. Regular cleanings can keep the pharmacy refrigerator fresh.
- 💧 Use a dry cloth to wipe off a small amount of dust outside and inside of the pharmacy refrigerator as well as that on all accessories. If the pharmacy refrigerator is dirty, use a cleaning cloth soaked with neutral detergent to remove the dirt, wipe off the residual detergent with a wet cloth, and then wipe it again with a dry cloth.
- 💧 Do not dump water on the shell of the pharmacy refrigerator or inside the pharmacy refrigerator, otherwise the insulation of electrical appliances may be damaged and faults may occur.
- 💧 The compressor and other mechanical parts are completely sealed without lubrication.

Device deactivation

Deactivation: If the device is stored in an unsupervised area for a long time and is not used, the power supply should be cut off and the inner and outer surfaces of the box should be wiped clean with a warm and wet soft cloth, and then dried and sealed; It is necessary to ensure that the device is locked, and that children cannot open the door to prevent accidents such as suffocation.

End-of-life period: When the device reaches the end of its service life, it should be scrapped and must be handed over to qualified professional recycling organizations for scrapping and disposal in accordance with local regulations and ordinances; non-professionals should not disassemble or decompose the device without authorization; Scrapped device should be placed in designated areas that are inaccessible to children to avoid danger.

Troubleshooting and maintenance services

When there is a failure in the product, please check and handle it according to the following table. If the situation cannot be changed, please inform Aegis Biological Service Center in time. We will serve you wholeheartedly to avoid any loss to you.

Malfunction	Troubleshooting
Refrigerator does not work	Check whether the input power meets the requirements
	Whether the plug and the socket are in poor contacts
	Whether the input and control lines are faulty
	Whether the voltage is too low
The cooling effect is not obvious, and the temperature exceeds the standards	Whether too many or overheated items are stored
	Whether there is a certain gap between the stored items
	Whether there is direct sunlight or other heat source radiation
	Whether the door is open frequently
	Whether the ambient temperature is too high
Excessive noise	Whether the air duct is blocked
	Whether the refrigerator is placed stably
	Whether a part of the cabinet contacts with external objects or walls
The alarm lamp flashes and the buzzer gives an alarm.	During use, it is normal for the actual noise to differ from the marked value due to the influence of loaded items, ambient noise, unclosed doors, compressor opening and closing, etc.
	Whether the objects are just put in and the temperature is not stable at 3~7°C. After operating for some time, the alarm disappears.
	Whether the door alarm is caused by not fully closing the door. Close the door again
	Whether the battery is low. It will return to normal after running for some time
	Whether the temperature exceeds the standard

Specifications

Name	Pharmacy Refrigerator	Pharmacy Refrigerator	Pharmacy Refrigerator	Pharmacy Refrigerator
Model number	KBU5L316	KBU5L416	KBU5L756	KBU5L1006
External Dimensions(wxdxh)(mm)	595*603*1920	690*653*1920	970*808*1920	1220*808*1920
Internal Dimensions(wxdxh)(mm)	500*464*1343	595*514*1343	880*634*1354	1130*634*1354
Fridge Storage Volume	316L	416L	756L	1006L
Door	Transparent glass door/ Framelass glass door	Transparent glass door/ Framelass glass door	Transparent glass door/ Framelass glass door	Transparent glass door/ Framelass glass door
Foaming Agent	Cyclopentane	Cyclopentane	Cyclopentane	Cyclopentane
Shelf	5 plastic-dipping steel wire shelves	5 plastic-dipping steel wire shelves	10 plastic-dipping steel wire shelves	10 plastic-dipping steel wire shelves
Cooling Type	Forced air cooling	Forced air cooling	Forced air cooling	Forced air cooling
External Material/Inner Material	Spraying steel plate/HIPS plate	Spraying steel plate/HIPS plate	Spraying steel plate/PCM plate	Spraying steel plate/PCM plate
Condenser/Evaporator	Micro-channel/Fin	Micro-channel/Fin	Micro-channel/Fin	Micro-channel/Fin
Controller	Microprocessor	Microprocessor	Microprocessor	Microprocessor
Refrigerant, Amount(g)	R600a,36g	R600a,36g	R600a,48g	R600a,48g
Light	LED light	LED light	LED light	LED light
Net weight	72kg	88kg	140kg	160kg
Rated Supply Voltage	115V~/60Hz	115V~/60Hz	115V~/60Hz	115V~/60Hz
Rated Power/Current	190W/2.5A	260W/3.0A	320W/3.6A	380W/4.0A
Protection Against Electric Shock	I	I	I	I
Power connection mode	Y	Y	Y	Y
USB Port	Yes	Yes	Yes	Yes
Pollution Degree	(2)	(2)	(2)	(2)
Over voltage category	II	II	II	II
Battery	12V1.3A/20HR	12V1.3A/20HR	12V1.3A/20HR	12V1.3A/20HR

Packing list

Model number	Instruction	Key	Accessory bag	Steel wire shelf with installation buckles	Price list	Door handle
KBU5L316	1	2	1	5	5	0
KBU5L416	1	2	1	5	5	1
KBU5L756	1	2	1	10	10	2
KBU5L1006	1	2	1	10	10	2

*The warranty card and certificate are included in the instruction and the specific packing list shall prevail in accordance with the real product.

Electrical schematic diagram

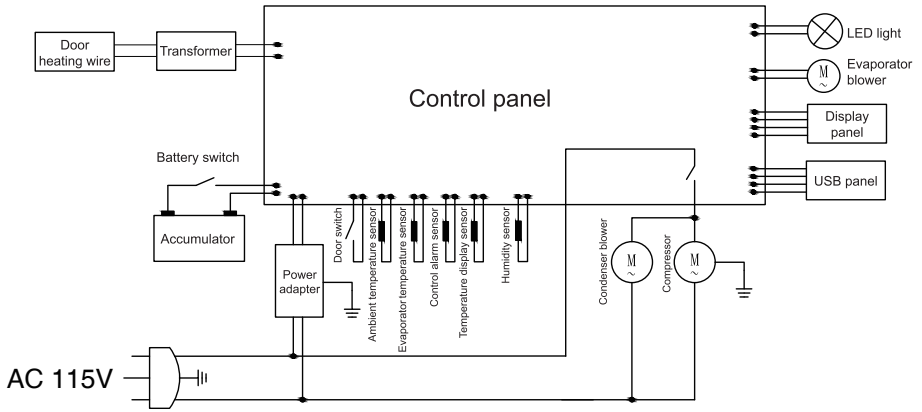

Electrical schematic diagram of KBU5L316 , KBU5L416

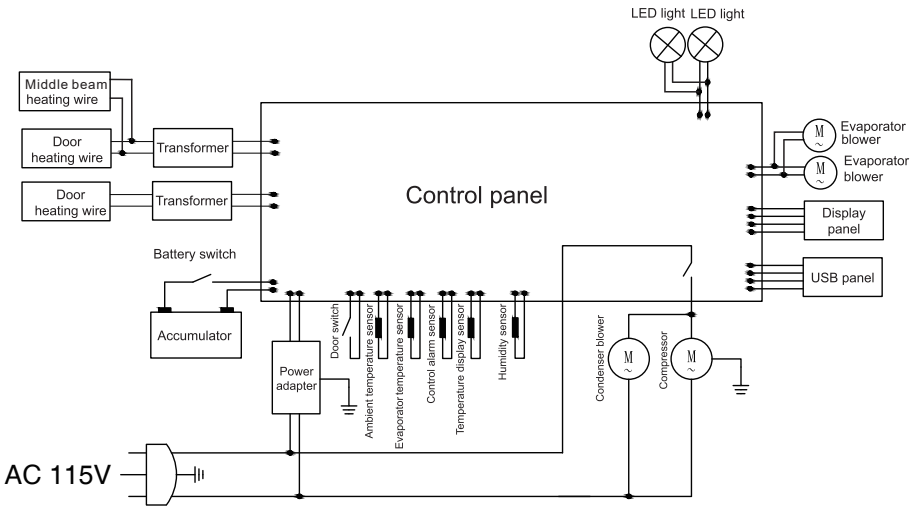

Electrical schematic diagram of KBU5L756 , KBU5L1006

Warranty Information

Please speak to your retailer before calling us if you did not purchase your refrigerator directly from KingsBottle.

WHO IS COVERED: This warranty is extended only to the original end-user purchaser or the person receiving the product as a gift, and shall not be extended to any other person or transferee.

LIMITED WARRANTY – If your refrigerator is not operating properly, KingsBottle reserves the right to repair or replace the refrigerator. KingsBottle may request the consumer to contact a local refrigeration company to service the refrigerator. All cost for labor and materials is covered for 2-year from the date of receipt. If KingsBottle deems the unit not repairable, KingsBottle will use the value of your original order toward a replacement (Any replacement unit will follow the warranty terms of the initial purchase). For customer service, please e-mail us via hello@kingsbottle.com.

THE LIMITED WARRANTY DOES NOT COVER: Damage due to such things as an accident, misuse, abuse, mishandling, neglect, unauthorized repair or any other cause beyond the control of the seller whether similar or dissimilar to the foregoing. Purchaser understands and acknowledges that goods sold here are biomedical freezers, which house drugs, vaccines, and reagents, they are applicable to hospitals, epidemic prevention stations, universities, scientific research institutes and electronic chemical industry enterprise labs. Purchaser assumes all the risk of using these units, including the risk of spoilage, humidity variations, temperature variations, leaks, fires, water damage, mold, mildew, dryness and similar perils that may occur.

SPECIAL NOTE: Warranty is only honored for the unit which is used in the countries where the unit was initially purchased. And, if your product was purchased at any 3rd party retailer and not directly from KingsBottle, we do not offer an extended warranty policy. You **MUST** contact the retailer of purchase directly. In the event your retailer does not offer an extended warranty plan, we recommend you contact a third party warranty provider. However, regardless of point of purchase, all KingsBottle coolers are backed by a TWO YEAR manufacturer's warranty from date of sale.