



WINE & BEVERAGE **COMBO**

KINGSBOTTLE 2017

QUIET

EMBRACO compressor, a leading edge compressor produced by a company known for its quality and reliability. The result is a quiet cooler with quality, stability, durability and energy efficiency.

ENERGY SAVING

The Italian brand **CAREL** controller, renowned for its reliable performance, exceptional temperature control, and precision cooling, defrosting and energy management.

OPTIMIZED STORAGE

The interior cabinet and wood shelves are re-designed and optimized for maximum bottle capacity with standard Bordeaux, Pinot Noir, Riesling, and Champagne/ Sparkling Wine bottles in mind.

WINE & BEVERAGE COOLERS COMBO



KBU-50COMBO-BW2



KBU-100COMBO-BW2



KBU-170COMBO-BW2

Traditionally, there have been wine connoisseurs and beer connoisseurs, which means two different storage temperatures. KingsBottle is proud to break this tedious tradition with our innovative dual temperature wine and beverage coolers. Now you can enjoy an icy cold beer or a gently chilled bottle of wine all from the same unit! All of our combo units are perfect for bars, restaurants or that perfect home entertainment room - they have a little something for everyone. These units are so popular we have trouble keeping them in stock! We know that whether your favorite beverage is a well-aged glass of wine, a hoppy micro brewed IPA, or your favorite soda pop, the serving temperature can take your drink from "good" to sublime and we believe that every drinking experience should go above and beyond your expectations. KingsBottle can bring even more flavor to your drink. Cheers !

Key Features:

- Long life, high quality, quiet running compressor that provides vibration free cooling.
- Italian brand CAREL high quality temperature controller, with automatic defrosting control mode, room high/low temperature alarm system, energy-saving management.
- State of the art fan - fan circulated air-cooling system. Cool air blows and distributes throughout the cabinet to ensure temperature uniformity in the entire cooler.
- Unique front-venting heat dispersion systems that allow each cooler to be built-in to cabinetry with minimal clearance.
- Beautiful hard wood shelves are strong, even under heavy loads, and warp resistant. Optimized for maximum bottle capacity and designed with standard Bordeaux, Pinot Noir, Riesling, and Champagne/Sparkling Wine bottles in mind. (* Wine Cooler)
- Steel ball-bearing rollers to ensure effortless placement and extraction of bottles regardless of weight. (* Wine Cooler)
- Gas charged tempered safety glass door, UV double layered coated glass to protect wine from both incandescent and fluorescent light sources.
- Lock with a spare key to protect your stock.

What's new in 2017 ?



With the move to Embraco compressors, we have partnered with an innovator in the compressor industry. At the heart of our units is a leading edge compressor, produced by a company known for its quality and reliability. The result is a quiet cooler with quality, stability, durability and energy efficiency. Coupled with our industry respected fans create a cooler worthy of the KingsBottle name.



Each unit of COMBO is equipped with a premium, Italian brand Carel controller. Renowned for its reliable performance, exceptional temperature control, and precision cooling, defrosting and energy management.



The interior cabinet and wood shelves are re-designed and optimized for maximum bottle capacity with standard Bordeaux, Pinot Noir, Riesling, and Champagne/Sparkling Wine bottles in mind. (* Wine Cooler)

As a testament to our confidence and quality, our manufacturer's warranty coverage is being extended to 2 years from date of purchase.



KBU-50COMBO-BW2



50 BOTTLE WINE COOLER 160 CANS BEVERAGE COOLER

This brilliant design gives you a dual or triple zone cooling system that will let you store all of your beverage needs in one area, wine, spirits, beer, and fizzy soda drinks. This is the ultimate in home entertainment for that swanky home bar or game room you've been dreaming of. The Kingsbottle Beer and Wine COMBO fridge is unmatched in quality and design. This fridge will be cherished for years to come.

- Set of 2 units, standalone or side by side
- Volume: 5.37 CF for each, total 10.74 CF
- Unit size: 23.42"W x 23.62"D x 33.86"H for each
- Adjustable temperature range: 34-46 for beer, 41-64 F for wine

Note:

The COMBO with the dual zone wine cooler (**KBU-50COMBO-BW3**) is also available



KBU-100COMBO-BW2



100 BOTTLE WINE COOLER 300 CANS BEVERAGE COOLER

This remarkable dual sided unit, two coolers in one, 20 cube feet Beer and Wine Cooler COMBO is made with precision techniques that KingsBottle has been honing for the last decade. Allow all your favorite refreshments the same treatment but in its own cooling unit for beverages. These two sleek premium coolers in one will sit beautifully in your home.

- Set of 2 units, standalone or side by side
- Volume: 10.88 CF for each, total 21.76 CF
- Unit size: 23.54"W x 26.97"D x 55.7"H for each
- Adjustable temperature range: 34-46 for beer, 41-64 F for wine

Note:

The COMBO with the dual zone wine cooler (**KBU-100COMBO-BW3**) is also available



KBU-170COMBO-BW2



170 BOTTLE WINE COOLER 450 CANS BEVERAGE COOLER

KingsBottle appreciates its business consumers as much as its home consumers. We know that a properly stored bottle can mean everything to your customers whether that is a bottle of wine, beer, or even soda. That is why we are proud to introduce the Beer and Wine Cooler Combo. This dual sided unit is two coolers in one, each made with the precision techniques that KingsBottle has been honing for the last decade. Keep your best bottles, regardless of their contents at the perfect serving temperature with this sleek and stylish unit that will not only add value to your beverages, but also to the decor of your home, restaurant or bar.

- Set of 2 units, standalone or side by side
- Volume: 14.3 CF for each, total 28.6 CF
- Unit size: 23.5"W x 27"D x 71.8"H for each
- Adjustable temperature range: 34-46 for beer, 41-64 F for wine

Note:

The COMBO with the dual zone wine cooler (**KBU-170COMBO-BW3**) is also available



SPECIFICATIONS

	Model KBU-50COMBO-BW2	KBU-100COMBO-BW2	KBU-170COMBO-BW2
General Info:			
Volume	10.74 CF (304 Litre)	21.76 CF (616 Litre)	28.60 CF (810 Litre)
Capacity	160 Cans / 46 Wine Bottles	300 Cans / 98 Wine Bottles	450 Cans / 131 Wine Bottles
Installation	Built-in / Front Venting	Built-in / Front Venting	Built-in / Front Venting
Shelf Configuration	4 Chromed Shelves + 6 wooden shelves	5 Chromed Steel Shelves + 10 wooden shelves	8 Chromed Steel Shelves + 13 wooden shelves
Adjustable Temperature Range	Zone-A 34-46°F; Zone-B 41-64°F	Zone-A 34-46°F; Zone-B 41-64°F	Zone-A 34-46°F; Zone-B 41-64°F
At Min/Max Room Temperatures	32-100°F (0 - 38°C)	32-100°F (0 - 38°C)	32-100°F (0 - 38°C)
Noise Level in Decibels	<41dB	<41dB	<40dB
Features:			
Cooling System	Compressor	Compressor	Compressor
Temperature Control	Digital Thermostatic Control	Digital Thermostatic Control	Digital Thermostatic Control
Circulating Fans	Low noise 12 volt	Low noise 12 volt	Low noise 12 volt
Lighting type	Energy friendly LED (Blue)	Energy friendly LED (Blue)	Energy friendly LED (Blue)
Door Type	Glass door with stainless steel frame	Glass door with stainless steel frame	Glass door with stainless steel frame
Electrical:			
Rated Power Input	130 Watts	200 Watts	200 Watts
Refrigerant	R134A	R134A	R134A
Energy Consumption	1.66Kw*h/24h	2.46Kw*h/24h	2.66 Kw*h/24h
Dimensions:			
Unit Size	46.84"W x 23.62"D x 33.86"H (1190W x 600D x 860H mm)	47.08"W x 26.97"D x 55.7"H (1196Wx 685D x 1415H mm)	47.08"W x 27"D x 71.8"H (1196W x 685D x 1825H mm)
Net Weight	224.8 Lbs (102 kgs)	396.8 Lbs (180 kgs)	573.2 Lbs (260 kgs)

BOTTLE CAPACITY



*These bottles are for display only. This product is not available for purchase.

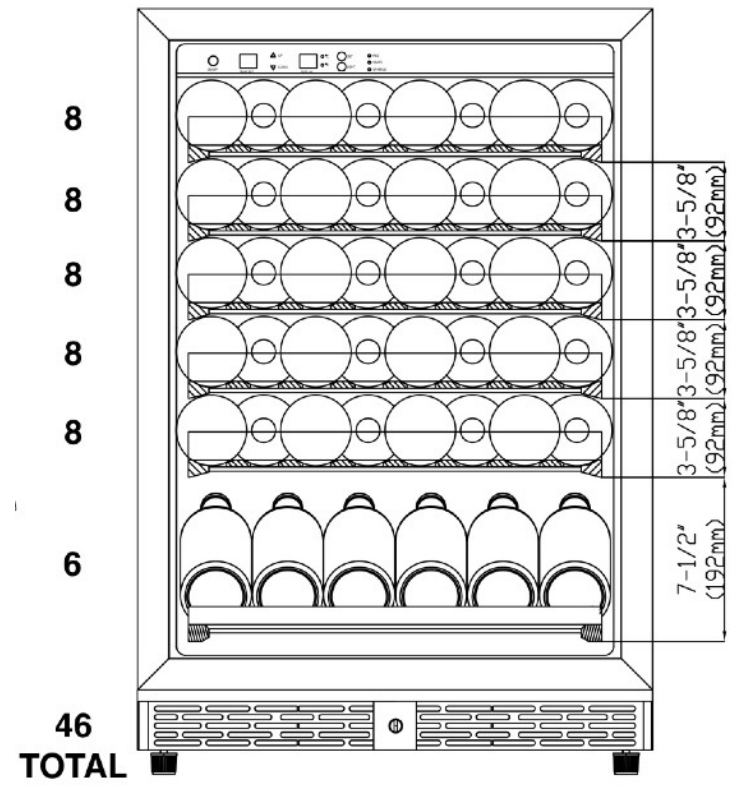
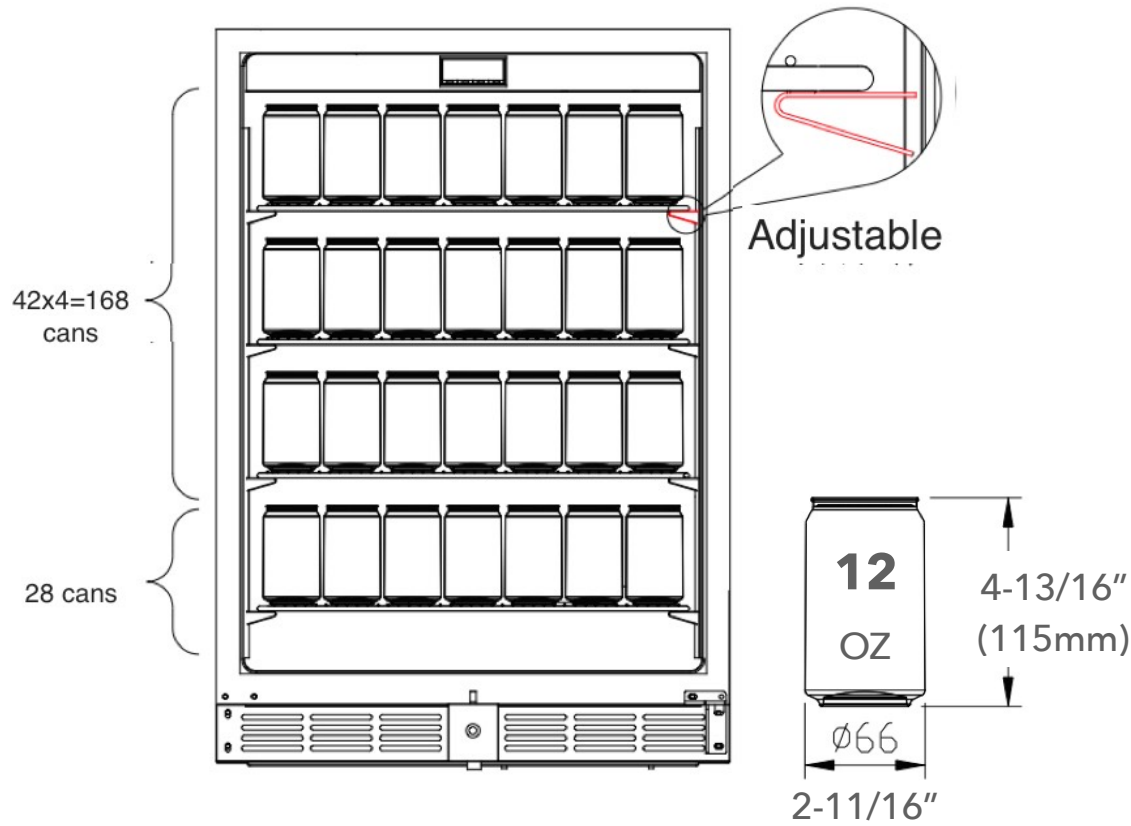

KBU-50COMBO BOTTLE STORAGE

STANDARD SHELVES

Standard Shelves will store perfectly with most bottle diameter of 3.25" (82.5mm) and bottle height of 13.00" (330mm)

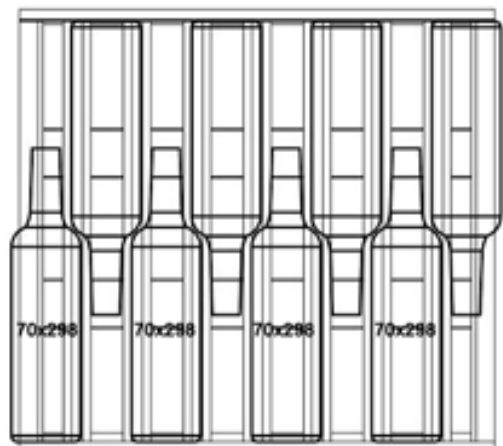

Standard Bordeaux (70mm x 286mm)

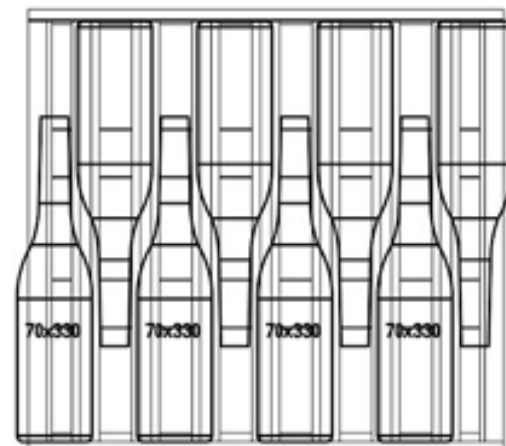

Typical Riesling (70mm x 330mm)

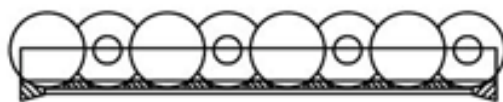

Standard Bordeaux

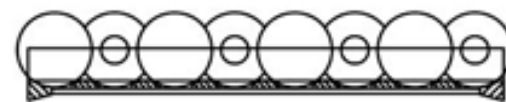

Typical Riesling

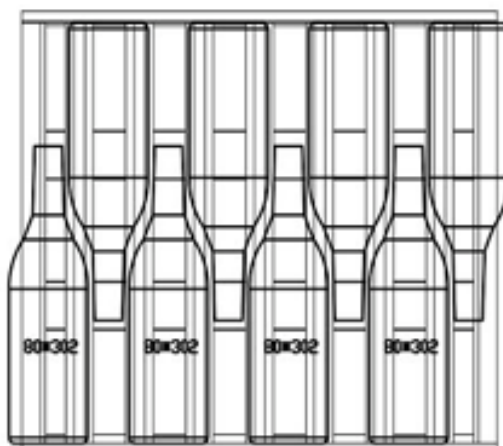

Typical Pinot Noir (80mm x 302mm)

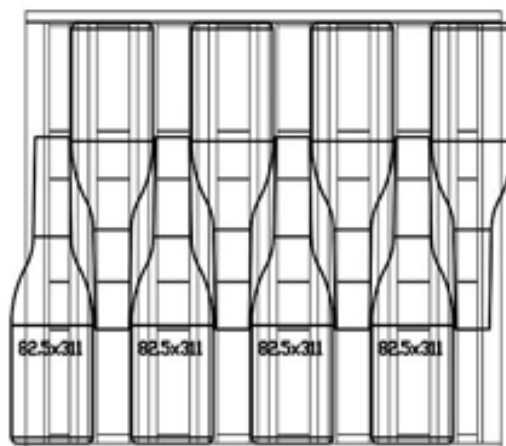

Champagne/Sparkling (82.5mm x 311mm)

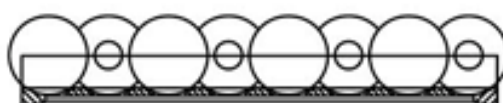

Typical Pinot Noir



Champagne/Sparkling

WINE COOLER | KBU-50W-SS



**6 Wood Wine Shelves
Designed for Maximum
Bottle Compatibility.**

**Fit for Standard
Bordeaux,
Pinot Noir, Riesling and
Champagne / Sparkling**



**Quality Digital Display
Temperature Controller
Italian Brand - CAREL**



**Energy Efficient Blue LED
Lighting System**



**Steel Ball-Bearing Slides
to Maximize Load Bearing
and Ensure Smooth and
Secure Movement.**



**State of The Art
Fan Circulated Air Cooling
System**

**Front Venting System For
Built-in Under Counter**



**Security Door Lock
to Protect Your Stock**



**Gas Charged Tempered
Safety Glass Door with
Stainless Steel Frame
and Handle**



Total 300

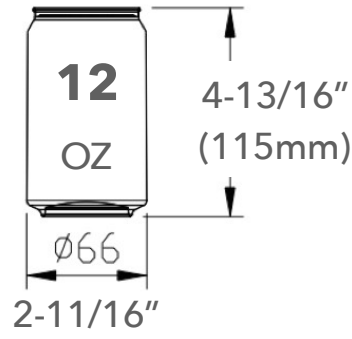
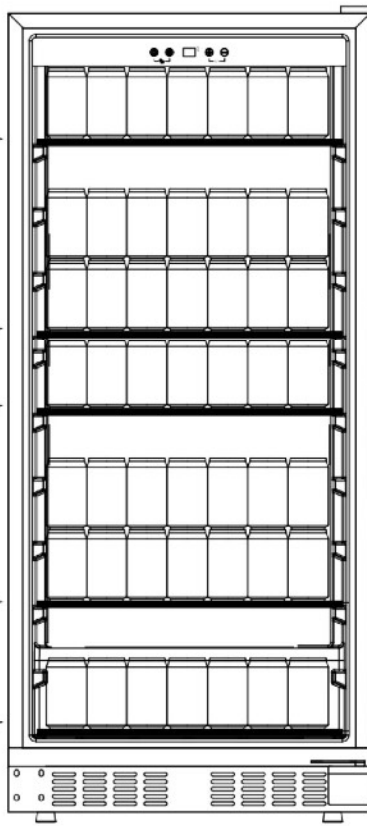

Total 98

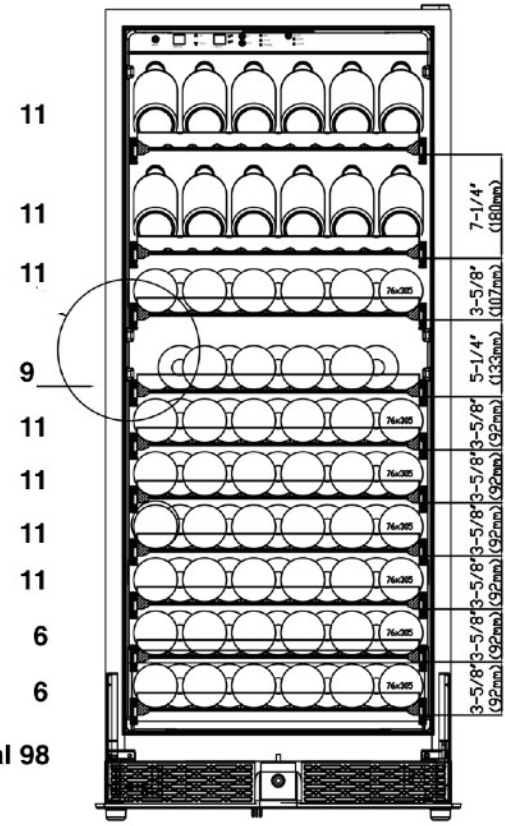

KBU-100COMBO BOTTLE STORAGE

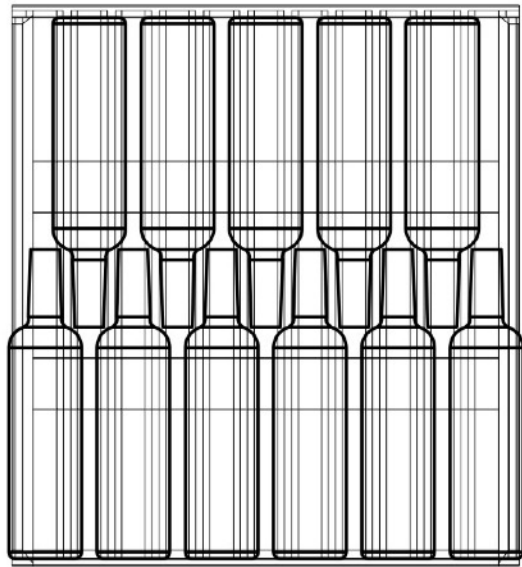

Height: 11.25" (286mm)



Height: 8.50" (216mm)

Diameter: 2.75" (70mm)

Standard Bordeaux
(70mm x 286mm)

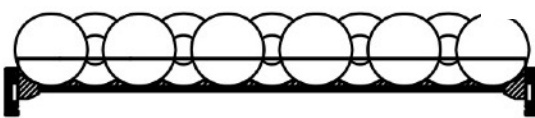

standard Bordeaux

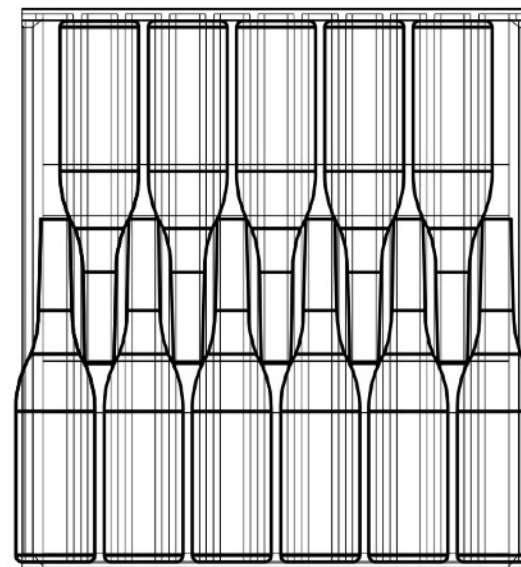

Height: 13.00" (330mm)



Height: 6.50" (165mm)

Diameter: 2.75" (70mm)

Typical Riesling
(70mm x 330mm)

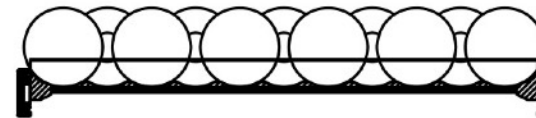

Typical Riesling

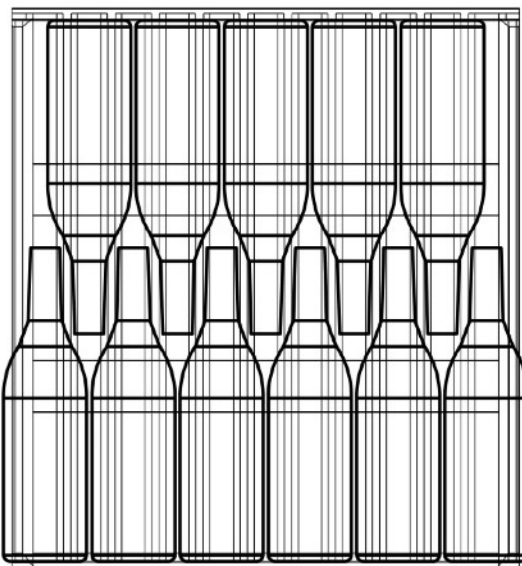

Height: 11.875" (302mm)



Height: 7.50" (190mm)

Diameter: 3.125" (80mm)

Typical Pinot Noir
(80mm x 302mm)



Typical Pinot Noir

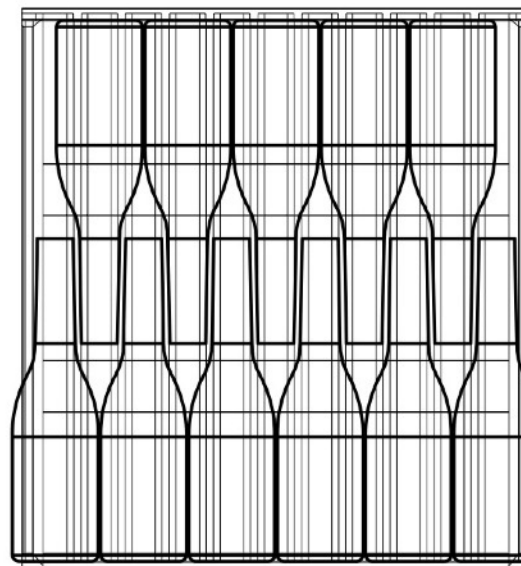

Height: 12.25" (311mm)



Height: 7.00" (178mm)

Diameter: 3.25" (82.5mm)

Champagne/Sparkling
(82.5mm x 311mm)

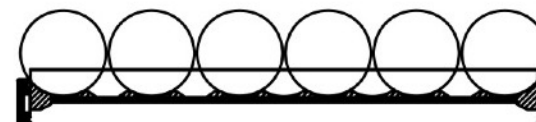

Champagne/Sparkling

WINE COOLER | KBU-100W-SS



2 Display + 8 Standard Wine Shelves Designed for Maximum Bottle Compatibility. Fit for Standard Bordeaux, Pinot Noir, Riesling and Champaign /Sparkling



Quality Digital Display Temperature Controller Italian Brand - CAREL

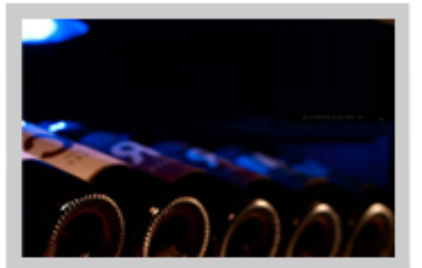

Energy Efficient Blue LED Lighting System



Steel Ball-Bearing Slides to Maximize Load Bearing and Ensure Smooth and Secure Movement.

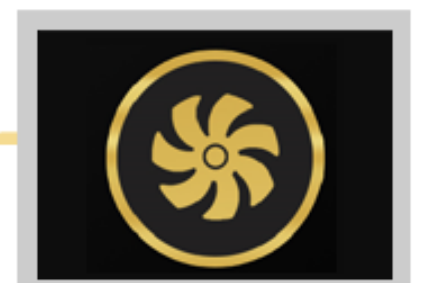

State of the Art Fan Circulated Air Cooling System



Front-Venting System for Built-in Under Counter



Security Door Lock to Protect Yours Stock



Gas charged tempered Safety Glass Door With Stainless Steel Frame and Handle

Total 450

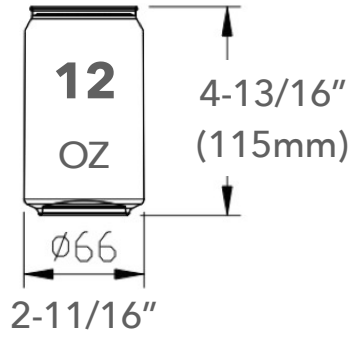
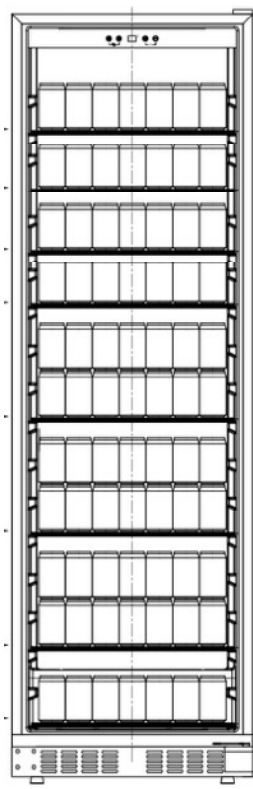

TOTAL 131

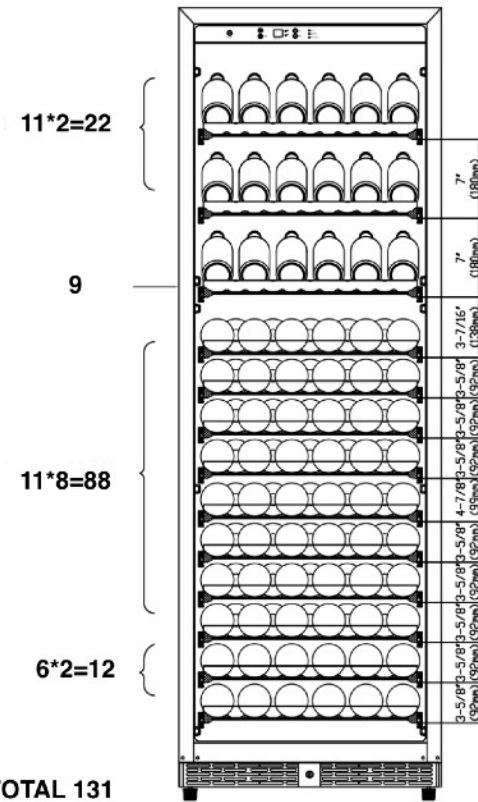

KBU-170COMBO BOTTLE STORAGE

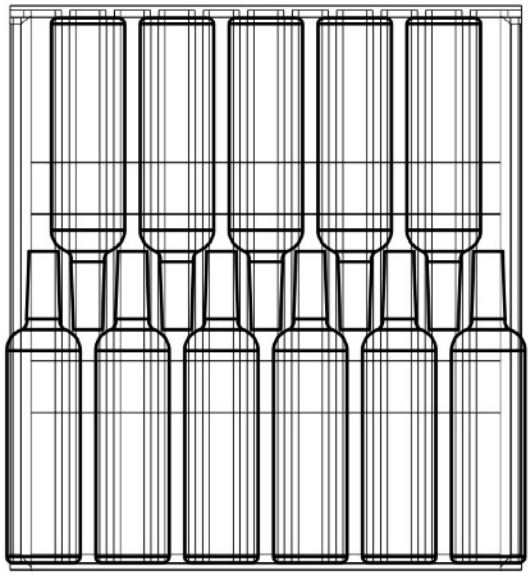

Height:
11.25" (286mm)



Standard Bordeaux
(70mm x 286mm)

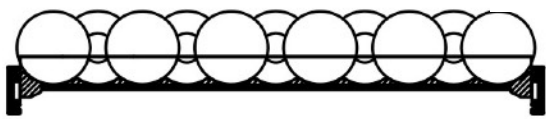

standard Bordeaux

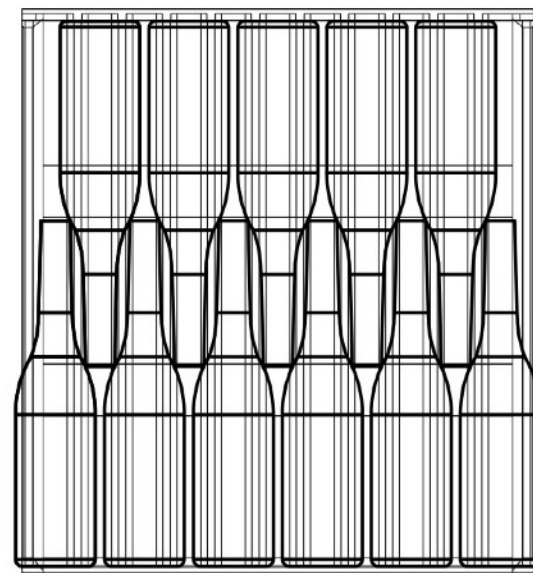

Height:
13.00" (330mm)



Typical Riesling
(70mm x 330mm)

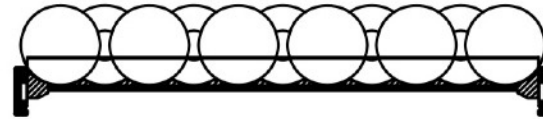

Typical Riesling

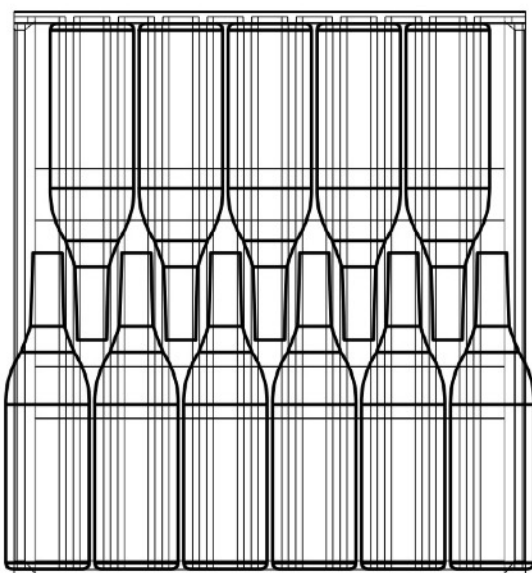

Height:
11.875" (302mm)



Typical Pinot Noir
(80mm x 302mm)

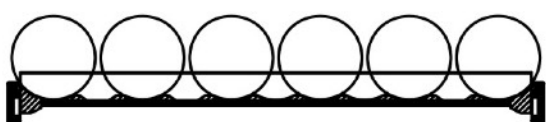

Typical Pinot Noir

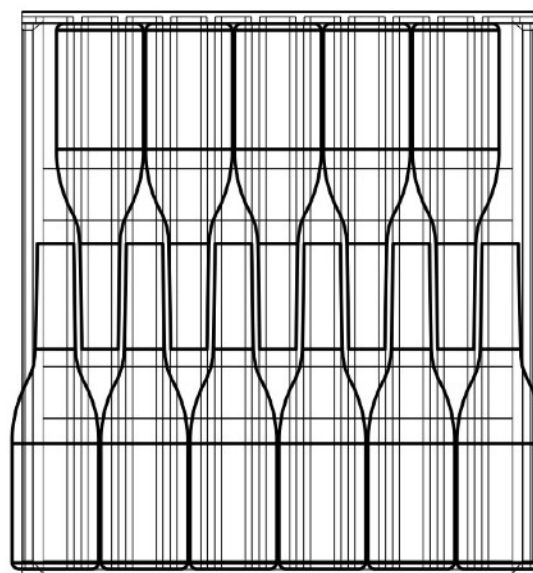

Height:
12.25" (311mm)



Champagne/Sparkling
(82.5mm x 311mm)

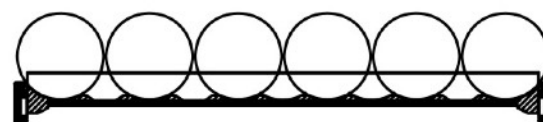

Champagne/Sparkling

WINE COOLER | KBU-170W-SS



3 Display + 10 Standard Wine Shelves
Designed for Maximum Bottle Compatibility.
Fit for Standard Bordeaux, Pinot Noir, Riesling and Champaign /Sparkling



Quality Digital Display Temperature Controller
Italian Brand - CAREL

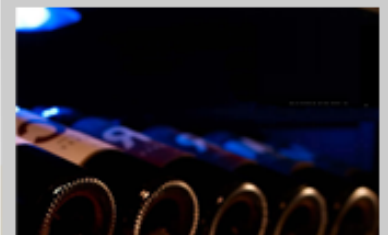

Energy Efficient Blue LED Lighting System



Steel Ball-Bearing Slides to Maximize Load Bearing and Ensure Smooth and Secure Movement.

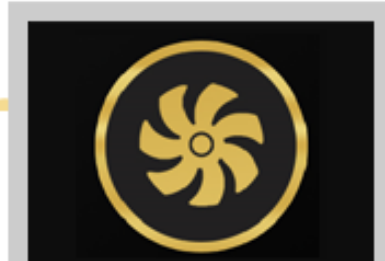

State of the Art Fan Circulated Air Cooling System



Front-Venting System for Built-in Under Counter



Security Door Lock to Protect Yours Stock



Gas charged tempered Safety Glass Door With Stainless Steel Frame and Handle

QUALITY PRODUCTS

HAPPY CUSTOMERS

Beyond expectations

Posted by **Tiffany Schwarz**

We could not be happier with this dual set. The beverage center and dual zone wine fridge is as pleasing to the eye as it is to its contents. It has made the perfect addition to our newly renovated kitchen. This I say with the utmost of praise as I am not one easy to please.

Extremely Satisfied

Posted by **Jason**

We bought the side by side beer cooler and dual zone wine fridge and have had it for about a year now. They function just as advertised. They are extremely quiet and nice to look at. They hold a Ton of beer and wine. They are coolers fit for a King.

Great under cabinet beverage/wine fridge!

Posted by **Sara**

We bought this combo fridge to be installed under our island for beverages and wine. We are very happy with the product! It was easy to set up, holds a lot of wine and other beverages. The dual zone on the wine fridge side is perfect for keeping red and whites in the same place. The products looks great too!

Just as advertised

Posted by **Unknown**

I wanted room for beer and wine. The three temperature zones are great. It has large capacity and looks great. We are really enjoying it!

Worth The Cost

Posted by **Mitchell Edwards**

I wanted a small capacity beer fridge AND a wine fridge to integrate into my bar and this one was exactly what I needed. It has three zones - one for the beer side of the fridge, then the wine side has two different zones so that I can chill my white wine colder than my reds. I didn't really care how it looked as long as it had the functionality I wanted, but the stainless steel door and the black finish are pretty classic and don't stand out too much in the room. It's also really quiet. It was worth the cost to get the features I wanted.

Awesome looking product for bar

Posted by **Unknown**

The product it self is great. The dual zone function on the wine cellar is nice for separating whites and reds. The combined look having them side by side makes our bar area look spectacular.

My only complaint was the shipping time. I paid for the expedited white glove which stated a timeline, but that timeline was not when you receive product, but when they ship it to a 3rd party. Took me an additional 2 weeks to get the products due to delivery schedules.

...