

# OPERATION MANUAL

## COMBINED REFRIGERATOR AND FREEZER

Applicable Models: MLRF289 | MLRF450



Combined Refrigerator and Freezer

**BEFORE USE, PLEASE READ AND FOLLOW  
ALL SAFETY RULES AND OPERATING INSTRUCTIONS**

**BIOMEDICAL COMBINED REFRIGERATOR & FREEZER**



# CONTENTS

## INTRODUCTION

Thank you for choosing KingsBottle for your refrigeration needs. For safe use, please read this manual carefully and follow all instructions. Store this manual near the device for quick referral.

We cannot guarantee safety if this applicant is used for objects other than the intended use or used in any way other than laid out in this manual.

The contents of this manual can change without notice due to improvement of performance or function of the device. Contact our sales representatives if there are any questions about the information contained in this manual. No part of this manual should be reproduced in any form without written permission from KingsBottle.

For important safety notices, please read pages 4-6. Only trained and authorized personnel should operate this biomedical Combined Refrigerator and Freezer. Only qualified service personnel or an authorized agent should install or provide maintenance for this device.

Only use spare parts sold by KingsBottle. If other accessories are used, we cannot be held responsible for any adverse consequences. However, the user can apply for verification of third-party accessories from KingsBottle before use.

You should inspect and maintain the device according to the specified time intervals found in this manual..

Due to differences between each model and improvements of the devices, the actual product may differ from the diagrams included.

Users have an obligation to be responsible for their own safety.

When products are removed from the freezer, always wear protective gloves. Handling contents or touching inside the unit without protective gear can cause frostbite or other injuries.

## TABLE OF CONTENTS

Chapter	Contents	Page
Part I	Precaution For Safe Operation	4-5
Part II	Precaution For Use	6
Part III	Installation Instructions	7-8
Part IV	Diagram & Description of Refrigerator / Freezer	9
Part V	Operating the Refrigerator / Freezer	10-13
PART VI	Maintenance Guide	14
Part VII	After-sale Service Annex1: Rechargeable Battery Maintenance,Installation,Replacement and Disposal Annex2: About installation of printer paper for optional printer. Annex3: Remote alarm terminal and RS485 interface	15-16
Part VIII	Specifications	17
Part IX	Warranty Information	18

**Prop. 65 Warning for California Residents**



**WARNING**

Cancer and Reproductive Harm -  
[www.P65Warnings.ca.gov](http://www.P65Warnings.ca.gov)

# SAFETY

## PART I PRECAUTIONS FOR SAFE OPERATION

Please read this user manual carefully and store near the device for quick referral. The following symbols will be used throughout this manual:



### WARNING

Failure to observe WARNING signs could be hazardous to personnel, possibly resulting in serious injury or death.



### CAUTION

Failure to observe CAUTION signs could result in injury to personnel and damage to the unit or associated property.



### CAUTION HOT

This sign informs the user about the danger of burns from high temperatures.



### DANGER OF EXPLOSION

This sign is a warning of the application of volatile or explosive chemical substances.



### DO NOT TILT



### AVOID DIRECT SUNLIGHT



### WARNING

- Failure to observe the WARNING signs could be hazardous to personnel, causing serious personal injury or even death.
- Because of the presence of carbon dioxide, it is necessary to evaluate the worksite to ensure proper ventilation. If ventilation seems to be restricted, consider other ways to ensure a safe environment: atmospheric monitoring or other warning equipment.
- Do not touch any electrical parts (power supply plug or any switches) with a wet hand. This can cause electric shock.
- Only qualified engineers or service personnel should install this unit. Installation by unqualified personnel may cause adverse events like electric shock or fire.

- Be sure to install the unit on a sturdy floor. If the floor is not sturdy or the installation site has inadequate flooring, the unit may fall or tip over resulting in injury.
- Be careful with the power cord to avoid short circuits or open circuits. When removing the plug from the power outlet, grip the plug and not the cord. Pulling the cord may result in electric shock or fire.
- When installing the unit, do not push the power line up against the wall or other furnishings. Leave room for the compressor and heat source as well.
- Use the dedicated power supply according to the instructions on the rating level provided with the device. If you exceed this value, a performance transformer or appropriate voltage regulator should be installed to ensure safe operation. Otherwise, this may cause damage to the refrigerator / freezer or injury to the user.
- Do not tilt the device or hit the device for any reason. Because of the registration system, unexpected vibration can damage the freezer.
- To avoid overheating, short circuits, or other dangers, install the device in a dry, dust-free environment.
- If the unit makes unexpected sounds, smells, or smoke when turned on, unplug the unit and contact the manufacturer or supplier. Continued operation may cause electric shock or fire.
- Install freezer in a dry and ventilated environment to ensure proper ventilation of the unit. Using the device in a poorly ventilated environment may cause damage by the release of heat.
- Do not disassemble, repair, or modify the unit yourself. Any such work carried out by unauthorized personnel may result in fire or injury due to malfunction of the unit.
- Storing volatile or flammable substances in this unit may cause an explosion or fire. Storing corrosive substances in this unit may lead to damage to the inner components or electrical parts.
- Ensure a safe environment when dealing with poisonous, radioactive, or other harmful substances. Improper use can have a detrimental effect on your health or environment.
- Do not ground the unit near a gas pipe, water main, telephone line, or lightning rod. Such grounding may cause electric shock in the case of an incomplete circuit.
- Use a power supply outlet that is properly grounded to prevent electric shock. If it is not grounded, it will be necessary to install a ground by a qualified engineer.

## PART I PRECAUTIONS FOR SAFE OPERATION



Use a power supply outlet that is properly grounded to prevent electric shock. If it is not grounded, it will be necessary to install a ground by a qualified engineer.

Don't lengthen the line randomly. If you need to use 2.5mm 2 copper line, keep the 4mm 2 lines to connect the electrical outlet.



Be sure to install the unit on a sturdy floor, no shaking or tilting.



Never install the unit in a flammable or volatile location. This may cause explosion or fire.



Never install the unit in a humid place, outdoor or a place with direct sunlight. Deterioration of the insulation may result which could cause current leakage or electric shock.



### CAUTION:

Failure to observe WARNING signs could result in injury to personnel and damage to the unit or associated property.

- The biomedical refrigerator / freezer should only be used as a storage device.
- Always hold the handle while closing the door. This will reduce the likelihood of injury to your hand.
- Restrict access to the key from unauthorized personnel to avoid unexpected injury.
- Locate an even and sturdy floor for installation. This will prevent the unit from tipping or falling. Improper installation may result in injury.
- Regularly check the filter and clean it as necessary. This will avoid possible overheating of the unit.
- When moving the unit, do not tilt it more than 45 degrees. Transportation should be handled with care.

- This biomedical refrigerator / freezer should not be used for inanimate objects, flowers, or other items that are not suitable for low-temperature settings.
- During usage, the temperature inside the unit is very low. Do not touch the interior surface or any objects inside without protective gear.
- Always disconnect the power plug when the unit is not used for long periods.
- When you request any repair or maintenance, have a safety check sheet prepared for the safety of service personnel.
- Check all settings on the controller prior to restarting the freezer.

# SAFETY

## PART II PRECAUTIONS FOR USE

- When the temperature in the refrigerator / freezer has reached the set temperature, put the items in the refrigerator / freezer in batches. No more than 1/3 of the volume of items should be used per batch to avoid the temperature rising too much.
- The temperature display will show the temperature around the sensor initially. There will be a difference between the displayed temperature and the actual temperature in the center of the unit at first. The center temperature will gradually approach the displayed temperature.
- To clean the interior surface, use lukewarm water or a diluted neutral detergent and a soft cloth. Do not use brushes, acid, gasoline, soap powders, polish or hot water. These materials may damage the paint surface or plastic and rubber parts. Do not use volatile solvents to wipe plastic or rubber parts.
- If the unit is not used for long periods of time, disconnect the plug from the power source.

# INSTALLATION

## PART III INSTALLATION

### INSTALLATION ENVIRONMENT

- The Ambient temperature is 16°C~32°C, while the optimal ambient temperature is 18°C~25°C. An air conditioning system may be required to maintain ambient temperature.
- Relative humidity: ≤80%RH
- No strong vibration and no corrosive gases nearby.
- Large amounts of dust should not be present.
- No shaking or vibrating of the freezer.
- The altitude of the location of the freezer: ≤ 2000m
- Input voltage ≤110+10% (V)
- No direct sunlight or any other cooling or heating source and no electromagnetic interference or the freezer will not run properly.

### INSTALLATION SITE

This unit is meant for precision. When selecting a location to install this unit, you need the following conditions for perfect performance:

- Should not be installed in a small confined space, and the door of the room should not be less than the height of the unit.
- Install the unit on a sturdy floor to avoid excessive vibration and noise.
- Installing the unit in direct sunlight may cause malfunctioning and may shorten the life of the unit. Good ventilation is necessary.
- Socket inputs should be connected to circuit protection facilities.
- Check the working voltage of the place before starting the freezer. A voltage stabilizer is suggested to be used at the place where the voltage is not stable. Make sure the normal input voltage is stable at or 110V± 10%. Power of voltage stabilizer should be more than 4KW.
- Be sure to ground the unit; If the power cord socket is equipped with grounding wire, check the connection before use. If the power supply outlet is not grounded, it will be necessary to install a ground by qualified engineers.



#### WARNING

- Grounding through a gas pipe, water pipe, line or lightning rod can cause electric shock.
- After installation, the power plug must be within reach and convenient to unplug the power cord in case of an emergency.
- There should be no items covering the air vents of the biomedical freezer.

### CAUTIONS BEFORE USE



CAUTION: Do not put the packing plastic within reach of children as suffocation may occur

- Remove all package components (include the protection foam inside the package).
- Check the device, accessories and documents with the device as per the list of packing.
- Clean the interior surface with lukewarm water using a soft cloth.
- Before use, make sure the temperature control probe is properly immersed in the test liquid.

# INSTALLATION

## PART III INSTALLATION

### STANDING

- After unpacking, the freezer must be allowed to stand upright for at least 2 hours to allow the lubricant and refrigerant to flow back to the compressor and stabilize. Failure to do so may affect the performance and service life of the freezer.

### FOR INITIAL START

Operate as follows for the first start:

- Connect the power cord to the appropriate socket.
- Do not open the door during the cooling process. This will cause the temperature to rise.
- There must be an authorized person responsible for the freezer in the facility to check the operation status and make daily records. The inside temperature of the cabinet will rise up during a failure. If it is not available to be repaired in a short time, take out the stored items and transfer to another safe location.
- Before putting the articles inside the freezer, please check if the temperature set range of this device is matching the requirement of the articles.
- Due to the consistency of refrigeration, there is a little difference between the actual temperature displayed on the controller and the set temperature. This is a normal phenomenon.
- Biomedical Combined Refrigerator & Freezers are storage devices, do not put excessive amounts of “hot” items into the freezer at one time. This can cause compressor damage because of unnecessary overuse. It is important to put in items in batches and wait for temperature to reach desired value for next batch.
- Do not put electric devices in the freezer without permission.
- Do not change the setting temperature frequently within a short time. The actual temperature may not reach the set temperature. Do not cover sensors in the freezer when you put in samples and keep distance between the samples and the inner side of the freezer to make sure the cold air will circulate throughout the freezer. Failure to do so will cause instability of the inner temperature and inaccuracy of the display temperature.
- The freezer controller has a memory of set points. When restarting the freezer after a power failure, the freezer will continue to follow the previous operation. Restart after 5 minutes to avoid damage to the compressor.



# FEATURES

## PART IV DIAGRAM & DESCRIPTION OF FREEZER

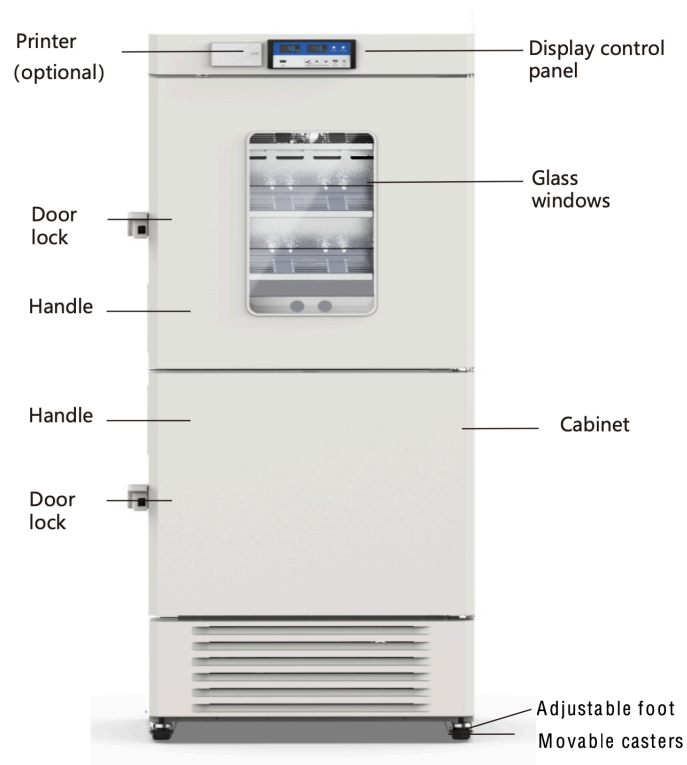

Biomedical Combined Refrigerator and Freezer

As the product is improved and the model changes, the actual product may be different from the sample diagram.

The above picture is only an example of the identifier function piece.

Structure and composition: the product consists of a box, a glass door structure, a refrigeration system, and a control system.

Scope of application: This product is suitable for hospitals, pharmacies, epidemic prevention stations, research institutions, biopharmaceutical departments and so on.

# OPERATION

## PART V DISPLAY PANEL FUNCTION DESCRIPTION

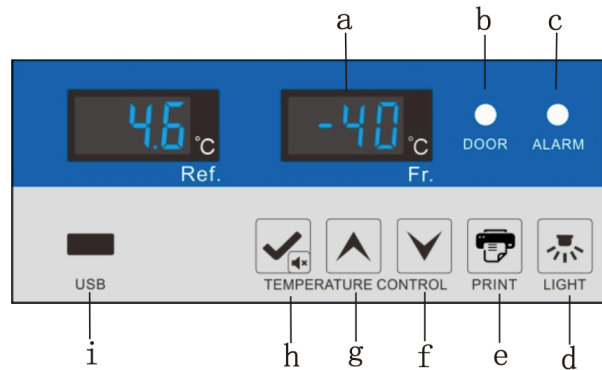

### 1. Function description of control panel



- a. The temperature display will show the average temperature of the upper chamber and the lower chamber inside the unit while under normal conditions. The temperature is displayed in Celsius.
- b. Door status indicator  
When the door opened, the light is on; when the door is closed, the light is off.
- c. Fault indicator light: When the product runs normally, the indicator light is off; The indicator light is on for operation abnormality.
- d. is the button to turn on the light.  
The default state of the lamp is off. Use this key to turn the light on and off. When off, the light will turn on when the door is open and off when closed. If turned on, the light will remain on with the door is opened or closed. The unit has two settings: automatic lighting and manual lighting. With automatic lighting, the light will turn on when the door is opened and will turn off after 5 seconds. The user can manually control the light with this button. When the light is manually turned off, the unit will enter the automatic lighting state.
- e. is the printing key.  
The system can keep the data for 7 days to print. Press the print key to print the temperature at any time.
- f. is the up key.  
In the parameter setting mode, you can move to the next parameter, or increase the parameter value. For example, when setting the set temperature, this will increase the temperature. When setting parameters, the up button will increase the amount of each parameter. In normal state, data can be imported by pressing the up key for 3 seconds.
- g. is the down key.  
In the parameter setting mode, this will move to the previous parameter or reduce the parameter value. When setting the set temperature, the temperature is reduced when pressed.

- h. is the set / mute key. Press this for the inside temperature. After 5 seconds, the normal display is restored.  
While the unit is unlocked, press for 3 seconds to enter the unit's menu.  
When the alarm is sounding (including the cabinet high temperature alarm, the door open alarm, the sensor fault alarm, etc.), press and the buzzer will stop. The display will show the temperature for 5 seconds before returning to normal display.  
While the unit is unlocked, you can use as the settings key. In the unlocked state, when setting parameter mode, press this key to display the parameter and parameter name. If the press time is longer than 3 seconds, the settings will be saved and the display will return to the normal interface.
- i. USB data export.  
**Automatic export:** when the USB disk is connected to the USB interface, the unit will buzz once, display "on", and the PDF files are generated for the current month and the last month. After the data transmission is completed, the unit will buzz once again, display "end", and then will return to normal display after 6 seconds  
**Manually export:** once the USB disk is inserted, press the for 3 seconds. The display will show "d01" and you can press up or down to select from d01-d012: previous one month to previous twelve months. Select the number of months then press to confirm the data you want downloaded.  
**Note:** when the digital display flickers "LoF", the recorder has not started; press at the same time, the "LoF" will disappear after 3 seconds, the buzzer will sound once, and the recorder will start.



## 2. Functional settings:

A. Connect the power supply and flip the power switch located on the back of the unit. The unit will then enter the normal working state.

B. To access user parameter settings, first unlock the unit.

**To unlock:** under normal operating conditions, press   for 3 seconds at the same time, the digital display will show PS1 in the upper chamber and the code "0000" in the lower chamber, enter the default password "0005" (if the password is changed, enter "0099" to restore the default lock password back to "0005"). It is unlocked at this time.

After unlocking, press  for 3 seconds, the digital display will show the

parameter code "PS1", enter the desired parameters. Use   to adjust.

Display→PS1→b1→b2→Set1→H01→L01→Set2→H02→L02→n→y→r→S→F→Pt→tH1→P1→Ps1.

Press  to confirm the parameters, the display name of the type of parameter will be displayed.

(1) scroll through parameters with  or ;

(2) select to show corresponding parameter value;

(3) use  or  to increase or decrease the value;

(4) press  to return to the parameters menu.

(5) if other parameters need to be modified, repeat step 1 ~ (4);

(6) press  for 3 seconds to store the changed and return to the parameters menu

C. If there is no button pressed for 60 seconds, the parameters menu will be exited.

# OPERATION

## D. Parameter display.

Serial Number	Menu	Parameter Range	Suggest Setting Values	Remarks
1	b1	--	1.0	Hardware version
2	b2	--	1.0	Software version
3	Set1	0~10	5.0	upper chamber refrigerator temperature setting
4	H01	0.0 ~ 10.0	5.0	High temperature alarm set value +H; H=0 when the alarm is cancelled. When the temperature is too high, the high temperature alarm shows H01
5	L01	0.0 ~ 10.0	5.0	Low temperature alarm set value -L; L=0 when the alarm is cancelled. When the temperature is too low, the low temperature alarm shows L01
6	Set2	-10~-40	-40	Lower chamber freezer temperature setting
7	H02	0.0 ~ 10.0	5.0	High temperature alarm set value +H; H=0 when the alarm is cancelled. When the temperature is too high, the high temperature alarm shows H02
8	L02	0.0 ~ 10.0	5.0	Low temperature alarm set value -L; L=0 when the alarm is cancelled. When the temperature is too low, the low temperature alarm shows L02
9	Pt	0 ~ 240min	20	Print interval
10	tH1	20.0 ~ 50.0°C	40	Upper limit of high temperature alarm
11	P1	1: Automatic heating mode 1 2: Automatic heating mode 2 3: Automatic heating mode 3 4: always on 5: always off	1 the door body with condensation is set to 4	Mode 1: When door is closed, it will automatically heat the window for 5 minutes. If during this period, the door is open and closed again, the heating time will start from the beginning. Mode 2: When the compressor is running, the heater is on; when the compressor is off, the heater is delayed for 1 minute. Mode 3: When the humidity in the cabinet is greater than 80%, the door is heated. Once the humidity is less than 60%, the heater will stop. Mode 4: The door heating is always on. Mode 5: The door heating is always off.
12	PS1	0000~9999	0005	User menu password settings

## E. Alarm Display

Alarm code	Issue description
<b>H01</b>	Upper chamber high temperature alarm
<b>L01</b>	Upper chamber low temperature alarm
<b>H02</b>	Low chamber high temperature alarm
<b>L02</b>	Low chamber low temperature alarm
<b>H03</b>	High ambient temperature alarm
<b>Door</b>	Door open alarm
<b>PF</b>	Power failure alarm
<b>bL</b>	Low battery alarm
<b>EE</b>	Communication failure
<b>E2</b>	Upper chamber temperature sensor alarm
<b>E4</b>	Lower chamber temperature sensor alarm
<b>ER</b>	Recorder is not connected
<b>Pr</b>	USB Data logging failure
<b>LoF</b>	Recorder did not start

Once the power supply is switched on for the biomedical freezer, do not immediately add items. The unit needs to operate for a period of 24 hours before the items can be stored in the freezer.

If the item you are adding has too much water or if excessive drying will change the humidity of the unit, it is best to have the item thoroughly sealed. The humidity of the freezer will affect the heating of the door.

When storing items, start by adding only 1/3 of the unit's capacity. Wait for the temperature to return to desired setting (up to 24 hours), then add enough items to fill another 1/3 capacity.

When adding items, do not block access to other items stored in the unit.

Let the cooling process happen for as long as possible before opening the door. This will cause the temperature to rise.

Due to the location of the thermostat, the unit might have slightly different temperatures than what appears on the display. This is normal and the unit will take time for the temperature to balance throughout the unit.

Note: children should not play in or around the biomedical freezer.

# MAINTENANCE

## PART VI MAINTENANCE



### CAUTION

- For personal safety, please unplug the power supply before any maintenance!
- Don't inhale medications or aerosols around the device or it will endanger your health. The biomedical freezer is direct-cooling and may have the risk of icing. It is recommended to observe the thickness of the ice and remove it in time (usually 30 days at 25 °C).

### Defrost, Unused, and Maintenance

- The biomedical freezer will automatically defrost during the working process.
- Unused: If the unit is not used for long time, please disconnect power supply and keep up the maintenance.
- Maintenance: Every so often, the biomedical freezer should be cleaned and maintained. For the sake of safety, first unplug the unit. Then wipe the inner and outer surfaces of the freezer with a soft cloth.

### CAUTION:

- DO NOT sprinkle water on the surfaces of the unit. This may decrease insulating property of electric parts and could cause rust.
- DO NOT use hot water, corrosive cleanser, or organic solvent!
- Avoid intense vibration or collision with unit during transportation. Keep out of rain.  
Suitable conditions: temperature: - 40°C ~ + 55°C, relative humidity: 10% ~ 90%.

### Disposal

Warning:

If the equipment is stored in unsupervised areas for a long period of time and left unused, ensure that children cannot access the biomedical freezer.

The disposal of the freezer shall be carried out by corresponding personnel to prevent the occurrence of such accidents as suffocation.

# AFTER-SALE SERVICE

## PART VII AFTER-SALE SERVICE

Please observe the correct operation of this biomedical freezer. If there is any issue, please troubleshoot the error with the following table. If the issue cannot be fixed, please inform our service center. We will serve you as quickly as possible to avoid any loss items or time.

PROBLEM	POSSIBLE CAUSE
Freezer is not running	Power outage has occurred The plug is bad or not securely plugged-in Fuse is blown Voltage is too low or high
Compressor is not running	Power in control panel is off Temperature setting is wrong
The temperature does not reach the set value	The door is not closed properly or is opened too frequently There is too many items in the unit Outside temperature is too high
Loud noise	The unit is not level The unit is leaning on a wall
Surface condensation on door	When the weather is humid, condensation might collect on the door. This can be expected. Wipe condensation with dry cloth.
The door is not closed properly, and the cool air leaks	After the freezer is used for a period of time, the door seal becomes hard and deformed. Maintenance method: Blow the deformed part of the hot seal with a blower to soften it, and then close and compress it after the door seal becomes soft.
Alarm flashing, buzzing	If you just put in an item, the temperature will need to stable and the alarm will reset automatically after running for a period of time. If the door is not closed tightly, the door open alarm will sound. If the battery is low, the alarm will flash and will turn off after a period of time. Alarm will flash when the temperature exceeds the set temperature.

The below may happen during normal operation:

- There are some light noises when the compressor starts up and stops.
- After opening the door and placing in hot items, the control system will show high temperature and/or high humidity alarm.  
**Solution:** hot items should be cooled by natural cooling before placing in unit. Do not put too many items in at one time. After the temperature is stabilized, the high temperature and/or high humidity alarm will turn off.
- You will hear the sound of running water through the refrigerant pipes.
- Before calling the service engineer, please clean and disinfect the refrigerator.  
Condition: do not shake heavily or strike. Avoid rain or other water drenching the unit.  
Storing environment temperature:-40°C~+55°C, Relative humidity: 10%~ 90%.

# AFTER-SALE SERVICE

## Annex1: Rechargeable Battery Maintenance, Installation, Replacement and Disposal

During long term power failure or in the process of transportation, the main power switch must be turned off. Otherwise, this could cause battery loss or permanent damage, and may not work normally after returning power to unit.

Maintenance of rechargeable batteries: In order to prolong the battery life, please avoid idling the product. It is better to run the product more than 24 hours monthly to recharge.

### Battery Maintenance

A. If you are not using the freezer for long periods of time, you should plug in the unit once a month and turn on the power. Let the battery recharge for at least 24 hours before turning back off and unplugging.

B. If the power supply is interrupted, you should switch the unit off. Failure to do so can cause the battery to lose power and possibly have permanent damage.

C. The life of the battery is about 2 to 3 years. If you near the end of the battery life or if it is not properly used, the low battery alarm will sound. This will not affect the usage of the freezer but can cause alarm failure and problems with printing functions. Contact after-sales service staff to replace the battery.

1. Battery Installation Position: Top inside of electrical box

2. Battery replacement

a. Turn off the power switch and unplug the unit from the socket. (Power supply must be off and unplugged before opening the electrical cabinet. This cabinet should only be opened by a qualified engineer or maintenance personnel).

b. Remove the battery connection plug. (Before unplugging the cord, make note of the sequence of the battery's positive and negative connections and their lines. Do not reverse these when installing new battery to prevent control system damage. The red line should be connected to the positive pole, the black line to the negative pole.)

c. Remove the two screws from the battery plate with screwdriver then remove the battery.

d. New replaced battery model: BT-12M4.0AC(12V4.0AH);

e. The replacement battery is recyclable, please contact a local battery recycling agency for processing.

**Note:** In order to ensure that the replacement battery meets the requirements of the control system and to avoid the consequences of improper replacement and operation, it is recommended that you contact the after-sales service staff to help with replacement.

## Annex2: Installing the printer paper for the optional printer

### Automatic printing:

When the printing interval Pt is not 0, the printer prints the current data every Pt minutes.

Note: When the printing interval Pt is less than the recording interval SCy, it is printed according to the recording interval; the remaining printing intervals are printed as an integral multiple of the recording interval SCy, that is: the printing interval Pt should be set as an integral multiple of the recording interval.

### Manual printing:

When the key is unlocked and the working voltage is normal, press the print key to display "P01" by the digital tube, press the up key or down key to adjust "P00~P07." Press the set/mute multiplexing key or print key, and the printer will cancel the manual printing (P00) or print the data recorded in the previous days (1 ~ 7), with the data interval same as the automatic printing interval.

### Printer Paper:

The printing paper comes pre-installed. When the printer is out of paper, you can replace it with the same type of paper. The installation steps are as follows:

1. Press the cylinder button on the printer and open the cover of the printer.
2. Put print paper into the printer box and pull the paper roll end out of the printer cover.
3. Replace the cover of the printer.

## Annex3: Remote alarm terminal and RS485 interface

The remote alarm terminal is installed in the back of freezer and the alarm signal output is by the terminal. The terminal bearing capacity is DC 30V, 2A.

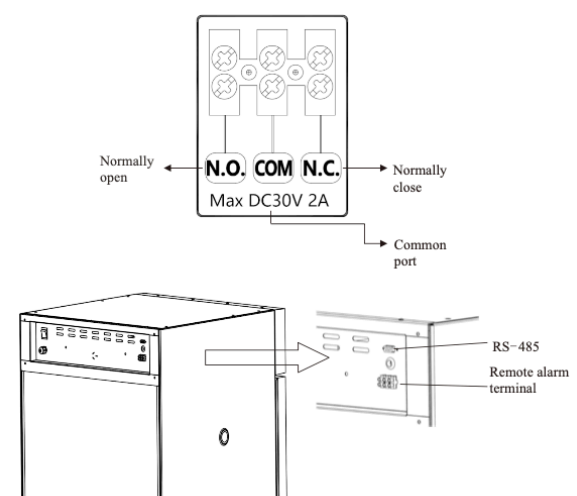



# SPECIFICATIONS

## PART VIII SPECIFICATIONS

Model Number	MLRF289	MLRF450
<b>Capacity(L)</b>	289, R:189,F:100	450,R:225,F:225
<b>Internal Size(W*D*H)mm</b>	R:600*510*670, F:500*460*505	R:650*570*627, F:650*570*627
<b>External Size(W*D*H)mm</b>	745*650*1845	810*735*1960
<b>Package Size(W*D*H)mm</b>	812*747*2004	895*820*2035
<b>NW/GW(Kgs)</b>	143/165	146/159
<b>Performance</b>		
<b>Temperature Range</b>	R:2~8, F:-10~-40	R:2~8, F:-10~-40
<b>Ambient Temperature</b>	16-32°C	16-32°C
<b>Cooling Performance</b>	R:4, F:-40	R:5, F:-40
<b>Climate Class</b>	N	N
<b>Controller</b>	Microprocessor	Microprocessor
<b>Display</b>	Digital display	Digital display
<b>Refrigeration</b>		
<b>Compressor</b>	2pcs	2pcs
<b>Cooling Method</b>	R: Forced air cooling , F:Direct cooling	R: Forced air cooling , F:Direct cooling
<b>Defrost Mode</b>	R:Automatic, F:Manual	R:Automatic, F:Manual
<b>Refrigerant</b>	R:R600a,F:290	R:R600a,F:290
<b>Insulation Thickness(mm)</b>	R: 50, F: 100	R: 80, F: 80
<b>Construction</b>		
<b>External Material</b>	Carbon steel spraying	Powder coated material
<b>Inner Material</b>	304 Stainless steel	Aluminum plate with spraying
<b>Shelves</b>	R:3+1(Stainless steel),F:3(ABS)	R:3(coated steel wired shelf),F:6(ABS)
<b>External Lock</b>	Yes	Yes
<b>Lighting</b>	LED	LED
<b>Access Port</b>	2pcs. Ø 25 mm	2pcs. Ø 25 mm
<b>Casters</b>	4 (2 caster with brake) + (2 leveling feet)	4 (2 caster with brake)
<b>Data Logging/Interval/Recording Time</b>	USB/Record every 10 minute / 2 years	USB/Record every 10 minute / 2 years
<b>Backup Battery</b>	Yes	Yes
<b>Door with Heater</b>	Yes	Yes
<b>Alarm</b>		
<b>Temperature</b>	High/Low temperature,High ambient temperature	High/Low temperature,High ambient temperature
<b>Electrical</b>	Power failure, Low battery	Power failure, Low battery
<b>System</b>	Sensor error, Door ajar, USB datalog failure, Communication failure, Remote alarm	Sensor error,Door ajar,USB datalog failure
<b>Electrical</b>		
<b>Power Supply(V/HZ)</b>	110V±10%, 60Hz	110V±10%, 60Hz
<b>Rated Current(A)</b>	3.07	3.05
<b>Options Accessory</b>		
<b>System</b>	RS232	Printer, RS485, RS232 Remote alarm contact

## BIOMEDICAL COMBINED REFRIGERATOR & FREEZER

# SPECIFICATIONS

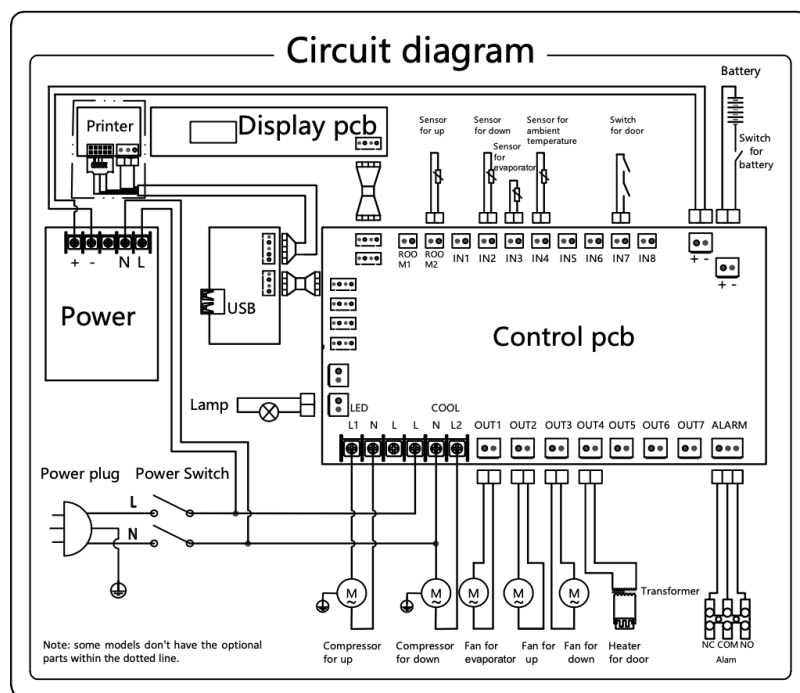

## PART IX WARRANTY INFORMATION

Please speak to your retailer before calling us if you did not purchase your freezer directly from KingsBottle.

**WHO IS COVERED:** This warranty is extended only to the original end-user purchaser or the person receiving the product as a gift, and shall not be extended to any other person or transferee.

**LIMITED WARRANTY** – If your freezer is not operating properly, KingsBottle reserves the right to repair or replace the freezer. KingsBottle may request the consumer to contact a local refrigeration company to service the freezer. All cost for labor and materials is covered for 2-year from the date of receipt. If KingsBottle deems the unit not repairable, KingsBottle will use the value of your original order toward a replacement (Any replacement unit will follow the warranty terms of the initial purchase). For customer service, please e-mail us via [hello@kingsbottle.com](mailto:hello@kingsbottle.com).

**THE LIMITED WARRANTY DOES NOT COVER:** Damage due to such things as an accident, misuse, abuse, mishandling, neglect, unauthorized repair or any other cause beyond the control of the seller whether similar or dissimilar to the foregoing. Purchaser understands and acknowledges that the goods sold here are Biomedical Combined Refrigerator & Freezer, which are for the storage of biological products, vaccines, drugs. Purchaser assumes all the risk of using these units, including the risk of spoilage, humidity variations, temperature variations, leaks, fires, water damage, mold, mildew, dryness and similar perils that may occur.

**SPECIAL NOTE:** Warranty is only honored for the unit which is used in the countries where the unit was initially purchased. And, if your product was purchased at any 3rd party retailer and not directly from KingsBottle, we do not offer an extended warranty policy. You **MUST** contact the retailer of purchase directly. In the event your retailer does not offer an extended warranty plan, we recommend you contact a third party warranty provider. However, regardless of point of purchase, all KingsBottle freezers/freezers are backed by a TWO YEAR manufacturer's warranty from date of sale.

# BIOMEDICAL COMBINED REFRIGERATOR & FREEZER