

**HOME**  
PROJECT

**HOME**  
PROJECT

**ALIVAR**

## The pure expression of italian beauty

---

La qualità certificata del Made in Italy Alivar, fatta di lavorazioni tradizionali e di materiali prestigiosi, diventa il valore di un arredo dove lo stile è un'esperienza concreta, una collezione nata dalla creatività formale e dalla sensibilità per la materia, un viaggio nella bellezza dello spazio contemporaneo.

Il progetto di una casa in cui ogni dettaglio è un valore unico, dove ciascun elemento è un punto d'interesse da vivere e da amare. Home Project anticipa e interpreta l'abitare contemporaneo e crea uno stile sempre attuale e che va oltre le tendenze, complice del successo della collezione è lo spirito creativo del designer Giuseppe Bavuso che coordina, disegna e progetta da anni con passione questa collezione.

The certified quality of Alivar's italian design solutions, all traditionally-made using top-quality materials, becomes the focal point of furnishings where style is an experience to be explored. A collection born from formal creativity and sensibility for materials and a journey into the beauty of contemporary spaces. Home design where each detail is unique and where each item is a point of interest to be cherished and enjoyed. Home Project anticipates and interprets modern living and create a contemporary style which is timeless. Behind the collection's success is the creative spirit of the designer Giuseppe Bavuso who has spent years passionately coordinating, planning and designing this collection.

### Home Project collection

Design and art director: Giuseppe Bavuso

**ALIVAR**

Estrema ricerca di raffinati dettagli, qualità dei materiali  
alta tecnologia unita alla qualità della dimensione artigianale.

Refined detailing and quality,  
high-tech materials  
combine with fine craftsmanship.

## La pietra che vive\_ Living stone

La bellezza senza tempo della pietra, disegnata dalla natura con texture e venature uniche e irripetibili, in tonalità e sfumature sempre affascinanti per la loro profondità.

Il pregio, che le ha dato un ruolo fondamentale nell'architettura e nel design, e le qualità tecniche, che l'hanno eletta uno dei materiali più importanti in tutte le epoche, caratterizzano le pietre e i marmi di Alivar, selezionate per elevare il design ad un rapporto privilegiato con la natura e con l'arte di creare forme originali. Nella contemporaneità c'è un'eleganza secolare.

The timeless beauty of stone, designed by nature itself with unique, specially made textures and veins and in rich tones and colours which never fail to enchant.

Its calibre, which has given it a key role in architecture and design, and its technical qualities, which have made it one of the most important materials throughout the ages, are characteristic of Alivar's stone and marble, selected to highlight the special relationship of design with nature and art to create original forms. In contemporary style there is a centuries-old elegance.



### **Metallo fascino di curve\_**

Fascinating metal. The allure of curves

Il pregio e la resistenza dell'acciaio inox per le lavorazioni estreme. La leggerezza e la lavorabilità dell'alluminio per le strutture e i dettagli. L'uso dei metalli risponde a precisi obiettivi tecnici ed estetici per unire in una perfetta simbiosi la forza e l'eleganza e portare lo stile verso sensazioni inedite.

The quality and resistance of stainless steel for extreme craftsmanship. The lightness and workability of aluminium for structures and details. The use of metal meets precise technical and aesthetic aims in order to perfectly combine strength and elegance and take style to a unique level.



### **Pelle emozioni da toccare\_**

Leather. Eccellente at your fingertips

La pelle naturale regala un'inimitabile sensazione tattile, una perfetta aderenza alle forme e un comfort straordinario, grazie alle cuciture sartoriali Alivar.

È un materiale nobile e molto resistente che con il tempo acquista ancora più valore e bellezza, diventando unico e speciale.

Natural leather offers an unbeatable feel, a perfect close fit and extraordinary comfort thanks to Alivar's tailored stitching. It is a noble and highly resistant material which over time becomes even more valuable and beautiful in its own unique and special way.



**L'essenza del legno\_**  
The essence of wood

La vitalità del legno sta nel dinamismo delle venature, nell'incantevole chiaroscuro del colore e nel calore dell'atmosfera che sa creare attorno a sé. I legni Alivar sono il frutto di una selezione accurata tra le essenze tradizionali e quelle più originali, una ricerca mossa dalla passione per questo materiale straordinario che non finisce mai di sorprendere e di ispirare il design. Arte ebanistica e natura si fondono in mobili sempre meravigliosamente attuali con lavorazioni di alta qualità. Tutti i legni vengono utilizzati nel pieno rispetto della sostenibilità ambientale.

Wood owes its vitality to the dynamic nature of the veins. Its enchanting light and shade effects and the warmth of the atmosphere it creates around itself. Alivar's wood is painstakingly chosen from traditional types of wood and more original ones, a research driven by our passion for this exceptional material which never ceases to surprise and inspire design. The art of woodwork and nature come together to create gloriously modern furniture with high-quality finishes. All wood is used in an environmentally-friendly way.



**Cuoio: segni creativi\_**  
Hide: signs of creativity

La morbidezza, l'elasticità, il piacere del tocco. Il cuoio è un materiale ad alta traspirabilità da sempre usato per il suo essere straordinariamente versatile. Nella casa Alivar, il cuoio lavorato con il gusto per l'artigianalità porta il senso deciso della natura, creando il calore del comfort con l'emozione della materia.

With its softness, flexibility and pleasurable feel, hide is a very breathable material, its extraordinary versatility making it a top choice since time immemorial. At Alivar, our hide is made with a taste for craftsmanship and has a definite natural feel to it, bringing warmth of comfort with the excellence of the material.

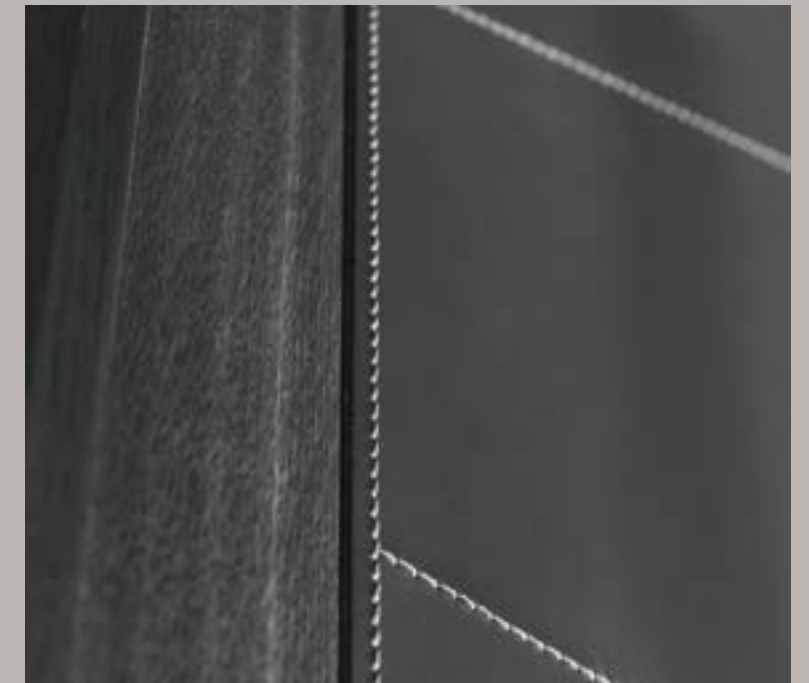

## Home Project collection

Contenuti\_contents

## Sistemi a parete Wall units

---

354 **Frame collection**  
288 **Off-Shore**

## Librerie Bookcases

---

30-92 **Diesys**  
170 **Dorothea XL**  
172 **Dorothea**  
220 **Shanghai**  
244 **Wavy**  
250 **Wavy Up**

## Contenitori Cabinets

---

150 **Tratto**  
46 **Tratto Bar**

## Porta tv Tv units

---

372 **Folio**  
374 **HF1/ HF2/ HF3**

## Divani e poltrone Sofas and armchairs

---

326 **Ascot**  
214 **Bahia**  
108 **Blow**  
142 **Cloud**  
252-256 **Daytona**  
236 **Dover**  
362 **Dublin**  
294 **Haero**  
74 **Land**  
188 **Portofino**  
12 **Swing**

## Poltroncine Armchairs

---

366 **Atlanta**  
38 **Carol**  
22 **Céline**  
302 **Club**  
206 **Dhalia**  
116 **Flexa**  
166 **Pady**  
240 **Samoa**  
338 **Wing lounge chair**

## Tavolini Coffee tables

---

300 **Bench**  
218 **Bloom**  
304 **Club**  
258 **Daytona**  
196 **Poggio**  
254 **Harpa**  
84 **Sax**  
28 **Sirio**  
64-164 **T-Gong**  
370 **Up**

## Credenze Sideboards

---

260 **Altea**  
332 **Denver**  
310 **Edomadia**  
54 **Kubit**  
272 **Portland**  
94 **Side**  
124 **Side-Up**

## Tavoli Tables

---

198 **Board**  
174 **Layer**  
40-50-86 **Liuto**  
264 **Loto**  
334 **Radar**  
270 **Stone**  
306 **XT**

## Sedie Chairs

---

268 **Axia**  
44 **Denise**  
178 **Fedra**  
120 **Flexa-chair**  
204 **Shine**  
204 **Shine-B**  
342 **Wing chair**

## Letti Beds

---

128 **Arca**  
60 **Bohème**  
278 **Blade**  
344 **Echo**  
320 **Feng**  
228 **Join**  
314 **Kendo**  
208 **Oasi**  
208 **Oasi plus**  
180 **Maya**  
376 **Plaza**  
98 **Suite**

## Complementi notte Bedroom complements

---

318 **Edo**  
284 **Esprit**  
348 **Fjord**  
322 **Frame**  
102 **Inside**  
232 **Kube**  
136 **Meridien**  
68 **Skin**

---

**Finiture & Colori**  
**Colours and finishing 378**

---

**Pagine tecniche**  
**Technical sheets 381**

---

**Alivar in the world 420**

## Timeless appeal

---

Stanze trasformate dal tempo ma che ancora lasciano trasparire il loro notevole valore architettonico e danno vita a veri "contenitori di bellezza".

Oggetti d'arredo in perfetto equilibrio tra passato e presente che fanno rivivere storie ed emozioni.

Personalizzazione e originalità sono le due parole chiave che definiscono la collezione HOME PROJECT, un percorso estetico e progettuale in cui Alivar ha lavorato sempre affiancata dall'architetto Giuseppe Bavuso.

Rooms transformed by time that still express their exceptional architectural value, becoming true "containers of beauty".

Furnishings in perfect harmony with the past and the present, that tell stories and express emotion.

Personalisation and originality define the HOME PROJECT collection, an aesthetic and design process in which Alivar worked hand in hand with Architect Giuseppe Bavuso.



## Swing divano \_sofa

Swing: imbottito dalle forme essenziali, un perfetto equilibrio tra design minimale, sofisticata eleganza e comfort. Un divano che sorprende per la sua lavorazione e per l'estrema comodità. Flessibile e funzionale, Swing può essere dotato di un piano d'appoggio multifunzionale. Una vera isola di relax per la zona living per vivere lo svago, la lettura.

---

Swing: upholstered in elegant, simple shapes, for a perfect balance between minimalist design, sophisticated elegance and comfort.

A sofa with surprising workmanship and extreme comfort.

Flexible and functional, Swing can be equipped with a multi-purpose stand.

A veritable island of relax for the living area for leisure, reading, and more.

timeless appeal \_location 1





Swing divano\_sofa

Divano e dormeuse SWING.  
Rivestimento in pelle e tavolino  
di servizio in rovere  
termotrattato. Tavolini SIRIO.

SWING sofa and dormeuse.  
Leather cover, service table  
in heat-treated oak.  
SIRIO coffee tables.

timeless appeal\_location 1





Sapiente gioco di proporzioni, seducenti pellami, materiali tattili si mixano e creano atmosfere suggestive e senza tempo. Swing: grazie alla sua infinita modularità crea soluzioni di grande charme sia per ambienti domestici che pubblici.

---

Swing: playful proportions, seductive leathers and tactile materials skilfully merge to create lovely, timeless spaces. Thanks to its infinitely modular styling, Swing comfortably fits in with any setting to create attractive solutions for both the home and public spaces.

## Swing divano \_sofa

L'originalissima conformazione di una dormeuse classica, con piano di servizio, rende questo elemento straordinariamente comodo. Lasciati conquistare dalla morbida seduta di un complemento d'arredo, capace di assolvere alla funzione di sofà. In questa pagina nella versione con piano in rovere termotrattato.

---

This element's unique chaise longue design with a service ledge makes it extraordinarily comfortable. Relax in the comfort of a furnishing accessory that eliminates the need for a sofa. Here, with a heat-treated oak top.



timeless appeal\_location 1



## Swing divano\_sofa

Complementi coordinabili al divano per personalizzare il proprio comfort attraverso una serie di combinazioni dalle linee pulite ed essenziali. In questa pagina il tavolino con piano in Marmo Calacatta oro. Un elemento perfetto anche per composizioni angolari.

---

Accessories are matched with the sofa to personalise your comfort in a series of combinations with clean and simple lines. Here, with side table featuring a gold Calacatta marble top. Perfect for corner compositions.



timeless appeal\_location 1



Céline poltroncina\_armchair

timeless appeal\_location 1

Poltroncine CÉLINE,  
rivestimento in pelle con base  
in legno. Tavolini SIRIO.

CÉLINE armchairs, leather  
cover and wooden base.  
SIRIO coffee tables.



## Céline poltroncina\_armchair

Oggetti d'arredo capaci di suscitare emozioni a prima vista. Céline, elegantissima bergère, pronta ad offrire comodità e benessere. La cucitura a vista nei profili della sua forma è un dettaglio ricercato, frutto della migliore tradizione artigianale italiana. Linea dolce e curviforme in perfetta armonia con l'atmosfera rarefatta che la circonda. Accomodatevi...

Furniture items that create excitement at first glance. Céline, an elegant bergère chair, combining comfort and a feeling of well-being. The visible stitched edging is a stylish detail, created by Italy's finest tradition of craftsmanship. Soft and curved lines in perfect harmony with the refined atmosphere surrounding it. Sit down and relax...



## timeless appeal\_location 1



## Céline poltroncina\_armchair

Céline può avere piedi in acciaio cromato, verniciato, inox finitura peltrox, nickel nero o in rovere verniciato.

Ad esaltarne la raffinatezza le cuciture tono su tono, disponibili anche a contrasto.

---

Céline is available with legs in chromed or painted steel, Peltrox-finished stainless steel, black nickel or painted oak. The tone-on-tone or contrasting stitching heighten its sophisticated nature.



timeless appeal\_location 1



## Sirio tavolini\_coffee tables

Sirio è un programma di raffinati tavolini caratterizzato dall'estrema pulizia formale e dalla modernità dei materiali pregiati utilizzati. La forma del top a vassoio ed i leggeri spessori della base d'appoggio sono il risultato perfetto di un ricercato equilibrio tra tecnologia e high-design.

Sirio is a collection of occasional tables defined by their extreme, formal clean lines and by the modern and refined materials used to create them. The tray top's shape and the slender base are the exceptional result of a skilful balance between technology and high design.



## timeless appeal\_location 1





Elementi grafici e scelte di arredo molto precise per questa prestigiosa Location. I riferimenti stilistici attraversano epoche e stili passati fino ad arrivare ai giorni nostri, ma il risultato finale è una serie di ambienti inaspettati e molto contemporanei. È una casa lussuosa e spettacolare con continui cambi di scena.

---

Specific, carefully chosen graphic elements and furnishings for this prestigious location. The stylistic references travel through the ages from past styles to modern day, but the end result is a series of unusual and very contemporary ambiances. A luxurious and spectacular home with constant scene changes.



Moduli ritmati in modo armonico, realizzati con materiali preziosi e naturali. Il cuoio, le venature del legno ed i metalli spazzolati si mixano per un look lussuoso per Diesys.

Harmoniously rhythmic modules made from precious and natural materials. Hide, the grain of wood and brushed metals are mixed for a luxurious look for Diesys.

## Diesys libreria\_bookcase

Libreria DIESYS in rovere nero poro aperto con cassetti in cuoio nero.

Poltroncina CAROL: improvvisi lampi di colore che esaltano la personalità dell'ambiente.

In questa pagina rivestimento in pelle e base in acciaio inox finitura Peltrox.

DIESYS bookcase in black oak open pore with drawers in black hide.

CAROL armchair: sudden bursts of colour that exalt the personality of the environment itself.

In this page: leather cover and base in stainless steel Peltrox finish.

timeless appeal\_location 1



## Diesys libreria\_bookcase

Diesys: libreria con profilo in acciaio spazzolato o in acciaio inox dalle infinite possibilità compositive. I ripiani sono in essenza, noce "Nazionale", rovere termotrattato o palissandro.

Gli accessori in legno e cuoio.

Il gioco delle dimensioni, il semplice sovrapporsi dei moduli e l'incontro tra i diversi nobili materiali, creano un effetto, dove i vuoti e i pieni si completano armonicamente.

---

Diesys: brushed steel or in stainless steel-edged bookcase with infinite composition possibilities.

The shelves are made of Italian walnut, heat-treated oak or rosewood.

The accessories are in wood and hide.

The variety of sizes, superimposed modules and noble materials combine to create an effect where full and empty spaces complete each other harmoniously.



## timeless appeal\_location 1



## Carol poltroncina\_armchair

timeless appeal\_location 1

Voglia di eleganza ritrovata per Carol. Poltroncina dall'anima neovintage disegnata da linee arrotondate che rivisitano gli anni '50 in chiave moderna. Poltroncina dall'eleganza audace che rivela grande passione per l'attenzione ai dettagli. Disponibile con base in acciaio cromato, verniciato, inox finitura peltrox, nickel nero o in rovere verniciato.

The elegance of the past: Carol. A neo-vintage armchair with rounded lines that revisit the '50s in a contemporary way. A boldly elegant armchair that reveals our great passion for attention to detail. Available with base in chrome-plated or painted steel, in stainless steel, Peltrox finish, black nickel or in painted oak.



Liuto tavolo\_table

Tavolo LIUTO con top noce  
"Nazionale" e base in nickel  
nero. Mobile TRATTO BAR e  
sedie DENISE.

LIUTO table with top in Italian  
walnut and base in black nickel.  
TRATTO BAR sideboard and  
DENISE chairs.

timeless appeal\_location 1



Trame sensoriali per il piano in Noce "Nazionale" che impreziosisce la casa attraverso le sue mille venature. Base in nickel nero per il tavolo Liuto e per le sedie Denise, per una totale armonia progettuale.

---

The many veins in the sensory Italian walnut top add a precious note to the home. The Liuto table and Denise chairs have a black nickel base, for a harmonious design.



## Denise poltroncina\_armchair

Seduta compatta e versatile dal gusto attuale. Un segno pulito, rigoroso, essenziale. Un elemento geometrico e leggero. Progettata per usi differenti, da seduta da pranzo a poltroncina per il living o per l'ufficio. La poltroncina è realizzata nella versione con basamento d'appoggio fisso o girevole a 360°.

---

A compact and versatile chair with a modern feel. Clean, rigorous and simple lines. A geometric and lightweight piece. Designed for a variety of uses, from dining chair to living room armchair, or even for the office. This armchair is available in a version with a static or a 360° swivel base.



timeless appeal\_location 1





## Tratto Bar credenza \_sideboard

Sembrano dei "classici": la forma, le esperienze artigianali delle accurate lavorazioni superano le prove del tempo.

L'estrema linearità della forma si sposa con la calda bellezza di essenze pregiate, cuoio e marmi preziosi. Tratto è una famiglia di contenitori con cassetti e mobili bar dedicati a spazi domestici di sofisticata concezione.

---

They look like "classics", with shapes and fine craftsmanship that stand the test of time. Extreme linearity merges with the warm beauty of fine woods, leather and precious marbles. Tratto is a family of drawer units and bars designed for sophisticated home interiors.



timeless appeal\_location 1



## Tratto Bar credenza\_sideboard

Il mobile bar riscopre il momento conviviale del cocktail. Un oggetto di culto, studiato nei minimi particolari.

L'attenta costruzione degli spazi interni prevede vani porta bicchieri e portabottiglie. L'illuminazione a luce diffusa decora con grande effetto le pareti interne del mobile.

---

The bar creates an inviting atmosphere for a cocktail. A cult object designed with extreme attention to detail. Its interior is studied down to the tiniest detail with glass holders and bottle racks. The diffuse lighting decorates the inside compartment with a great effect.



timeless appeal\_location 1



## Liuto tavolo\_table

Liuto: pulizia di linee e attenta esplorazione di materiali innovativi e materie prime naturali, come il marmo, accostamenti che generano un risultato sorprendente. Protagonista al centro della stanza destinato al convivio, agli incontri. Disponibile con base cromata, verniciata o nickel nero. Piano in marmo, cristallo, Noce "Nazionale", rovere termotrattato, cemento spatolato o MDF laccato opaco. Proposto anche in versione rettangolare o quadrata.

Liuto: clean lines and attentive exploration of innovative and natural raw materials like marble pair to create a surprising result. The table becomes the room's focus, around which friendships are made. Available with chromed, painted or black nickel legs. Marble, glass, Italian walnut, heat-treated oak, spatulated concrete or matt lacquered MDF. Also available in a rectangular or square version.

timeless appeal\_location 1



## Liuto tavolo\_table

LIUTO nella versione rotonda con top in marmo Emperador e base in nickel nero.  
In abbinamento con le sedie DENISE e la madia KUBIT .

LIUTO in round version with top in Emperador marble and base in black nickel.  
DENISE chairs and KUBIT sideboard.

timeless appeal\_location 1



Kubit credenza\_sideboard

timeless appeal\_location 1

Credenza KUBIT, abbinamenti sofisticati: laccatura lucida color brown e top in marmo Emperor.

KUBIT sideboard, sophisticated combinations: brown glossy lacquer and Emperor marble top.



## Kubit credenza\_sideboard

Ecclettismo chic con tonalità monocolore per la credenza Kubit, un elemento d'arredo elegante. Dettagli e qualità la caratterizzano come la particolare lavorazione della maniglia integrata che crea un effetto di continuità con superficie laccata.

The Kubit sideboard is an elegant complement with a stylish eclectic nature in monochromatic tones. Quality and details like the unique integrated handle create continuity with the lacquered surfaces.



timeless appeal\_location 1



## Kubit credenza\_sideboard

timeless appeal\_location 1

Espressione di alto design per la madia Kubit molto capiente, con ante laterali battenti angolari e quattro cassetti centrali. Soluzioni estetiche e funzionali. Kubit, disponibile in MDF laccato o in rovere, con piano in marmo Calacatta oro, nero Marquinia, bianco Michelangelo, Emperador o in pietra Serena. Può essere personalizzata inserendo il pratico cassetto porta-bottiglie.

The epitome of top design.

Very spacious, with side doors and four central drawers. Beautiful yet functional solutions. Kubit is available in oak or lacquered MDF, with gold Calacatta, black Marquinia, white Michelangelo, Emperador marble top or with Serena stone top.

It can be personalized by inserting a practical bottle rack.



Protagonista il letto BOHÈME rivestito in pelle. Comò SKIN con struttura in rovere termotrattato rivestito in cuoio color fango e top in marmo Emperador. Tavolini T-GONG in finitura rame e Peltrox. Poltroncina CÉLINE.

The centrepiece is the BOHÈME bed upholstered in leather. SKIN chest of drawers with a heat-treated oak frame covered in mud-coloured hide with an Emperador marble top. T-GONG side tables with a copper and Peltrox finish. CÉLINE armchair.



## Bohème letto\_bed

Un ambiente notte ispirato dal design più ricercato. Dedicato a chi cerca atmosfere eleganti e sofisticate. Letto Bohème, vero protagonista che assicura un'elevata qualità del riposo. Rivestimento in preziosa pelle e impunture capitonné che disegnano con stile la testata. Lavorazioni artigianali che danno vita a collezioni d'arredo che si pongono oltre il trascorrere delle mode.

---

A night-time atmosphere inspired by the most refined design. Dedicated to those seeking elegant and sophisticated spaces. The Bohème bed, your night-time companion providing exceptional sleeping comfort. The stylish headboard is upholstered in fine leather with tufted stitching. True craftsmanship brings furniture collections to life, freed from the confines of fashion.



timeless appeal\_location 1



## T-Gong tavolino\_coffee table

Unicità è la parola chiave per descrivere T-Gong. Un tavolino dalla particolare lavorazione metallica del piano arricchito da inserti in ottone satinato. Questo elemento d'arredo multifunzionale si presta ad essere utilizzato come tavolino o come comodino nella zona notte.

In grado di fondersi in ambienti contemporanei come in ambienti classici.

---

“Unique” is the word that best describes T-Gong. The table's unusual metal top has satin brass inserts. This multi-purpose item can be used as an occasional table or as a bedside table.

It blends in with both contemporary and classic environments.

timeless appeal\_location 1



## T-Gong tavolino\_coffee table

Elegantissimo nella versione finitura rame per piano e basamento.

Il prodotto è reso unico per la scelta delle finiture.

Disponibile anche in acciaio verniciato bronzo metallizzato satinato o in acciaio inox finitura Peltrox.

---

Extreme elegance in the version with the copper-finished top and base. The choice of finishes makes this item truly unique.

Also available in painted steel, satin metallic bronze or stainless steel with Peltrox finish.



## timeless appeal\_location 1



**Skin** complemeni notte\_bedroom complements

Skin contenitori dedicati alla zona notte caratterizzati con preziosità dei materiali e dall'accuratezza delle lavorazioni che esprimono appieno i valori del 'Made in Italy'.

Skin cabinets for the bedroom are made with fine materials and craftsmanship fully expressing the quality of "Made in Italy".

timeless appeal\_location 1



**Skin** complementi notte\_bedroom complements

La collezione notte Skin fra essenzialità di forme ed eleganza dei materiali. Propone comò con cassetti o mobile con accessori per il make-up, che ritorna ad essere un -must have-. Top dotato di specchio applicato e ribaltina che nasconde un vano per ordinare cosmetici, gioielli.

The Skin night collection combines simple shapes and elegant materials. A chest of drawers or unit with accessories.

A dressing table with accessories for make-up is once again a must. Top with a mirror and flip top to tidily tuck away cosmetics and jewellery.



**timeless appeal**\_location 1



## Natural beauty

---

Uno scrigno modernista che si apre all'aria aperta per un dialogo continuo tra indoor e outdoor.

Lo spettacolo si accende ogni giorno quando la luce filtra dalle vetrate e avvolge di calore l'interno.

Uno sfondo neutro dalle geometrie ordinate dove diversi ambienti comunicano tra di loro, l'ariosità è tipica da open space, ma con privacy garantita.

Una scelta di arredo contemporanea che lascia gli ambienti abbastanza vuoti per valorizzare l'architettura degli spazi e la diffusione della luce naturale.

A modernist open-air jewel case for a continuous dialogue between indoors and out.

The performance begins each day when the light filters through the glass, enveloping the interior in its warmth.

A neutral background with tidy geometric shapes where various environments communicate, creating the airy feel typical of open spaces, but guaranteeing privacy.

A contemporary design choice leaves spaces quite empty to focus on the architecture and allow the diffusion of natural light.



Land divano\_sofa

natural beauty\_location 2

Divano LAND rivestimento in pelle con base cromata.  
Tavolini SAX.  
Poltroncina CAROL.  
Libreria DIESYS.

LAND sofa with leather cover and chrome-plated base.  
SAX coffee tables.  
CAROL armchair.  
DIESYS bookcase.



## Land divano \_sofa

Qualità, comfort su misura e una cura sartoriale per i dettagli, come le cuciture "punto cavallo" che disegnano i profili del divano.

Land un classico intramontabile dell'arredamento. Un 'pezzo' che dura una vita, dall'aspetto solido e lussuoso, dato proprio dal prezioso rivestimento.

---

Quality, custom comfort and fine tailoring in the details, like the blanket stitch edging the sofa.

Land is a timeless furniture classic. A piece that will last a lifetime, with a solid and luxurious appearance created by its fine upholstery.

natural beauty\_location 2







Divani LAND, rivestimento in pelle e base cromata. Tavolini SAX. Poltroncine CAROL.

LAND sofas, leather cover and chrome-plated base. SAX coffee tables. CAROL armchairs.

## Land divano \_sofa

La ricerca dell'eccellenza, la cultura del bello animano ogni creazione Alivar. Una sinergia tra forme e dettagli seducenti. Il divano Land ha rivestimento in pelle o tessuto e piedi in acciaio cromato, verniciato, inox finitura Peltrox o nickel nero. In perfetto abbinamento con i tavolini Sax.

---

The search for excellence and the cult of beauty animate each and every Alivar creation. A synergy of forms and seductive details. Land sofa with cover in leather or fabric. Feet in chrome - plated or painted steel, in stainless steel Peltrox finish or black nickel.

natural beauty\_location 2





Colori delicati e materiali morbidi al tatto vestono di poesia il salotto.  
Divano Land con tavolini Sax, un complemento di classe, frutto di una semplicità progettuale evoluta.  
Nel segno della ricchezza dei materiali e delle finiture.

---

Delicate colours and soft materials give the lounge a poetic feel.  
Land sofa with Sax coffee tables are fine accessories, the fruit of evolved design simplicity.  
All typified by fine materials and finishes.



## Sax tavolini\_coffee tables

Sax: una collezione di tavolini sorretti da un'elegante base in acciaio lucido che contrasta con i colori dei materiali del top: legno termotrattato, marmo e laccati personalizzati. Versatili soluzioni, ideali sia per la zona giorno che per la zona notte.

Sax: a collection of occasional tables supported by an elegant shiny steel base that contrasts with the colours of the top: heat-treated wood, marble and customized lacquered surfaces. Versatile solutions for the living room or bedroom.



## natural beauty\_location 2



LIUTO con top in rovere termotrattato e base in nickel nero.  
In abbinamento con le sedie FLEXA e la libreria DIESYS.

LIUTO in heat-treated oak top and black nickel base with FLEXA chairs and DIESYS bookcase.



## Liuto tavolo\_table

Tratti essenziali e minimalismo formale disegnano questo tavolo dal perfetto equilibrio.

Il top è disponibile in marmo, cristallo, rovere termotrattato, Noce "Nazionale", cemento spatolato o MDF laccato opaco. La base cromata, verniciata o nickel nero.

---

Essential lines and formal minimalism characterise the design of this perfectly balanced table. Top available in marble, glass, heat-treated oak, Italian walnut, spatulated concrete or matt lacquered MDF. Chrome-plated, painted or black nickel base.



## natural beauty\_location 2



Liuto tavolo\_table

natural beauty\_location 2

LIUTO nella versione top in cristallo e base cromata. Sedie FLEXA e libreria DIESYS.

LIUTO glass top and chrome-plated version. FLEXA chairs and DIESYS bookcase.

## Diesys libreria\_bookcase

Scelte formali e cromatiche di un sofisticato minimalismo. Liuto abbinato alle librerie Diesys con profilo in acciaio spazzolato, ripiani Noce "Nazionale" e cassetti in cuoio marrone.

Formal chromatic choices with sophisticated minimalism. Liuto paired with the Diesys bookcases with their brushed steel edging, Italian walnut shelves and brown hide drawers.

natural beauty\_location 2







Tocchi di colore e rigore geometrico. Side credenza con quattro cassetti e due ante laterali, perfetto arredo per atmosfere contemporanee.

---

Dashes of colour and geometric rigour. The Side sideboard with four drawers and two side doors, the perfect item for contemporary ambiances.

## Side credenza\_sideboard

Sobria, elegante, dominata da tonalità in scala di grigio. Credenza che si integra con totale armonia e semplicità nella casa moderna.

Side: credenza laccata con base e maniglie in alluminio brillantato o verniciato.

Top in pietra acrilica verniciata.

Sober and elegant, dominated by shades of grey. A sideboard that harmoniously blends into the modern home in complete simplicity.

Side: lacquered sideboard with polished or painted aluminium base and handles.

Painted acrylic stone top.



## natural beauty\_location 2



## Suite letto\_bed

natural beauty\_location 2

Letto SUITE rivestimento in pelle, comò e comodino INSIDE. Tavolini T\_GONG e SAX.

SUITE bed in leather, INSIDE chest of drawers and bedside table. T-GONG and SAX coffee tables.

## Suite letto\_bed

Un'ampia e sinuosa testata crea ambientazioni raffinate e suggerisce il massimo comfort e relax. Pelli pregiate e lavorazioni accurate garantiscono prodotti di alta qualità.

---

A large and curvy headboard creates a refined setting and suggests maximum comfort and relax. Prestigious leathers and precise manufacturing guarantee a high-quality product.



natural beauty\_location 2



## Inside complementi notte\_bedroom complements

La zona notte uno spazio intimo e raccolto che si racconta attraverso forme avvolgenti come il letto dalla grande testata Suite in perfetta armonia stilistica con i contenitori Inside.

---

Then sleeping area: an intimate and cozy space made of sinuous curves as the Suite bedhead, matching perfectly with Inside bedroom complements.

natural beauty\_location 2



## Inside complementi notte\_bedroom complements

Serie di complementi laccati composta da comò, comodino e settimanale. L'eleganza è valorizzata dalla forma della maniglia che garantisce continuità estetica e dalla snellezza dei piedini in alluminio verniciato o brillantato.

A series of lacquered complements with chest of drawers, bedside table and high chest of drawers. Its elegance is highlighted by the shape of the handles guaranteeing aesthetic continuity, and by the slender painted or polished legs.



natural beauty\_location 2



## Urban loft

---

Un loft minimalista ricavato da una ex fabbrica con una distribuzione unica di spazi che comunicano a diverse altezze, un grande open space che apre all'esterno attraverso grandi finestre che conservano lo spirito industriale. Uno spazio bianco pieno di luce con un arredo decisamente giovane e informale, colorato ma senza eccessi.

An urban loft based in a former old factory, an unique flat on different levels.

A huge open space full of light coming from the large industrial windows. A white bright flat decorated with young and informal colourful pieces.



## Blow divano\_sofa

Divani BLOW, poltroncine SAMOA, pouf PORTOFINO, tavolini T-GONG e tavolino POGGIO.

BLOW sofas, SAMOA lounge chairs, PORTOFINO ottomans, T-GONG and POGGIO coffee tables.

urban loft\_location 3





## Blow divano\_sofa

Divano BLOW, poltroncine FLEXA, pouf PORTOFINO, tavolini T-GONG.

BLOW sofa, PORTOFINO ottomans, FLEXA lounge chairs, T-GONG coffee tables.

urban loft\_location 3



## Blow divano\_sofa

Interpretare la storia del design per creare oggetti contemporanei: la forma del divano Blow dai morbidi contorni impreziositi dal dettaglio delle cuciture, una perfetta sintesi tra forme e funzione che creano un armonico equilibrio.

---

Interpreting the history of design to create contemporary objects: Blow sofa with soft lines which are embellished with delicate stitching, a perfect synthesis between forms and function to create a harmonious balance.



urban loft\_location 3



## Blow divano\_sofa

Credenza TRATTO, divano BLOW, poltroncine FLEXA, pouf PORTOFINO, tavolini T-GONG e tavolino POGGIO.

TRATTO sideboard, BLOW sofa, PORTOFINO ottomans, FLEXA lounge chairs, T-GONG and POGGIO coffee tables.

urban loft\_location 3



## Flexa poltroncina\_lounge chair

Segni contemporanei, proporzioni piacevoli, sedie e poltroncine che osano allegri accostamenti cromatici che danno un tocco giovane e inconfondibile agli ambienti di casa. Rivestimento in pelle o tessuto. Gambe in acciaio cromato o verniciato per la sedia, acciaio verniciato o inox finitura Peltrox per la poltroncina.

Contemporary, perfectly-proportioned chairs and lounge chairs with daring colour combinations to give rooms a youthful, unforgettable touch. Fabric or leather cover.

Chair with legs in chrome-plated or painted steel, lounge chair with legs in painted steel or in stainless steel Peltrox finish.



## urban loft\_location 3





Sottile e spesso, contrasti che armonizzano la forma e che disegnano una poltroncina vivace ed accogliente.

Slender and thick, its contrasts harmonise the form, making for a bold and cosy lounge chair.

## Flexa sedia\_chair

Tocchi di colore e bellezza essenziale,  
poltroncine ideali per un arredo  
di classe di sicuro effetto.

---

Touches of colour, timeless beauty,  
these lounge chairs are perfect  
for high-class decoration.



urban loft\_location 3





## Side\_up credenza\_sideboard

Eleganza e funzione si fondono insieme. Ecco che una semplice credenza si evolve in oggetto d'arredo freestanding con vano interno attrezzato di specchio, comodi ripiani e tre cassetti. Tutto dedicato alla zona pranzo e non solo.

---

Elegance and function become one. A sideboard which can be transformed into a freestanding object with an interior compartment featuring a mirror, shelves and three drawers. All specially conceived not only for the dining room.

urban loft\_location 3





Side\_up credenza\_sideboard

urban loft\_location 3



## Arca letto\_bed

Forma sensuale che suscita piacere tattile. Un letto dall'eleganza un po' retrò, con linee morbide ed impreziosito dalla lavorazione dell'impuntura della testata in pelle. Una zona notte di grande charme, caratterizzata da una continua ricerca stilistica.

---

Sensual design which is a pleasure to touch. A bed with a slightly retro elegance, featuring smooth lines and embellished with quilting on the headboard. An extremely charming bedroom, featuring continuous stylistic research.

## urban loft\_location 3



**Arca** letto\_bed

Letto ARCA, settimanali e comodino MERIDIEN, poltroncine FLEXA, tavolino T-GONG.

ARCA bed, MERIDIEN high chest of drawers and bedside table, FLEXA lounge chairs, T-GONG coffee table.

urban loft\_location 3



## Arca letto\_bed

Arca un vero protagonista dello spazio notte. Letto dalla forma leggera e dalla testata in pelle lavorata con bottoni in peltrox rivestiti in pelle. Disponibile anche con rivestimento in tessuto. Gambe in acciaio verniciato.

---

Arca dominates the night. Bed with a light form and leather headboard with crafted leather-covered Peltrox buttons. Also available with fabric upholstery. Painted steel legs.



## urban loft\_location 3



## Arca letto\_bed

Eleganza, esclusività caratterizzano il letto Arca dall' apparente semplicità ma che trova i suoi punti di forza nella purezza delle linee, nella preziosità dei materiali e nell' accuratezza dei dettagli.

---

Though the elegant and exclusive Arca bed may seem simple, its strengths lie in its pure lines, fine materials and attention to detail.

urban loft\_location 3



## Meridien complementi notte\_bedroom complements

Una serie di contenitori dedicati alla notte. Linee sofisticate con nuances di colore che permettono di creare decisi stacchi tra struttura e cassetti o in alternativa strutture monocromatiche.

---

A series of containers for night-time. Sophisticated lines with color shading that establish clear breaks between the frame and the drawers, or with monochromatic finish.

urban loft\_location 3



## Meridien complementi notte\_bedroom complements

Elementi singoli protagonisti  
nello spazio architettonico con  
sfumature di colore calde.  
Comodino e comò Meridien laccato  
opaco color tortora.  
Top e base in acciaio verniciato.

Each individual element plays a role  
in the architectural space with a warm  
colour palette. Dove-grey lacquered  
Meridien bedside table and chest of  
drawers. Painted steel top and base.



## urban loft\_location 3



## Space without limits

---

Oggetti caratterizzati da una forte valenza estetica che si ispirano al passato ma che parlano un linguaggio contemporaneo. Arredi che vanno al di là degli stili, declinati a materiali più vari per una scenografica estetica dal perfetto contenuto progettuale.

Stunningly beautiful objects inspired by the past but which speak a contemporary language.  
Furniture which never goes out-of-date, available in a varied range of materials for meticulously designed and beautiful surroundings.





Cloud divano\_sofa

space without limits\_location

Divani CLOUD, pouf PORTOFINO,  
tavolini T-GONG, credenza TRATTO.

CLOUD sofas, PORTOFINO ottomans,  
T-GONG coffee tables, TRATTO sideboard.

Cloud divano\_sofa

space without limits\_location 4



Divano CLOUD, poltroncine PADY,  
tavolino T-GONG e tavolino POGGIO

CLOUD sofa, PADY armchairs, T-GONG  
and POGGIO coffee tables.

## Cloud divano\_sofa

Haute-couture del design. Un divano interprete della bellezza senza tempo. Ampio e accogliente, Cloud è per sua natura avvolgente, dalle curve arrotondate e dalle forme morbide, per garantire un comfort perfetto. Divano modulare per chi ama atmosfere calde con il prezioso rivestimento in pelle.

---

The haute couture design.  
A sofa interpreter of timeless beauty.  
Roomy and welcoming, Cloud is naturally enveloping, with smooth curves and soft shapes, for guaranteed comfort. Exquisite leather modular sofa for those who love warm atmospheres.

space without limits\_location 4





Divano CLOUD, poltroncine PADY, tavolini T-GONG, tavolino POGGIO e credenza KUBIT.

CLOUD sofa, PADY armchairs, T-GONG coffee tables, POGGIO coffee table and KUBIT sideboard.

## Tratto libreria\_bookcase

Libreria Tratto, la contemporaneità che va oltre il tempo e che non segna le mode, un esempio tra artigianato e industria tutta nel segno del legno.

In questa pagina con il divano Cloud, le poltroncine Pady ed i tavolini T-Gong.

Tratto bookcase for contemporary yet timeless style that's never held back by trends, a fine example of craftsmanship and industry dressed in wood.

Here, with the Cloud sofa, Pady armchairs and T-Gong coffee tables.



## space without limits\_location 4





Libreria TRATTO, divani CLOUD, tavolino T-GONG e tavolini POGGIO.  
TRATTO bookcase, CLOUD sofas, T-GONG coffee table and POGGIO coffee tables.

## Tratto credenza\_sideboard

Tratto è un sistema di mobili contenitori per l'area living e l'area notte. Materiali di altissima qualità come il rovere tinto termotrattato si abbinano ad ante e cassetti rivestiti in cuoio, creando arredi colti e ricercati.

Tratto is a system of storage units for the living area and bedroom area. Top quality materials such as heat-treated oak are combined with hide panels and drawers, creating sophisticated and elegant furniture.



space without limits\_location 4



Tratto credenza\_sideboard

Credenza TRATTO, tavolo STONE,  
sedie SHINE e poltroncine SAMOA.

TRATTO sideboard, STONE table,  
SHINE chairs and SAMOA armchairs.

space without limits\_location 4







Una forte passione per il legno, un gusto raffinato e rigoroso. Credenza protagonista dello spazio architettonico, arricchita dalla trasparenza delle ante in cristallo e dalla luce interna che genera magici riflessi in tutta la superficie. Nella pagina a sinistra: tavolo Board e le sedie in pelle Fedra.

Strong passion for wood, elegant and formal style. A sideboard which becomes the centrepiece of any room, featuring transparent glass doors and internal light which make the entire surface sparkle with magic. Left page: Fedra chairs in leather and Board table.



**Tratto** credenza\_sideboard

Eleganza impeccabile per Tratto nella versione laccata lucida castoro e top in marmo Grigio Imperiale.

Tratto, impeccable elegance in a glossy beaver-coloured lacquered version with Imperial grey marble top.



space without limits\_location 4



## Tratto credenza\_sideboard

Tratto semplici forme esaltate dalla molteplicità delle finiture e dei colori.

Simple forms enhanced by the multitude of finishes and colours.



## space without limits\_location 4



## T-Gong tavolini\_coffee tables

T-Gong combinazione ottimale tra tecnologia industriale e ricerca creativa. In questa pagina in acciaio inox finitura Peltrox.

---

T-Gong, the perfect combination of industrial technology and creative research. Here, in stainless steel with a Peltrox finish.

space without limits\_location 4



Pady poltroncina\_armchair

space without limits\_location 4

Poltroncine PADY, tavolino  
T-GONG, libreria WAVY.

PADY armchairs, T-GONG  
coffee table, WAVY bookcase.



## Pady poltroncina\_armchair

Un segno semplice reinterpreta i classici del passato. Materiali e dettagli ricercati. Pady: le cuciture ribattute nei braccioli, sottolineano l'alta qualità dei prodotti ALIVAR. Base in acciaio laccato, cromato o in acciaio inox finitura Peltrox. Rivestimento in pelle o tessuto.

A simple style which reinterprets classics from the past. Sophisticated details and materials.

Pady : the visible stitching on the armrests highlights the quality of ALIVAR products.

Steel base, painted or chrome-plated or stainless steel base with "Peltrox" finish. Leather or fabric cover.



space without limits\_location 4



## Dorothea XL credenza\_sideboard

Il legno, il vetro e la luce: grandi suggestioni che cambiano l'atmosfera di casa. Conquista la zona living per la totale libertà di organizzazione degli interni. Dorothea XL è innovazione tecnologica nascosta dietro forme apparentemente semplici. Libreria in rovere verniciato con cassetti, ripiani in cuoio e ante in cristallo temperato. Illuminazione a LED.

Wood, glass and light: great suggestions to change the feel of your home. Conquer the living area for total interior arrangement freedom. Dorothea XL technological innovation behind a deceptively simple design. Bookcase in painted wood with drawers, hide shelves and tempered glass doors. Led lighting.



## space without limits\_location 4



Dorothea credenza\_sideboard

space without limits\_location 4

Tavolo BOARD, sedie FEDRA,  
pouff PORTOFINO e credenze  
DOROTHEA.

BOARD table, FEDRA chairs,  
PORTOFINO ottomans and  
DOROTHEA sideboards.





## Layer tavolo\_ table

Layer linee essenziali,  
bianco minimal per chi ama  
vivere nel segno della  
purezza assoluta.

---

Classic design, minimal white  
for those who love  
living in absolute purity.

space without limits\_location 4





Tavolo LAYER, sedie FEDRA, libreria WAVY e pouf PORTOFINO.

LAYER table, FEDRA chairs, WAVY bookcase and PORTOFINO ottoman.

## Fedra sedia\_chair

Fedra fatta per giocare nello spazio della casa.

Una sedia dal disegno dinamico che non rinuncia alle piccole raffinatezze artigianali.

---

Designed for playing in your home. A chair with a dynamic design but which still retains the sophistication of handcrafted details.

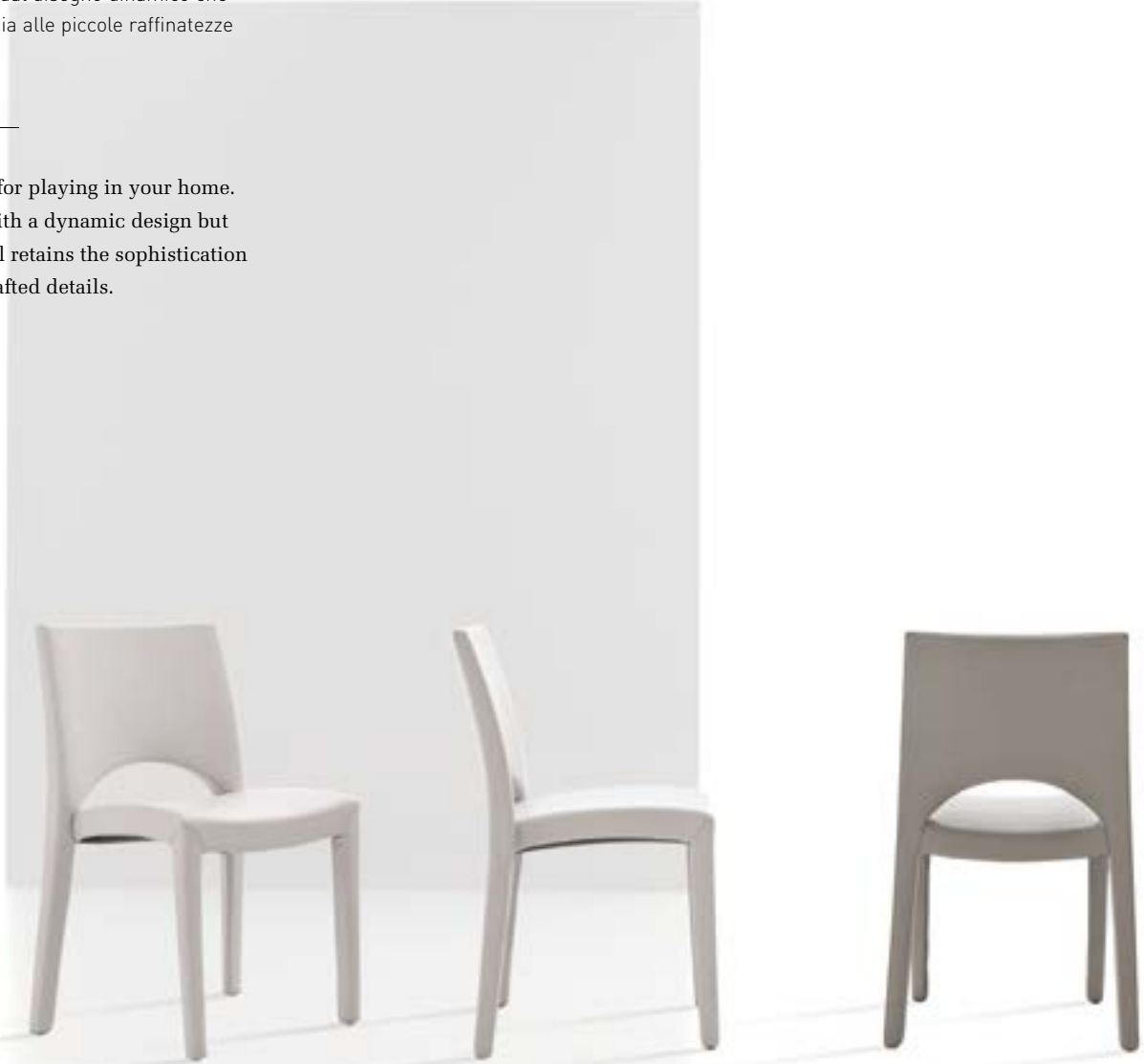

space without limits\_location 4



Maya letto\_bed

space without limits\_location 4

Letto MAYA, comò e comodini  
KUBE, tavolini T-GONG

MAYA bed, KUBE chest of  
drawers and bedside tables,  
T-GONG coffee tables.

## Maya letto\_bed

Maya elevato contenuto artistico e particolare carattere creativo, il riposo diventa simbolo di uno stile ancorato alla storia del design. Letto dalle linee avvolgenti, con testata rivestita in pelle o tessuto e impreziosita dall'accurata cucitura centrale. Piedi in pressofusione di alluminio, finitura brillantato o verniciato.

High artistic content and a unique creative character. Rest becomes a symbol of style anchored in the history of design. Maya cosy bed with leather or fabric headboard embellished with neat central stitching. Aluminium die-cast legs, polished or painted.



space without limits\_location 4



## Maya letto\_bed

Semplicità e purezza delle linee sono i punti di forza di Maya. Ideali complementi per questo letto sono i tavolini T-Gong.

---

Simplicity and pure lines are the strengths of Maya bed. Matching perfectly with T-Gong side tables.

space without limits\_location 4



## Warm atmospheres

---

L'uso del legno, della pietra, in ampie superfici riporta in casa il contatto con la natura, ispirato ai grandi orizzonti del paesaggio che ci circonda. Una casa studiata per esporre arredi e oggetti con sfumature di colori caldi che rendono suggestivo l'ambiente progettato, senza mai perdere di vista l'armonia dell'insieme.

The use of wood and stone on ample surfaces brings a little bit of nature to your home, inspired by the wide open spaces of the countryside. A home designed for displaying furniture and objects in warm shades which create evocative surroundings designed without losing sight of the idea of creating a harmonious ensemble.



Portofino divano\_sofa

warm atmospheres\_location 5

–  
Divani e pouf PORTOFINO, tavolino  
POGGIO, tavolini BLOOM, libreria  
WAVY.

PORTOFINO sofas and ottomans,  
POGGIO coffee table, BLOOM  
coffee tables, WAVY bookcase.





## Portofino divano\_sofa

Portofino: mood intimo e nuance dal gusto estremamente raffinato per creare atmosfere dominate dalla morbidezza.

---

Portofino: intimate mood and extremely refined style for creating soft surroundings.

warm atmospheres\_location 5



## Portofino divano\_sofa

Portofino forme avvolgenti che offrono uno spazio intimo. Divano che vanta un equilibrio ottimale nelle proporzioni e trova spazio in ambienti dagli stili più vari. In questa pagina nella versione componibile con chaise longue con piede laccato e pelle Nabuk. Disponibile anche nella versione con piede in alluminio lucido.

Portofino: a cosy design which provides intimate surroundings. A sofa with perfectly balanced proportions which is the perfect fit for rooms with the most varied styles. On this page the sectional sofa with chaise longue with lacquered leg and Nabuk leather. Also available in glossy aluminium leg.





## Poggio tavolini\_coffee tables

Poggio tavolini dalla multiforme collocazione, disponibili in due forme, quadrato e rettangolare. Un'ampia superficie per il piano in pietra acrilica bianca, in marmo, in rovere termotrattato o in MDF laccato.

Una snella struttura in pressofusione di alluminio brillantato o laccato.

Poggio tables with multiple uses, available in two shapes: square and rectangular.

A spacious surface for the top available in white acrylic stone, in heat-treated oak or in lacquered MDF.

A clear-cut frame in lacquered or polished die-cast aluminium.

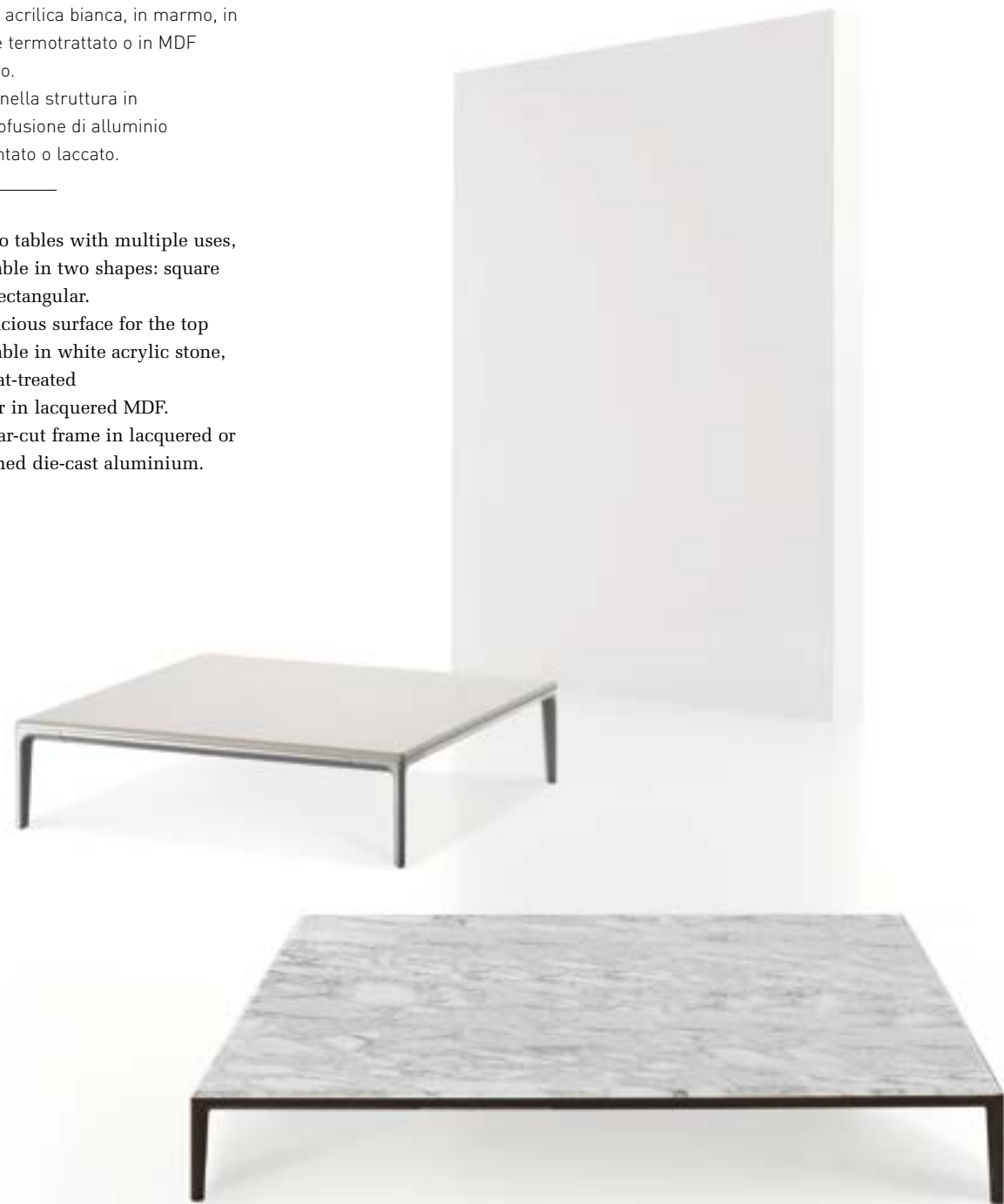

## warm atmospheres\_location 5



## Board tavolo\_table

Board un tavolo dalla forma molto elegante che evoca l'alta tradizione artigianale degli ebanisti. Il disegno sinuoso e armonico della base e la ricchezza delle finiture del piano lo fanno diventare un oggetto simbolo nel living o nella zona studio.

---

Board an elegantly-designed table with all the features of traditional high-quality cabinet making. The sinuous, harmonious design of the base and richness of the finishes on the top make it a symbolic item for living areas or study areas.

warm atmospheres\_location 5



Board tavolo\_table

warm atmospheres\_location 5

Tavolo BOARD, sedie SHINE, poltroncina SHINE\_B e credenze ALTEA.

BOARD table, SHINE chairs, SHINE\_B armchair and ALTEA sideboards.



## Board tavolo\_table

Spessori minimi e materiali che quasi si fondono tra di loro, questa è la ricerca del dettaglio ALIVAR.

Board disponibile nella versione quadrato o rettangolare, con struttura in legno laccato, in rovere finitura termo-trattato o verniciato a poro aperto. Piano in pietra acrilica bianca o in marmo.

Minimal thickness and materials which almost merge into themselves.

This is what attention to detail means for ALIVAR. Board available in a square or rectangular version, with a lacquered wooden frame, in an open-pore painted or heat-treated oak finish. Top in white acrylic stone or in marble.



warm atmospheres\_location 5



## Shine sedia\_chair

Shine: pelle, metallo  
e raffinati dettagli creano  
complementi d'arredo  
che sanno andare oltre  
le tendenze.

Shine: leather, metal and elegant  
details come together to create  
furnishing accessories with  
a timeless appeal.



warm atmospheres\_location 5



## Dhalia poltroncina\_armchair

Dhalia la classica seduta "a pozzetto" freestyle, da collocare nella zona giorno come nella zona notte. Semplicità, armonia ed equilibrio gli aggettivi perfetti per definire questa poltroncina. Disponibile con rivestimento in pelle o tessuto.

Dhalia the classic freestyle "tub" chair to furnish both living areas and the bedroom. Simplicity, harmony and balance are the perfect adjectives for describing this armchair. Available in leather or fabric.



warm atmospheres\_location 5



## Oasi letto\_bed

Letto OASI, settimanali e comodini KUBE, libreria WAVY.

OASI bed, KUBE high chest of drawers and bedside tables, WAVY bookcase.

warm atmospheres\_location 5



## Oasi letto\_bed

Oasi un piacere per la vista e un invito al relax: letto imbottito comodo e accogliente con cuscini in piuma, rivestimento in pelle o tessuto. Si abbina perfettamente al comodino Kube.

Oasi a pleasure for the sight and an invitation to relax: comfortable and cosy padded bed with feather cushions, made from leather or fabric. It matches perfectly with Kube bedside table.



warm atmospheres\_location 5



## Creative power

---

Scoprire nuovi materiali per arrivare a nuove forme, allargare i confini del comfort per reinventare il living come luogo privilegiato del relax e delle passioni, vissute con uno spiccato senso estetico. Dagli incontri inediti delle essenze e dei materiali tecnici ed ecologici nascono i nuovi segni dell'abitare.

Discover new materials to create new forms and bring a new dimension to comfort to transform your living space into a haven for relax and passion, experienced with a great sense of beauty. The unusual union between wood and eco-friendly technical materials breathes life to new ways of living.



**Bahia** divano\_sofa

Divano BAHIA  
e tavolini HARPA.

BAHIA sofa  
and HARPA coffee tables.

creative power\_location 6



## Bahia divano\_sofa

Saper coniugare valore estetico e doti di comfort. Irresistibile invito al relax. Bahia, divano dalle proporzioni accoglienti che ti racchiude come un abbraccio.

---

Where beauty meets comfort.  
Irresistible invitation to relax.  
Snuggle down on this cosy  
Bahia sofa.



creative power\_location 6



## Bloom tavolino\_side table

Bloom elementi attuali ed estremamente versatili che nascono da incontri creativi tra forma e materia.

Tavolini Bloom dedicati alla casa contemporanea.

Base in acciaio cromato o laccato.

Piano in pietra acrilica bianca o laccata.

---

Bloom side tables: modern, extremely versatile elements that are the result of creative encounters between form and materials. Bloom side tables dedicated to the modern home. Base in chrome-plated or painted steel. Top in white or lacquered acrylic stone.



creative power\_location 6







## Shanghai libreria\_bookcase

Shanghai libreria dalla forte presenza che dà carattere alla casa.

Mobili che sanno conciliare solidità, funzionalità e ricercatezza.

---

Shanghai bookcase with a strong presence that give character to the home.

Furniture that combines solidity, functionality and elegance.

creative power\_location 6





Librerie SHANGHAI,  
tavolo BOARD  
e sedia FEDRA.

SHANGHAI bookcases,  
BOARD table and  
FEDRA chair.

## Shanghai libreria\_bookcase

Design contemporaneo e materiali innovativi. Un moderno concetto di libreria dalla marcata personalità. Shanghai è ideale anche per delineare un open space. In questa pagina con struttura esterna in rovere termo-trattato. Ripiani interni in MDF rivestiti in cemento HD light cement colore "French grey". Disponibile anche con cornice legno laccato opaco e ripiani interni in MDF sistema Duxilon laccato opaco.

Contemporary design and innovative materials. A modern bookcase concept with a strong personality. Shanghai is ideal for delimiting an open space.

In this page, version with external frame in heat-treated oak. Shelves in MDF covered in HD Light Cement "French grey" colour. Available also with frame in matt lacquered wood and inner shelves in matt lacquered MDF with Duxilon process.



creative power\_location 6



Letto JOIN rivestito in pelle,  
settimanali e comodini KUBE,  
poltroncina SAMOA.

JOIN bed covered with leather,  
KUBE high chest of drawers  
and bedside tables, SAMOA  
armchair.

Join letto\_bed

creative power\_location 6



Letto Join dalle morbide  
linee avvolgenti  
è realizzato in massello di  
rovere finitura termo-  
trattato o verniciato o  
in legno laccato opaco.  
Testata imbottita con  
rivestimento in pelle  
o tessuto.

Join bed, with its snug  
lines, is available  
in heat-treated or  
stained massive oak or  
matt laquered wood.  
Upholstered headboard  
with fabric or leather  
covers.

## Kube complementi notte\_bedroom complements

Complementi notte Kube dalle linee semplicemente eleganti che esprimono stile e personalità nelle versioni in MDF laccato opaco, in rovere termo-trattato o verniciato. Top in pietra acrilica rivestito in pelle. Maniglie in pelle

Kube simply elegant bedside accessories which express style and personality in matt lacquered MDF, in heat-treated or painted oak. Acrylic stone top covered in leather. Leather handles.



creative power\_location 6



## A home full of light

La luce e la trasparenza sono il leitmotiv di una casa che "si apre all'esterno", in comunicazione con l'ambiente circostante. Il linguaggio è quello della purezza del bianco e della materialità del nero, della geometricità e dell'essenzialità di elementi dal design ricercato e dalla spiccata praticità. L'imponenza dei grandi spazi entra nella casa minimal. Brillantezza e trasparenza vestono e caratterizzano gli ambienti, per abitare a luce naturale. Il colore bianco, i materiali innovativi, il design lineare e le soluzioni altamente tecnologiche vestono e personalizzano i diversi ambienti.

The use of grand spaces are found in the minimalist homes. The atmosphere is bright and transparent, using natural lighting. The white colour, innovative materials, linear design and technological solutions are found in the various rooms. Light and transparency are the essentials of a home that "interacts with its external environment" to communicate with its surroundings. The language speaks of the purity of white and the materiality of black, of the geometrics and essence of sophisticated designer elements and outstanding practicality.



Divani DOVER, tavolini HARPA,  
poltroncine SAMOA, madie ALTEA  
e libreria WAVY.

DOVER sofas, HARPA coffee tables,  
SAMOA armchairs, ALTEA  
sideboards and WAVY bookcase.



## Dover divano\_sofa

Classico ed elegante, dal colore bianco immagine di purezza. Il gioco di volumi è impreziosito dalle cuciture ribattute.

Classic and elegant with the purity of white. The contrasting proportions are embellished by busted seams.



## a home full of light\_location 7



## Samoa poltroncina\_lounge chair

Samoa: linee dolci di seduta e schienale, spigolose e nette della base.

Un mix di stili che la rende idonea ad ogni ambiente.

---

Combining the gentle lines of the seat and back with the sharp angular lines of its base. A mixture of styles that make this armchair ideal for any time or place.

a home full of light\_location 7



## Samoa poltroncina\_lounge chair

Piacevole passe-partout, la poltroncina Samoa si distingue per la linea sinuosa di seduta e schienale qui nella versione con trama intrecciata, in contrasto con il rigore della base squadrata. Seduta e schienale sono realizzati in poliuretano rivestito a scelta in pelle, ecopelle o cavallino, mentre la struttura è disponibile in tubolare di acciaio laccato o cromato.

---

A versatile passe-partout, the Samoa lounge chair stands out for the sinuous lines of the seat and back, here in version with woven seats to contrast the sharply squared base. Seat and back are made in polyurethane foam covered in leather, synthetic leather or pony skin, while the frame is available in either painted or chrome-plated tubular steel.



a home full of light\_location 7



## Wavy libreria\_bookcase

Wavy è un sistema di librerie dalla sottile struttura.

Il disegno ondeggiante conferisce un'immagine di grande solidità e leggerezza.

---

Wavy is a system of slender-structured bookcases with a wavy structure providing a sense of great solidity and lightness.

a home full of light\_location 7



**Wavy** libreria\_bookcase

Libreria WAVY, poltroncine SAMOA, tavolo STONE e sedia WING CHAIR.

WAVY bookcase, SAMOA armchairs, STONE table and WING chair.

a home full of light\_location 7



La libreria Wavy è composta da blocchi sovrapponibili e accostabili diventando così un elemento di arredo molto elegante di estrema linearità formale. Wavy si compone in modo flessibile per soluzioni living dedicate alla casa contemporanea. Realizzata completamente in pietra acrilica naturale.

Wavy bookcase is composed of blocks that can be laid one upon another and combined thus becoming a highly elegant furnishing element with an extremely formal linear nature. Wavy can be combined in a flexible manner for living solutions dedicated to the modern home. Made entirely from natural acrylic stone.



## Wavy Up libreria\_bookcase



Wavy è componibile: in verticale per sovrapposizione con modulo H. 36 cm. e in orizzontale è costituita da elementi accostabili di diverse misure: 63 / 124 / 185 cm. In questa pagina Wavy Up, libreria sospesa.

---

Wavy may be arranged as desired: superimposed vertically with module H. 36 cm. or horizontally, composed by elements of different sizes which may be combined: 63 / 124 / 185 cm. This page: Wavy Up, hanging bookcase.

a home full of light\_location 7



## Daytona divano\_sofa

DAYTONA divano componibile. Rivestito in pelle o tessuto con base e gambe in acciaio verniciato o cromato. La forma soffice di questo divano è caratterizzata dai cuscini imbottiti in poliuretano e piuma d'oca. In questa pagina: DAYTONA in pelle bianca, HARPA tavolini e WAVY libreria modulare.

---

DAYTONA sectional sofa with leather or fabric covers. Base and legs in chrome-plated or painted steel. The soft shape of this sofa is highlighted by cushions filled with polyurethane foam and goose feathers. In this page: DAYTONA in white leather, HARPA coffee tables and WAVY modular bookcase.

a home full of light\_location 7





## Harpa tavolini\_coffee tables

Harpa unico nella sua linearità.  
A renderlo tale è il semplice  
incrocio che compone il basamento.

---

Harpa is unique in its linearity  
which is achieved by the simple  
crossover design of the base.



a home full of light\_location 7



Daytona divano\_sofa

a home full of light\_location 7



Divano e dormeuse DAYTONA, tavolini DAYTONA, tavolino CLUB e poltroncine ATLANTA.

DAYTONA sofa and dormeuse, DAYTONA coffee tables, CLUB side table and ATLANTA armchairs.

Daytona divano\_sofa / tavolino\_coffee table

a home full of light\_location 7



Daytona è anche una collezione di tavolini, nati per stare attorno all'omonimo divano. Disponibili in due misure con base in acciaio cromato o laccato. Piano in rovere o MDF laccato. In questa pagina: divano, pouff e tavolini Daytona.

Daytona is also a collection of tables designed to be used with the sofa of the same name. Available in two sizes with lacquered or chrome-plated steel base. Lacquered mdf or oak top. In this page: Daytona sofa, ottoman and coffee-tables.



Altea credenza\_sideboard

a home full of light\_location 7

Credenze ALTEA, tavolo LOTO, sedie WING CHAIR e poltroncine SAMOA.

ALTEA sideboards, LOTO table, WING CHAIR chairs and SAMOA armchairs.

## Altea credenza\_sideboard

Altea reinterpreta in chiave moderna un elemento d'arredo classico: la vetrina. I dettagli in vetro esaltano la sua naturale bellezza.

Altea gives a modern take on a classic furniture item: the display cabinet.  
The glass details enhance its natural beauty.



## a home full of light\_location 7



## Loto tavolo\_table

Concretezza e illusione, questo il messaggio del tavolo Loto, in versione rettangolare allungabile. Il piano, realizzato in legno, suggerisce robustezza e tangibilità, mentre il basamento in acciaio lucidato rimanda alla dimensione leggera e immateriale del sogno e delle emozioni. Abbinato alle sedie Wing chair.

---

Concreteness and illusion, this is the message the Loto table transmits in its expandable rectangular version. The top, made in wood, suggests strength and tangibility, while the base in polished steel evokes the lightweight and ethereal dimension of dreams and emotions. Shown with Wing chairs.



## a home full of light\_location 7



Loto tavolo\_table

a home full of light\_location 7

Loto eloquente razionalità e design dalle alte prestazioni. Bello da usare non solo per il pranzo.

---

Eloquent rationality and high-performance design. Beautiful to use not only for lunch.

## Axia sedia\_chair

Agile e dinamica, realizzata con materiali selezionati.  
Un piacevole invito ad accomodarsi.

---

Axia agile and dynamic with refined materials.  
A pleasurable invitation to sit down.



a home full of light\_location 7





## Stone tavolo\_table

Innovazione formale e tecnologica per il tavolo Stone con base in acciaio inox lucidato a specchio. Piano in marmo o in cemento Ductal® colore "French grey".  
Una nuova generazione di materiali che sono sinonimo di ricerca e qualità italiana.

Formal and technological innovation for this Stone table with mirror-polished stainless steel base. Top in marble or in Ductal® concrete "French grey" colour.  
A new generation of materials synonymous with Italian quality and elegance.



## Portland credenza\_sideboard

Portland e la lucentezza dell'intramontabile laccato lucido bianco. Ante scorrevoli e mensola superiore attrezzata con quattro cassetti. Soluzione capiente e versatile composta da ripiani a giorno e scomparti chiusi da ante scorrevoli. Disponibile in MDF laccato o in rovere e piani in marmo o pietra Serena.

The fabulous glossy white Portland with sliding doors and upper shelf with four drawers. Spacious versatile solution, made with shelves and compartments closed by sliding doors. Available in oak or in lacquered MDF, tops in marble or in Serena stone.



a home full of light\_location 7



Portland credenza\_sideboard

Credenza PORTLAND, tavolo LOTO, sedie AXIA.

PORTLAND sideboard, LOTO table, AXIA chairs.

a home full of light\_location 7



## Portland credenza\_sideboard

Portland materia lucente.  
Un volume come presenza decorativa  
nello spazio living room.

---

Portland glossy lacquered furniture  
to decorate your living room.



## a home full of light\_location 7



Letto BLADE/A, comodino e settimanali ESPRIT, poltroncine SAMOA.

BLADE/A bed, ESPRIT bedside table and high chest of drawers, SAMOA armchairs.



## Blade letto\_bed

Il letto Blade/A con la testata alta o bassa  
Blade/B con una particolare lavorazione  
lascia a vista le fettucce passanti, creando un  
effetto matelassé piacevolissimo. Disponibile  
con gambe e cornice in acciaio laccato o  
cromato. Testata e giroletto imbottiti  
e rivestiti in pelle o tessuto.

---

The Blade/A bed with high or low  
headboard Blade/B with a unique finish  
with visible passing ribbons, creating a  
lovely matelassé effect. Available with legs  
and frame in chrome-plated or lacquered  
steel. Headboard and side padded and  
upholstered in leather or fabric.



a home full of light\_location 7





Letto BLADE/B, comodino  
ESPRIT, poltroncina SAMOA e  
tavolino HARPA.

BLADE/B bed, ESPRIT bedside  
table, SAMOA armchair and  
HARPA coffee table.

## Esprit complementi notte\_bedroom complements

Cassettone, settimanale e comodino compongono la gamma dei complementi notte Esprit, contraddistinti dal top con spigolo frontale smussato e dalle maniglie incassate. Ciascun elemento è disponibile in MDF laccato lucido o opaco con base in acciaio cromato o laccato.

Chest of drawers, higt chest and bedside tables make up a range of Esprit bedroom complements, distinguished by the top with rounded front angle and flush handles. Each element is available in glossy or matt lacquered MDF with chrome-plated or painted steel base.



a home full of light\_location 7





## Design for living

---

Una casa ricca di ispirazioni, multicentrica, in cui l'essenzialità lascia gli spazi aperti e offre una vivibilità ottimale, dove "essere di tendenza" significa anticipare ciò che sta oltre l'orizzonte. L'importanza dei grandi spazi entra nella casa minimal. Brillantezza e trasparenza caratterizzano gli ambienti.

The home is inspiring and multi-centred, where the spaces are open offering an optimal living space, where being "innovative" means understanding what the future holds. Large spaces are important in minimalist homes. Luminance and transparency characterise rooms.



**Off-Shore** sistema a parete\_wall system

design for living\_location 8

Divano HAERO, poltroncine WING LOUNGE CHAIR, tavolini DAYTONA e tavolino CLUB.

HAERO sofa, WING LOUNGE CHAIR, DAYTONA coffee-tables and CLUB coffee table.



## Off-Shore sistema a parete\_wall system

design for living\_location 8

L'anta scorrevole in cristallo temperato trasparente o fumè, scorre su binari di alluminio anodizzato, creando composizioni libere, casuali, sempre più personalizzate. La retro illuminazione LED delle mensole in MDF, nelle finiture laccato lucido o opaco, nei colori bianco, tortora o crema, oltre ad un utilizzo pratico, valorizza la composizione e la rende parte creativa dell'arredamento.

The sliding door, crafted from clear or smoke-grey tempered glass, slides on anodized aluminium rails to create casual, unconfined compositions that can be customised according to your wishes.

The LED backlighting featured in the MDF shelving, which comes in white, dove-grey or cream with either a glossy or matt lacquer finish, is not only a practical addition but also adds value to the composition, making it a creative part of the furnishings.



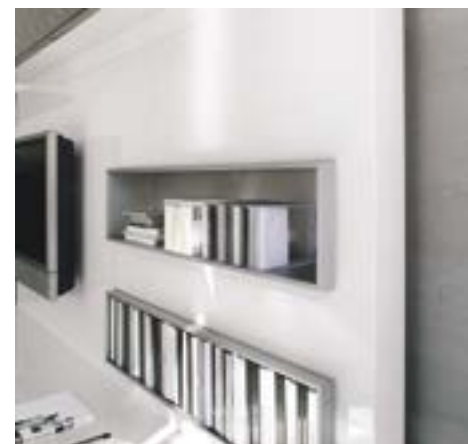

Il desiderio di elementi sempre più personalizzati ha portato designer e architetti a creare il sistema OFF-SHORE. La superficie laccata lucida aggiunge un ulteriore aspetto cromatico alla parete attrezzata, per personalizzare gli spazi abitativi, per contenere gli oggetti più cari. Porta DVD in alluminio per organizzare musica e film. La retro illuminazione LED delle mensole in MDF valorizza la

composizione e la rende parte creativa dell'arredamento. Supporto per TV al Plasma/LCD. Garantisce una posizione ottimale di visione con funzioni di inclinazione, rotazione e ripiegamento. Le mensole in MDF laccato lucido o opaco in bianco, tortora o crema, illuminate da LED diventano dettagli squisiti dove l'essenzialità lascia spazi aperti.

The desire to have elements with an ever-increasing potential for customisation led our designers and architects to create the OFF-SHORE system. The glossy lacquer surface adds another colour dimension to wall units and customises the living spaces that contain your most prized possessions. DVD holder in aluminium for organising music and films.

Plasma/LCD bracket that attaches to panel. Ensures perfect viewing experience thanks to tilt, swivel and reach functions. The white, dove-grey or cream MDF shelves, which feature a glossy or matt lacquer finish and LED backlighting, offer an exquisitely simple touch that can enhance space without cluttering it.

## Haero divano\_sofa

Dormeuse e divano HAERO,  
tavolino BENCH e tavolino UP.  
All'esterno WING LOUNGE CHAIR  
per esterno.

HAERO chaise-longue and sofa,  
BENCH coffee table and  
UP coffee table. WING LOUNGE  
CHAIR for outdoor.

design for living\_location 8



## Haero divano\_sofa

Haero la classica trapuntatura capitonné forma un disegno geometrico affascinante... concedetevi un momento di puro relax. Haero nella versione rilassante dormeuse. La base è in trafilato di alluminio spazzolato.

---

The classic quilting creates an enchanting geometric design. Allow yourself a moment of pure relax. Haero in the relaxed chaise-longue version. The base is made of brushed aluminium.



design for living\_location 8



## Haero divano\_sofa

design for living\_location 8

HAERO, ovvero la personificazione della comodità. La seduta è spaziosa, per un comfort ottimale, mentre schienale e bracciolo leggermente inclinati favoriscono la posizione corretta. La trapuntatura della seduta del divano HAERO è realizzata con dedizione sartoriale, come testimoniano le cuciture a vista, che parlano di una cura senza eguali nella lavorazione. In questa pagina: divani in pelle nera serviti dal tavolino centrale BENCH a due cassetti bianco lucido.

HAERO combines comfort with personality. The seat is spacious, for optimal comfort while the back and armrest are slightly inclined to allow an ergonomic seating. The HAERO sofa seat is embroidered and manufactured with a tailoring genius, as can be seen by simply looking at them. They are made with care in every detail. On this page: HAERO sofas in black leather with BENCH coffee table in glossy white with two drawers.



## Bench tavolini\_coffee tables

design for living\_location 8

Bench tavolini bassi  
molto capienti grazie ai due  
cassetti interni laterali.  
Ideali nel living: laccati o rovere.

---

Bench coffee tables made very  
spacious thanks to the two  
side internal drawers.  
Ideal in living spaces:  
lacquered or oak.





## Club poltroncina\_armchair

Poltroncina e tavolini dalle linee squadrate. Flessibili, adatti in ogni stanza della casa, capaci di aggiungere sempre un tocco di classe. Club poltroncina in pelle o tessuto con la base in acciaio cromato. Uno spazio relax completato dai tavolini Club. Studiata su una proporzione di spessori tra base e struttura. Club è ideale come poltroncina da conversazione sia per il living che per il contract.

---

Refined lounge chair and coffee tables, flexible solutions, ideal for any room, perfect to add a touch of class. Club lounge chair in leather or fabric with base in chrome-plated steel. A relaxing space completed with the Club coffee tables. Studied using a proportion of layers between the base and frame, the Club lounge chair is ideal for both domestic and contract settings.



## design for living\_location 8



## Club tavolini\_coffee tables

design for living\_location 8

I tavolini Club, nati per corredare i divani della collezione Alivar, diventano un particolare accattivante dell'area living se affiancati a due o più. Tavolino Club, base in acciaio cromato o laccato e piano in rovere, in MDF laccato o in marmo. Disponibile in tre diverse misure.

The Club side tables, specifically designed to match the Alivar lines, are captivating in the living area when placed in pairs or more. Club coffee table with chrome-plated or painted steel base and top in oak, in lacquered MDF or in marble. Available in three different sizes.



## XT tavolo\_table

XT tavolo con piano laccato lucido bianco e struttura in acciaio inox spazzolato. Il piano è disponibile nelle versioni rovere o in MDF laccato lucido o opaco.

---

XT table with glossy white lacquered top and legs in stainless steel. Top available also in oak or in glossy or matt lacquered MDF.

design for living\_location 8



## XT tavolo\_table

XT: il tavolo deve il nome al disegno creato dagli elementi della base, sulla quale poggia il piano. Elegantissimo nella propria estrema semplicità.

---

The XT table is named after the elements of its legs, on which lays the top. The elegant in its simplicity.



design for living\_location 8





Tutta la linea dei complementi giorno ALIVAR ha una forte connotazione minimalista. Edomadia si evidenzia nel design compatto ma, allo stesso tempo, leggero. La possibilità poi di scegliere tra una finitura opaca o, come in questo caso, lucida, permette di accentuarne o neutralizzarne l'effetto minimale. Edomadia essenza di linearità e di praticità. Credenza, caratterizzata dalla maniglia di linea non convenzionale.

---

The entire line of ALIVAR complements boasts distinctively minimalist lines. Edomadia highlighted by a compact and lightweight design.

The choice of matt or, as in this case, glossy finish either accentuates or neutralizes the minimalist effect. Edomadia, characterized by an unconventional handle. It is the essence of non-conventional linearity.



## Edomadia credenza\_sideboard

design for living\_location 8

Importante nella forma, elegante nei colori. Laccatura lucida nera e base verniciata con tre cassetti superiori e tre scomparti inferiori personalizzabili a richiesta con il portabottiglie. Base in acciaio cromato o verniciato.

The Edomadia sideboard has a notable form and elegant colours. Version in glossy black lacquered and painted steel base with three upper drawers and three lower compartments that can be personalized up on request with a bottle rack. Steel base, painted or chrome-plated.



## Kendo letto\_bed

Letto KENDO con comodino della collezione EDO. Pouf ASCOT e WING LOUNGE CHAIR.

KENDO bed with EDO bedside table. ASCOT ottoman and WING LOUNGE CHAIR.

design for living location 8

## Kendo letto\_bed

Kendo il letto con l'intramontabile imbottitura capitonné nella testata. Ideale da abbinare ai contenitori notte Edo. Il letto Kendo con telaio in acciaio e dettaglio della preziosa imbottitura Capitonné nella versione in pelle. Il comodino è della collezione Edo, in questa foto laccato lucido nero.

---

The bed featuring headboard with quilted padding. Perfect with Edo bedroom storage units. Kendo bed with steel frame and the fabulous Capitonné leather padding. The bedside table is from the Edo collection, in this version it has a glossy black finish.



design for living\_location 8





La collezione EDO propone settimanale, cassettone e comodino in legno laccato o rovere. A destra l'elegante comò laccato lucido nero.

The Edo collection: dresser, chest of drawers and bedside table in oak or lacquered. On the right: the elegant glossy black chest of drawers.



## Feng letto\_bed

Le sensuali forme del letto Feng prediligono il design essenziale dei contenitori notte FRAME. In questa pagina: letto FENG rivestito in tessuto e comodino EDO.

---

The sensual forms of the Feng bed go best with the classic design of the Frame bedroom storage units. In this page: FENG bed covered with fabric and EDO bedside table.

design for living\_location 8



## Frame complementi notte\_\_bedroom complements

Frame: una collezione di contenitori per la zona notte. Comò, settimanali e comodini, in essenza o laccati, con fianchi in alluminio spazzolato.

Frame collection cabinets for the night area: chest of drawers, dresser and bedside tables in oak or lacquered. Sides in brushed aluminium.



design for living\_location 8



## Pure Whiteness

---

Bianco, nero e le mille sfumature di grigio: il contrasto caratterizza l'arredo della casa ispirata alla purezza, nelle linee e nelle tonalità. Pochi e misurati elementi regalano una visione d'insieme dell'ambiente, sofisticata ed ampia, che si pone in armoniosa continuità con l'esterno.

White, black and all the greys in between: this contrast is characteristic of the furniture that is inspired by purity and linear tonality. Few selected elements which create a vision that is sophisticated and spacious, that is in continual harmony with the outside world.



## Ascot divano\_sofa

Volumi equilibrati  
e proporzioni  
generose.  
Il divano come concetto  
di rifugio accogliente  
dove poter leggere,  
conversare  
e rilassarsi.

---

Balanced  
sizes and generous  
proportions.  
The sofa as a cosy  
refuge where you  
can read, chat  
and relax.

pure whiteness\_location 9



Ascot divano\_sofa

pure whiteness\_location 9

Divani ASCOT, tavolini quadrati DAYTONA e tavolino CLUB. Sullo sfondo tavolo RADAR e sedie WING CHAIR.

ASCOT sofas, DAYTONA square coffee tables and CLUB coffee table. In the background RADAR table and WING CHAIRS.

**Ascot** divano\_sofa

Divano ASCOT, tavolini  
DAYTONA e CLUB, WING  
LOUNGE CHAIR e credenza  
EDOMADIA.

ASCOT sofa, DAYTONA and  
CLUB coffee tables, WING  
LOUNGE CHAIR and  
EDOMADIA sideboard.

pure whiteness\_location 9



## Denver credenza\_sideboard

Sfumature di grigio create  
dalla pietra Serena del piano  
e dalla laccatura delle ante.

---

Shades of grey made  
by the Serena stone  
and the lacquered doors.



## pure whiteness\_location 9







Madia DENVER, tavolo RADAR e sedie WING CHAIR.

DENVER sideboard, RADAR table and WING CHAIR.

## Radar tavolo\_table

Radar nella versione piano in marmo bianco Michelangelo, struttura in acciaio cromato e base in ghisa verniciata nera. Wing Chair in pelle bianca con struttura in alluminio lucido.

Radar with top in white Michelangelo marble, frame in chrome-plated steel and base in black painted cast iron. Wing Chair in white leather with frame in polished aluminium.



pure whiteness\_location 9



**Wing** poltroncina\_lounge chair

pure whiteness\_location 9

WING LOUNGE CHAIR  
poltroncina e pouf in corda  
intrecciata nella versione da  
esterno.

WING LOUNGE CHAIR and  
ottoman in woven rope for  
outdoor use.



## Wing poltroncina\_lounge chair

Collezione di sedie e poltroncine fluide e dinamiche. Attenta ricerca di elegante semplicità. Wing Lounge Chair con seduta e spalliera in corda intrecciata colore naturale, nera o bianca oppure rivestita in pelle o tessuto. Struttura in acciaio nelle finiture cromo o laccato.

Collection of fluid and dynamic chairs and lounge chairs. Expression of elegant simplicity. Wing lounge chair with seat and back in woven rope, either black, white or natural, or covered in leather or fabric. The frame is made of steel with choice of finishes: chrome-plated or lacquered.



pure whiteness\_location 9



## Wing sedia\_chair

Wing chair con seduta e spalliera in corda intrecciata colore naturale, nera o bianca oppure rivestita in pelle o tessuto. Struttura in alluminio lucido o verniciato.

Wing chair with seat and back in woven rope, either black, white or natural or covered in leather or fabric. The frame is in polished or painted aluminium.



pure whiteness\_location 9



pure whiteness\_location 9

Letto ECHO abbinato al settimanale e al comodino FJORD, poltroncina ATLANTA.

ECHO bed combined with the FJORD high chest of drawers and bedside table and ATLANTA armchair.



La zona notte dal sapore  
"new vintage"  
con Echo, letto con base in  
acciaio e testata rivestita in  
pelle. Fjord comodini  
abbinati con fianchi in  
essenza.

---

New vintage style for the  
bedroom with Echo, bed  
with steel base and  
headboard covered in  
leather, Fjord bedside  
tables with sides in wood.



## Fjord complementi notte\_bedroom complements

Fjord esalta al massimo la naturalezza del legno e la forte sensazione di tattilità.

---

Fjord spotlights the natural character of wood and its strong tactility.



## pure whiteness\_location 9





## Fjord complementi notte\_bedroom complements

Fjord settimanali con fianchi in essenza, top e cassetti rivestiti in cuoio. Più di un comodino, Fjord è quasi uno scrigno dove custodire gli oggetti più cari.

Fjord high chest of drawers with sides in wood, top and drawers covered in hide. More than a bedside table, the Fjord is like a jewellery box to keep your most dear possessions.



pure whiteness\_location 9



## Geometric living

---

La tecnologia trova il suo contesto ideale nelle linee e geometrie astratte delle pareti attrezzate, delle strutture multifunzionali, degli elementi autonomi. Il piacere si declina in sedie, divani e letti che coniugano rigore e morbidezza. La casa è un percorso evidenziato dal design.

Technology finds its ideal match in the abstract contours and shapes of the wall unit, the multifunctional structures and the self-standing units.

Available to enjoy in a range of chairs, sofas and beds which combine austerity and softness. Home is a journey in design.



## Frame sistema a parete\_wall system

Panche attrezzate, consolle e mensole luminose. Particolari di stile che non dimenticano dettagli tecnici come le canaline passacavi facilmente ispezionabili.

Storage units, bright consoles and shelves. Stylish elements that maintain useful technical details, such as easily accessible cable raceways.

geometric living\_location 10

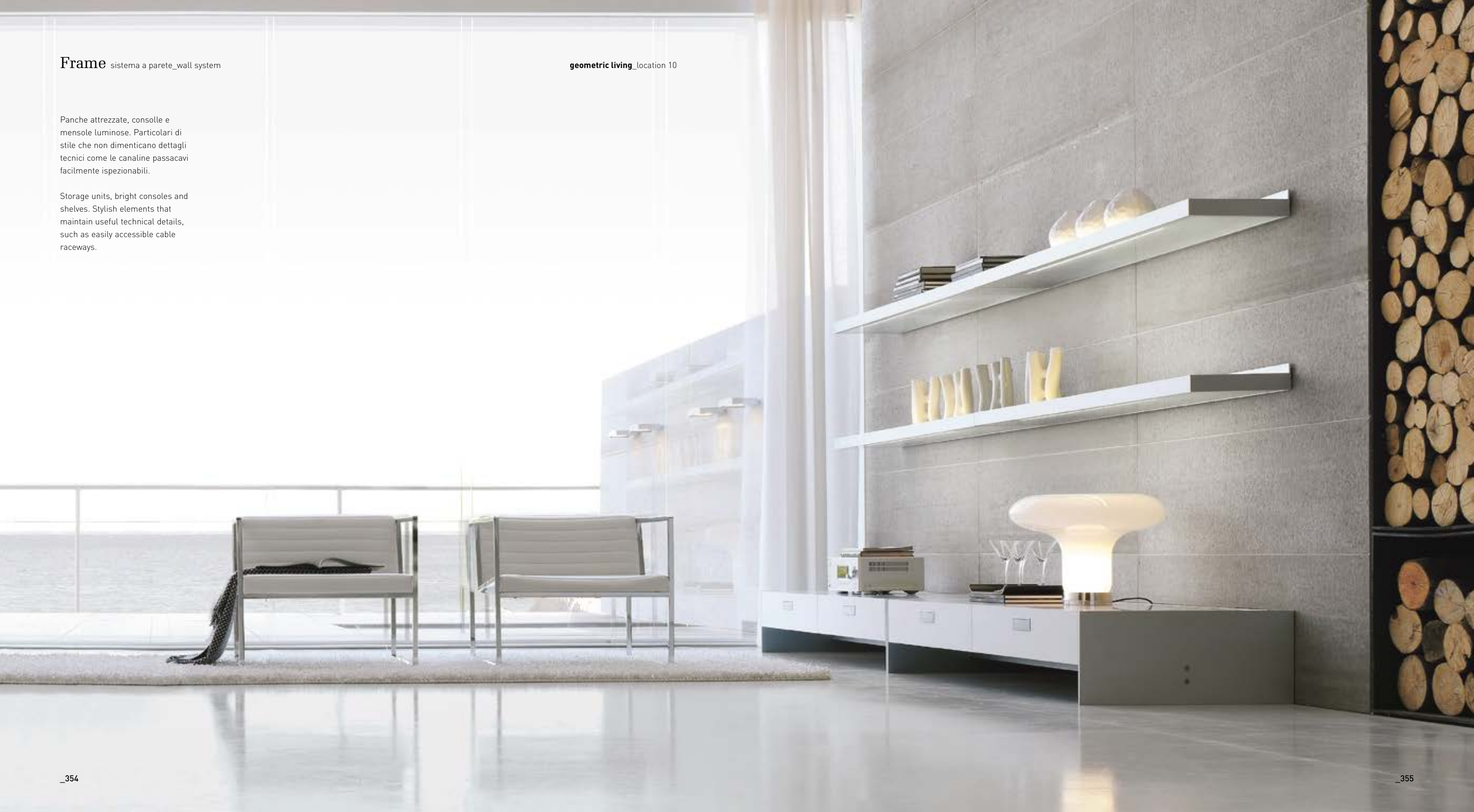



Frame collection è una collezione di complementi che coniuga in modo rigoroso design e tecnologia. Pezzi singoli fortemente caratterizzati e dotati di una personalità originale. Accuratamente studiata nella realizzazione dei dettagli e nell'utilizzo dei materiali, legno, vetro e alluminio, si fa interprete della modernità con le sue linee essenziali.

Frame is a collection of accessories which meticulously combine design with technology. Each single item is distinctive with its own original form. Details are carefully crafted using a combination of wood, glass and aluminium. Frame represents today's modern style with its clean lines and adaptability.



**Frame** sistema a parete\_wall system

Il porta Tv e Hi-fi è progettato per dare una sistemazione ordinata ed elegante ai dispositivi tecnologici di cui abitualmente ci circondiamo nel living. Cassetti interni in alluminio: dettagli preziosi e sapienti accostamenti.

The TV and hi-fi holder is designed to provide organized, elegant storage for the technological devices that generally surround us in our living space. Internal aluminium drawers: precious details and masterful combinations.

geometric living\_location 10



## Frame sistema a parete\_wall system

geometric living\_location 10

Tecnologia e scenografia: particolari determinanti nella personalità di questa collezione, originale e fortemente definita. Frontali laccati per addolcire l'impatto della struttura in alluminio, fanno diventare questi mobili contenitori, i piani d'appoggio naturali per i nostri oggetti più cari.

Technology and design: key details in the personality of this original, strongly defined collection. Lacquered front panels, which soften the impact of the aluminium frame, turn these cabinets into the natural homes of our most treasured possessions.



## Dublin divano\_sofa

Divani DUBLIN in pelle,  
poltroncine WING LOUNGE  
CHAIR e tavolini HARPA.

DUBLIN sofas in leather,  
WING LOUNGE CHAIR and  
HARPA side and coffee tables.

geometric living\_location 10



## Dublin divano\_sofa

geometric living\_location 10

Dublin: una sintesi  
tra equilibrio di linee e volumi.  
Imbottito di prima qualità,  
ideale per un arredamento  
di classe e di sicuro effetto.

Dublin: the perfect blend of  
contours and proportions. Top  
quality padding, perfect for  
sophisticated, dark-effect  
furnishings.





## Atlanta poltroncina\_lounge chair

Atlanta: estremamente elegante  
la lavorazione  
del rivestimento in pelle.  
Ideale per il living, l'attesa  
e la reception.

---

The Atlanta lounge chair is  
extremely elegant in its  
leather padded upholstery.  
Atlanta products are ideal and  
suitable for both domestic and  
contract settings.

geometric living\_location 10



Atlanta poltroncina\_lounge chair | Up tavolino\_coffee table

Atlanta poltroncina con o senza braccioli in acciaio si abbina ai tavolini Up o coordinata al pouf.

Atlanta lounge chair with or without armrests combined with Atlanta ottoman and Up coffee table.



geometric living\_location 10



Up tavolini\_coffee tables

Utili e semplici accessori per i salotti Alivar, i tavolini Up con piano disponibile in rovere, in MDF laccato o in marmo.

UP coffee tables, useful and simple accessories for Alivar sofas. Top available in oak, in lacquered MDF or in marble.



geometric living\_location 10



## Folio porta tv\_tv unit

Folio elemento porta TV: pannello in rovere o laccato. Colonnine laterali porta CD/DVD e mensole per videoregistratore/decoder.  
Luce fluorescente superiore di servizio.

Folio Tv unit: oak or lacquered panel, side racks for storing CDS/DVS and shelves for VCRS/recorders. Fluorescent light.



## geometric living\_location 10



**HF** porta tv\_tv unit

Soluzione innovativa e versatile per il living, il porta Tv e Hi-Fi è progettato attorno alle esigenze della casa moderna, dove i dispositivi tecnologici rivestono un ruolo di primo piano. Luce di cortesia e vano per dvd o decoder.

The TV and Hi-Fi unit is innovative and versatile. It was designed to meet the needs of modern homes, where electronic devices take a first hand role. Fluorescent light and aluminium shelf for DVD player or decoder.



**geometric living\_location 10**



## Plaza letto\_bed

Un segno rigoroso caratterizzato da tratti squadrati, in contrasto con la morbida testata. Letto Plaza attrezzabile con comodini. Testata attrezzabile con rivestimento in pelle o tessuto.

Austere square design in contrast with the soft headboard.  
A bed that can be combined with bedside tables. Padded headboard with leather or fabric covers.



geometric living\_location 10



## Finiture & Colori / Colours and finishing

### laccature per legno\*\* \_ WOOD LACQUERS\*\*

RAL 9016 bianco lucido o opaco_ glossy or matt white	04.84 crema lucido o opaco_ glossy or matt cream	15.65 sabbia lucido o opaco_ glossy or matt sand	05.70 tortora lucido o opaco_ glossy or matt dove brown
10.60 corda lucido o opaco_ glossy or matt rope	05.60 grigio lucido o opaco_ glossy or matt grey	D 075.60.20 kaki lucido o opaco_ glossy or matt kaki	D 070.60.30 deserto lucido o opaco_ desert or matt rope
RAL 7006 castoro lucido o opaco_ glossy or matt beaver	RAL D 060.40.05 fango lucido o opaco_ glossy or matt mud	RAL D 060.30.10 cioccolato lucido o opaco_ glossy or matt chocolate	RAL D 050.70.10 cipria lucido o opaco_ glossy or matt powder
D 050.60.20 rosybrown lucido o opaco_ glossy or matt rosybrown	40.20 rosso scuro lucido o opaco_ glossy or matt dark red	RAL 3007 rosso amaranto lucido o opaco_ glossy or matt amaranth red	50.40 aragosta lucido o opaco_ glossy or matt lobster
RAL D 260.40.10 lavanda lucido o opaco_ glossy or matt lavender	RAL D 320.30.05 melanzana lucido o opaco_ glossy or matt eggplant	RAL D 080.60.30 senape lucido o opaco_ glossy or matt mustard	20.50 verde lucido o opaco_ glossy or matt green
RAL D 100.50.10 salvia lucido o opaco_ glossy or matt sage	RAL D 100.60.05 grigio lucido o opaco_ glossy or matt grey	RAL 9005 nero lucido o opaco_ glossy or matt black	laminato liquido bianco* _ white liquid laminate*

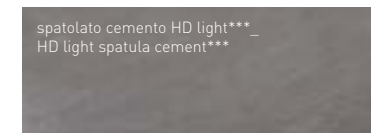

spatolato cemento HD light\*\*\* \_  
HD light spatula cement\*\*\*

\* Il "laminato liquido" è una vernice con caratteristiche particolari di resistenza al graffio e idrorepellente / Il prodotto è stato studiato e formulato con l'utilizzo di resine particolari e microsferi omogenee selezionate di alta durezza.  
"Liquid laminate paint" is a special paint with scratch-proof characteristics. The product was conceived and formulated with the use of special resins and very hard selected, homogeneous microspheres.

\*\* Colori disponibili anche per alcune strutture metalliche (su richiesta)  
Colours available also for some aluminium frames (on demand).

\*\*\* Quattro strati di cemento spatolato a mano HD light  
Four layers of spatula hand-worked concrete.

### essenze \_WOOD

rovere sbiancato_ bleached oak	rovere tinto wengé_ wengé-stained oak	rovere grigio_grey oak	rovere nero_black oak
rovere "Cappuccino" _ "Cappuccino" oak	rovere termotrattato_ heat-treated oak	noce "Nazionale" _ italian walnut	palissandro_ rosewood

## marmi e pietre \_MARBLES AND STONES



marmo Marquina nero\_  
black "Marquina" marble

marmo Michelangelo bianco\_  
white "Michelangelo" marble

marmo bianco "Calacatta oro" \_  
"Gold Calacatta" white marble

marmo Emperador\_  
"emperador" marble

pietra Serena\_  
"Serena" stone

pietra acrilica bianca\* \_  
white acrylic stone\*

\* Pietra acrilica \_acrylic stone. Materiale composto di alto pregio, duraturo e resistente, non assorbente e non poroso. Ecologico, assolutamente impermeabile, non cambia colore nel tempo. È igienico perchè non poroso.  
Acrylic stone of high quality, durability and resistance, as well as non absorbent and non porous. Ecological and absolutely water proof. Colour doesn't change over time. Hygienic because it's not porous.

## laccature e finiture per metallo \_STEEL LACQUERS AND FINISHES

RAL 9016 bianco _ white	RAL 1013 crema_cream	RAL 7006 castoro_beaver	RAL 8019 testa di moro opaco_ matt dark brown	RAL 3003 rosso rubino_ ruby red	RAL 3004 rosso scuro_ dark red
alluminio cromo_ alu-chrome	alluminio gofrato_ embossed aluminium	3100 oro-bronzato_ golden bronze	320 nero perlato_ black pearl	4820 ruggine perlato_ rusty pearl	RAL 9005 nero_black

### FINITURE PER T-GONG \_ STEEL FINISHES FOR T-GONG

laccatura Peltrox _ Peltrox lacquer	bronzo_ bronze	champagne_ champagne_	Finitura Peltrox_ Peltrox finish	Finitura Bronzo_ Bronze finish	Finitura Rame_ copper finish
--	-------------------	--------------------------	-------------------------------------	-----------------------------------	---------------------------------

# HOME PROJECT

## Technical sheets

---

Dalla contestualizzazione alla concretezza delle caratteristiche tecniche: ogni proposta Home Project sa farvi sognare per il design elegante e sa convincervi per la qualità e la forte dose di innovazione.

From different proposals to technical details for practical needs: every Home Project proposal meets your needs with elegant design, high quality materials and innovation.





# Frame Collection

systemi a parete / wall units

Pagina\_Page 354

## Mensole / Shelves

Mensola con bordo in alluminio verniciato. Piano in cristallo satinato temperato spessore 5 mm, disponibile con luce fluorescente interna.  
Shelf. Edging frame in painted aluminium. Satin tempered glass top, 5 mm thick available with inside fluorescent light.

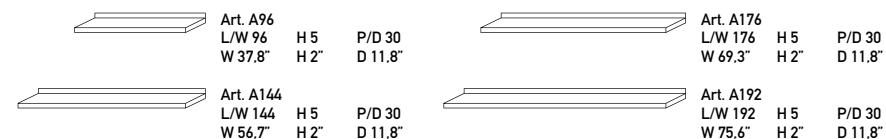

## Mobili base / Base units

Mobile base con fianchi in alluminio verniciato e piano in cristallo satinato temperato spessore 6 mm.  
Base unit. Sides in painted aluminium. Satin tempered glass top, 6 mm thick.



## Mobili base con cassetti / Base units with drawers

Mobile base con canalina passacavi e fianchi in alluminio verniciato. Piano e cassetti in rovere o MDF laccato.  
Base unit with painted aluminium sides with cables raceway. Top and drawers in oak or in lacquered MDF.



## Mobili base con cassetti / Base units with drawers

Mobile base con fianchi in alluminio verniciato. Piano e cassetti in rovere o MDF laccato.  
Base unit with painted aluminium sides. Top and drawers in oak or in lacquered MDF.



## Consolle pensili / Hanging consoles

Consolle pensile con fianchi e piano inferiore in alluminio verniciato. Piano superiore e cassetti disponibili in rovere o MDF laccato.  
Hanging console with painted aluminium sides and lower top. Upper top and drawers in oak or in lacquered MDF.

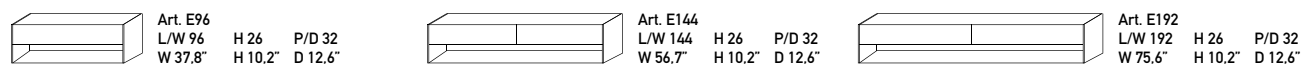

## Vetrine pensili / Hanging glass cupboards

Vetrina pensile con interno in MDF laccato. Fianchi in alluminio verniciato. Top e anta a ribalta in cristallo.  
Hanging glass cupboard in lacquered MDF. Painted aluminium sides. Top and flapping door in glass.



## Esempi di composizioni / Examples of combinations

### Composizione\_Combination "A"

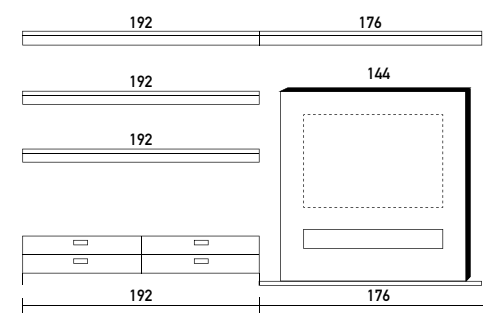

### Composizione / Combination "G"

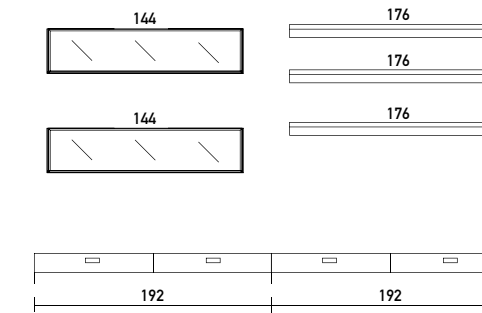

# Folio

elemento porta TV/HI-FI / television/HI-FI unit

Pagina\_Page 372

Elemento porta TV/HI-FI con fori passacavi. Pannello in MDF laccato lucido, opaco o in rovere.  
Colonnine laterali porta CD/DVD in alluminio.  
Mobiletto per videoregistratore/decoder.  
Luce fluorescente superiore di servizio.

Television / HI-FI unit with an oak veneer or in glossy or matt lacquered MDF. Arranged with cables raceway.  
Aluminium CD/DVD rack on both sides.  
Shelves for DVD/Video recorder. Fluorescent light.

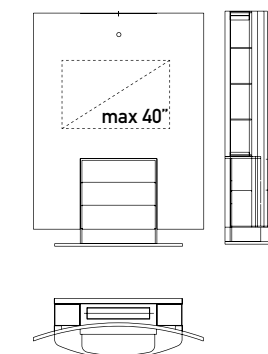

# HF1 / HF2 / HF3

elemento porta TV/HI-FI / television/HI-FI unit

Pagina\_Page 374

Elemento porta TV/HI-FI in rovere o MDF laccato lucido o opaco con fori passacavi. Base in alluminio verniciato con piedini regolabile. Colonnine laterali porta DVD in alluminio. Mensola in alluminio per videoregistratore e decoder. Interruttore centrale per accensione. Luce fluorescente superiore di servizio.

Television/HI-FI unit with an oak veneer or in glossy or matt lacquered MDF. Arranged with cables raceway. Basement in painted aluminium plate with adjustable feet. Aluminium DVD rack on both sides. Shelf in aluminium for DVD/Video recorder. Power switch. Fluorescent light.

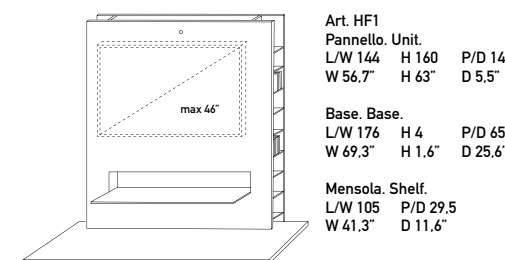

Elemento porta TV/HI-FI con basamento ovale in acciaio laccato alluminio con piedini regolabili.  
Television/HI-FI unit with aluminium painted steel basement, oval shape with adjustable feet.

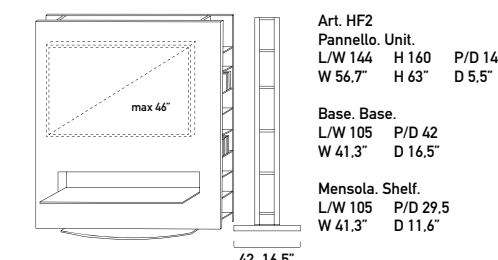

Elemento porta TV/HI-FI con fori posteriori per fissaggio a parete.  
Basamento semiovale in acciaio laccato alluminio.

Television/HI-FI unit with aluminium painted steel basement. Arranged with holes on the back panel for wall-fixing.

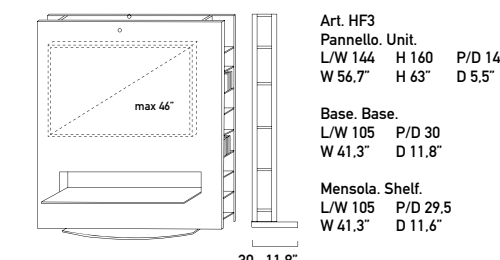

# Wavy

libreria / bookcase

Pagina\_Page 244

Libreria in pietra acrilica bianca. Materiale composito di alto pregio, duraturo e resistente, non assorbente e non poroso. Ecologico, assolutamente impermeabile, non cambia colore nel tempo, è igienico perché non poroso. Pannello posteriore in melaminico bianco.

Bookcase in white acrylic stone. Materials used are of high quality, durability and resistance, as well as non absorbent and non porous. Ecological, absolutely water proof, the colour doesn't change over time, hygienic because it's not porous. Back panel in white melamine.



### WAVY esempi di composizioni / examples of combinations

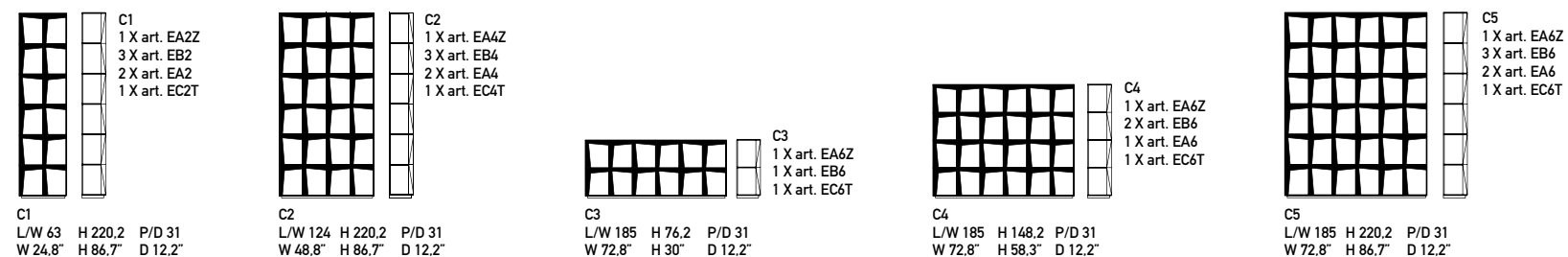

# Wavy Up

libreria / bookcase

Pagina\_Page 250

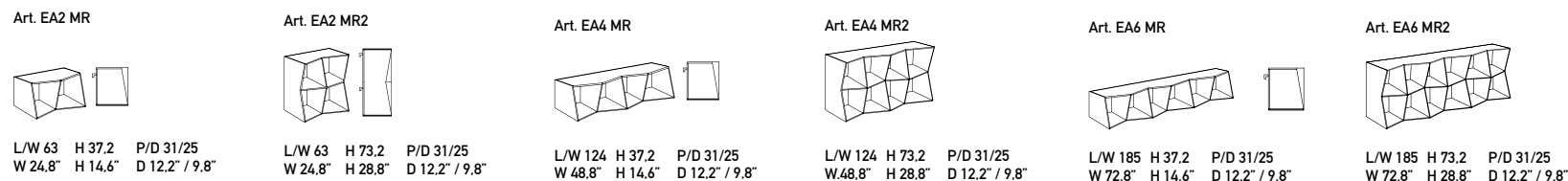

### WAVY UP esempi di composizioni / examples of combinations

# Shanghai

libreria / bookcase

Pagina\_Page 220

**Art LSH1** Libreria. Struttura esterna in rovere o in legno laccato opaco. Ripiani interni in MDF rivestiti in cemento HD Light Cement colore "French grey". Finiture struttura esterna: rovere termotrattato / rovere verniciato / laccato opaco Ral 10.60 / laccato opaco bianco Ral 9016.

Bookcase. External frame in oak or in matt lacquered wood. Inner shelves in MDF covered in HD Light Cement "French grey" colour. External frame finishing: Heat-treated oak / varnished oak / Ral 10.60 matt lacquer / Ral 9016 matt white lacquer.

**Art LSH2** Libreria. Struttura esterna in rovere o in MDF laccato opaco. Ripiani interni in MDF sistema DUXILON laccato opaco. Finiture struttura esterna: rovere termotrattato / rovere verniciato / laccato opaco Ral 10.60/ laccato opaco bianco Ral 9016. Colori ripiani interni: laccato opaco corda 10.60 / laccato opaco grigio Ral D 100.60.05 / laccato opaco bianco Ral 9016.

Bookcase. External frame in oak or in matt lacquered MDF. Inner shelves in matt lacquered MDF with DUXILON process. External frame finishing: Heat-treated oak / varnished oak / Ral 10.60 matt lacquer / Ral 9016 matt white lacquer. Inner shelves colours: 10.60 matt rope lacquer / Ral D 100.60.05 matt grey lacquer / Ral 9016 matt white lacquer.

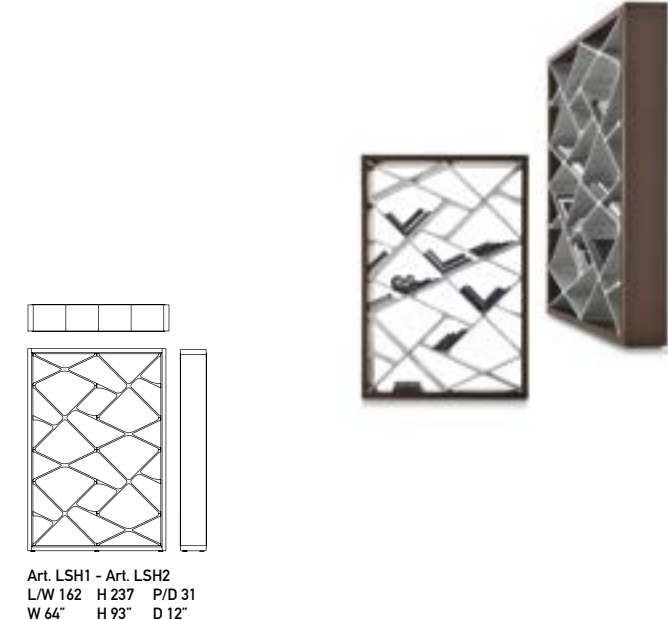

Art. LSH1 - Art. LSH2  
L/W 162 H 237 P/D 31  
W 64" H 93" D 12"

# Dorothea

libreria / bookcase

Pagina\_Page 172

Libreria in rovere verniciato, con cassetto. Ripiani in cuoio. Ante in cristallo temperato. Illuminazione LED.

Bookcase in stained oak with drawer. Hide shelves. Tempered glass door. LED lighting.

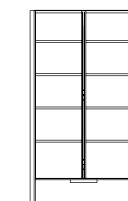

Art. CDT  
L/W 122 H 220 P/D 41  
W 48" H 86.6" D 16.1"



# Dorothea XL

libreria / bookcase

Pagina\_Page 170

Libreria in rovere verniciato con cassetti. Ripiani in cuoio. Ante in cristallo temperato. Illuminazione LED.

Bookcase in stained oak with drawers. Hide shelves. Tempered glass door. LED lighting.

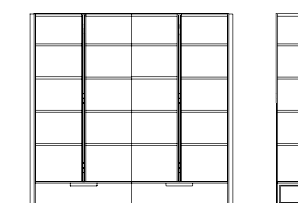

Art. CDTXL  
L/W 228 H 220 P/D 41  
W 89.8" H 86.6" D 16.1"



# Diesys

libreria / bookcase

Pagina\_Page 30 - 92

Libreria. Profilo in acciaio spazzolato con protezione trasparente o in acciaio inox finitura "Ambra Satin". Ripiani in Noce "Nazionale", rovere termotrattato o palissandro. Accessori in legno e cuoio.

Bookcase. Brushed steel profile with transparent protection or in stainless steel "Satin Amber" finish. Italian walnut, heat-treated oak or rosewood shelves. Wooden and hide accessories.



profilo finitura ripiano  
shelf finishing edge

ART. LDIEPF  
L/W 1 P/D 26  
W 0.4" D 10.2"

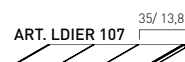

ripiano\_shelf

ART. LDIER 107  
L/W 107.8 H 3 P/D 30  
W 42.4" H 1.2" D 11.8"

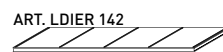

ART. LDIER 142  
L/W 142.2 H 3 P/D 30  
W 56" H 1.2" D 11.8"

spalletta  
side element

ART. LDIES 35  
L/W 1.6 H 35 P/D 26  
W 0.6" H 13.8" D 10.2"

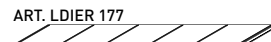

ART. LDIER 177  
L/W 177.8 H 3 P/D 30  
W 70" H 1.2" D 11.8"

ART. LDIES 16  
L/W 1.6 H 16 P/D 26  
W 0.6" H 6.3" D 10.2"



ART. LDIER 212  
L/W 212.6 H 3 P/D 30  
W 83.7" H 1.2" D 11.8"

accessori\_accessories

scatola  
box

ART. LDIESC 15  
L/W 32.7 H 15.9 P/D 26  
W 12.9" H 6.3" D 10.2"



ART. LDIER 247  
L/W 247.4 H 3 P/D 30  
W 97.4" H 1.2" D 11.8"

scatola  
box

ART. LDIESC 34  
L/W 32.7 H 34.9 P/D 26  
W 12.9" H 13.7" D 10.2"

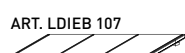

basamento\_base

ART. LDIEB 107  
L/W 107.8 H 6 P/D 30  
W 42.4" H 2.4" D 11.8"

scaffale  
rack

ART. LDIES 32  
L/W 32.7 H 34.9 P/D 26  
W 12.9" H 13.7" D 10.2"

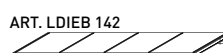

ART. LDIEB 142  
L/W 142.2 H 6 P/D 30  
W 56" H 2.4" D 11.8"

cassettiera  
drawer unit

ART. LDIEC 67  
L/W 67.7 H 34.9 P/D 26  
W 26.6" H 13.7" D 10.2"

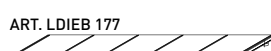

ART. LDIEB 177  
L/W 177.8 H 6 P/D 30  
W 70" H 2.4" D 11.8"

ESEMPI DI COMPOSIZIONE  
example of composition

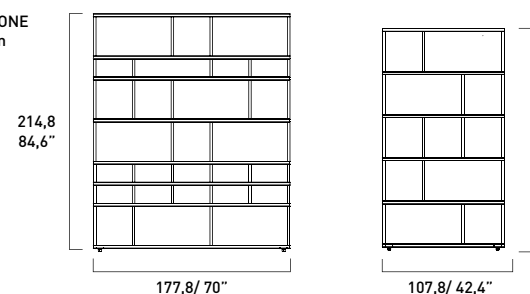

# Tratto

contenitori / cabinets

Pagina\_Page 150

Sistema di mobili contenitori per l'area notte e living. Elementi a giorno, con cassetti o con ante a battente, che si possono modulare tra loro per comporre e realizzare la soluzione su misura. Disponibile nelle finiture rovere, Noce "Nazionale" o in MDF laccato con ante e cassetti in legno laccato o rivestiti in cuoio.



A new system of containers for the bedroom or living room. TRATTO is composed of various cabinets, with drawers or shutter doors that can be combined to create tailor-made solutions. Available in oak, Italian walnut or in lacquered MDF with doors and drawers in painted wood or covered in hide.

Mobile con anta battente  
Cabinet with door.

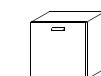

Art. TTM 62B DX/SX  
L/W 62 H 64 P/D 42.8  
W 24.4" H 25.2" D 16.8"

Mobile con cassetti.  
Cabinet with drawers.

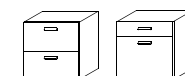

Art. TTM 62 C2 / A - B  
L/W 62 H 64 P/D 42.8  
W 24.4" H 25.2" D 16.8"

Mobile con cassetti.  
Cabinet with drawers.

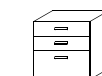

Art. TTM 62 C3  
L/W 62 H 64 P/D 42.8  
W 24.4" H 25.2" D 16.8"

Mobile con cassellario.  
Filing cabinet.

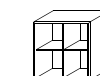

Art. TTM 62A  
L/W 62 H 64 P/D 42.8  
W 24.4" H 25.2" D 16.8"

Mobile con anta in cristallo  
Cabinet with glass door.

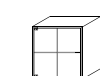

Art. TTM 62V DX/SX  
L/W 62 H 64 P/D 42.8  
W 24.4" H 25.2" D 16.8"

Spalle di finitura.  
Side panel.

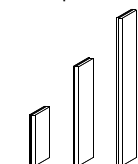

Art. TTSF 66  
L/W 7 H 66.2 P/D 46  
W 2.7" H 26.1" D 18.1"

Art. TTSF 130  
L/W 7 H 130.2 P/D 46  
W 2.7" H 51.3" D 18.1"

Art. TTSF 194  
L/W 7 H 194.2 P/D 46  
W 2.7" H 76.5" D 18.1"

Basamento.  
Base.



Art. TTB 131  
L/W 131 H 4.5 P/D 46  
W 51.6" H 1.8" D 18.1"

Art. TTB 193  
L/W 193 H 4.5 P/D 46  
W 76" H 1.8" D 18.1"

Art. TTB 255  
L/W 255 H 4.5 P/D 46  
W 100.4" H 1.8" D 18.1"

Art. TTB 317  
L/W 317 H 4.5 P/D 46  
W 124.8" H 1.8" D 18.1"

Top.  
Top.

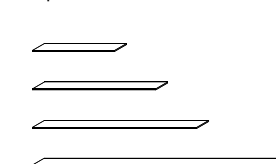

Art. TTT 124  
L/W 124 H 1.5 P/D 42.8  
W 48.8" H 0.6" D 16.8"

Art. TTT 186  
L/W 186 H 1.5 P/D 42.8  
W 73.2" H 0.6" D 16.8"

Art. TTT 248  
L/W 248 H 1.5 P/D 42.8  
W 97.6" H 0.6" D 16.8"

Art. TTT 310  
L/W 310 H 1.5 P/D 42.8  
W 122" H 0.6" D 16.8"

ESEMPI DI COMPOSIZIONE  
example of composition

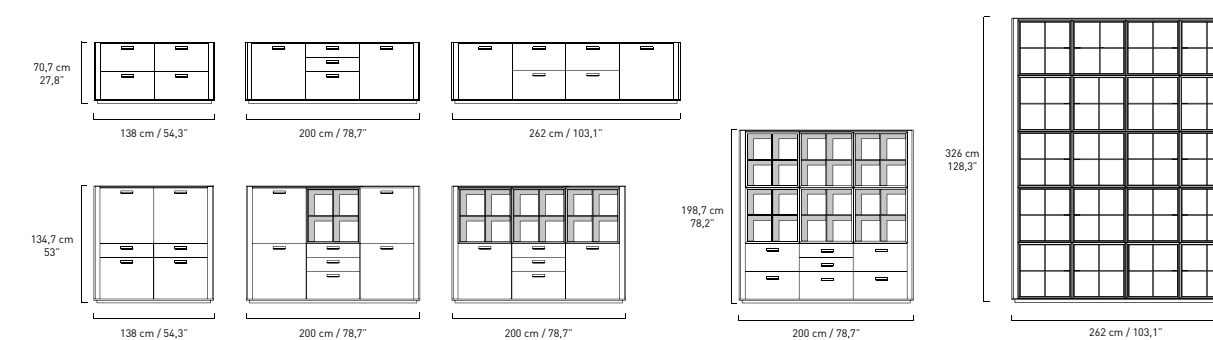

# Tratto bar

credenza / sideboard

Pagina\_Page 46

Credenza. Struttura in noce "Nazionale" o rovere termotrattato. Ante e top in cuoio. Vano interno attrezzato con specchio, ripiani, 3 cassetti e 2 cassettini in cuoio. Luce interna su richiesta.



Sideboard. Frame in Italian walnut or in heat-treated oak. Doors and top in hide. Inside compartment equipped with mirror, shelves, 3 drawers and 2 little drawers in hide. Led lighting on demand.

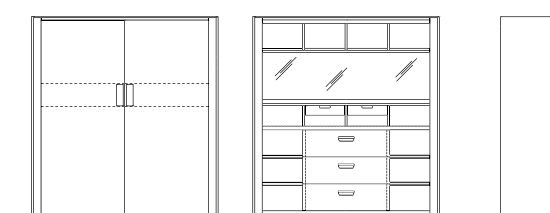

Art. MTT138  
L/W 138.2 H 150.7 P/D 46  
W 54.4" H 59.3" D 18.1"

# Swing

divano / sofa

Pagina\_Page 12

Poltrona e divano. Base in massello di rovere verniciato o noce con telaio interno in acciaio. Struttura in legno rivestita in gomma poliuretanica e trapunta in piuma sterilizzata. Cuscini in gomma poliuretanica e trapunta in piuma sterilizzata con uno strato di schiuma Memory. Rivestimento in tessuto o pelle.

Armchair and sofa. Base in painted massive oak or in walnut with inner steel frame. Wooden frame with polyurethane foam upholstery and sterilized feathers quilt. Cushions in polyurethane foam and sterilized feathers quilt with a layer of Memory foam. Fabric or leather covers.

### Poltrona. / Armchair.



Art. DSW100  
L/W 100 H 65 P/D 100  
W 39.4" H 25.6" D 39.4"

### Divano. / Sofa.

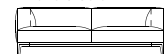

Art. DSW200  
L/W 200 H 65 P/D 100  
W 78.7" H 25.6" D 39.4"

Art. DSW220  
L/W 220 H 65 P/D 100  
W 86.6" H 25.6" D 39.4"

Art. DSW240  
L/W 240 H 65 P/D 100  
W 94.5" H 25.6" D 39.4"

### Divano. / Sofa.



Art. DSW260  
L/W 260 H 65 P/D 100  
W 102.4" H 25.6" D 39.4"

Art. DSW280  
L/W 280 H 65 P/D 100  
W 110.2" H 25.6" D 39.4"

### Elemento terminale. / Ending element.



Art. DSWT100 DX/SX  
L/W 100 H 65 P/D 100  
W 39.4" H 25.6" D 39.4"

### Elemento terminale. / Ending element.



Art. DSWT180 DX/SX  
L/W 180 H 65 P/D 100  
W 70.9" H 25.6" D 39.4"

Art. DSWT220 DX/SX  
L/W 220 H 65 P/D 100  
W 86.6" H 25.6" D 39.4"

Art. DSWT240 DX/SX  
L/W 240 H 65 P/D 100  
W 94.5" H 25.6" D 39.4"

### Elemento terminale. / Ending element.

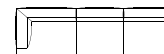

Art. DSWT260 DX/SX  
L/W 260 H 65 P/D 100  
W 102.4" H 25.6" D 39.4"

Art. DSWT280 DX/SX  
L/W 280 H 65 P/D 100  
W 110.2" H 25.6" D 39.4"

### Dormeuse. / Sofa.

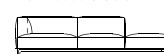

Art. DSWD260 DX/SX  
L/W 260 H 65 P/D 100  
W 102.4" H 25.6" D 39.4"

### Dormeuse con pouf. / Sofa with ottoman

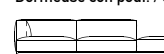

Art. DSWD280 DX/SX  
L/W 280 H 65 P/D 100  
W 110.2" H 25.6" D 39.4"

### Dormeuse predisposta per tavolino. / Sofa arranged for side table.

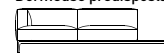

Art. DSWD260T DX/SX  
L/W 260 H 65 P/D 100  
W 102.4" H 25.6" D 39.4"

Art. DSWD280T DX/SX  
L/W 280 H 65 P/D 100  
W 110.2" H 25.6" D 39.4"

### Piano. / Top.



Art. TSW80  
L/W 80 P/D 100  
W 31.5" D 39.4"

Art. TSW100  
L/W 100 P/D 100  
W 39.4" D 39.4"

### Elemento angolare. / Corner element.

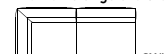

Art. DSWA200 DX/SX  
L/W 200 H 65 P/D 100  
W 78.7" H 25.6" D 39.4"

Art. DSWA220 DX/SX  
L/W 220 H 65 P/D 100  
W 86.6" H 25.6" D 39.4"

### Elemento angolare. / Corner element.

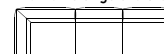

Art. DSWA260 DX/SX  
L/W 260 H 65 P/D 100  
W 102.4" H 25.6" D 39.4"

Art. DSWA280 DX/SX  
L/W 280 H 65 P/D 100  
W 110.2" H 25.6" D 39.4"

### Elemento angolare con pouf. / Corner element with ottoman.

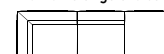

Art. DSWA260P DX/SX  
L/W 260 H 65 P/D 100  
W 102.4" H 25.6" D 39.4"

Art. DSWA280P DX/SX  
L/W 280 H 65 P/D 100  
W 110.2" H 25.6" D 39.4"

### Elemento angolare predisposto per tavolino. / Corner element arranged for side table.

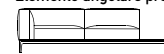

Art. DSWA260T DX/SX  
L/W 260 H 65 P/D 100  
W 102.4" H 25.6" D 39.4"

Art. DSWA280T DX/SX  
L/W 280 H 65 P/D 100  
W 110.2" H 25.6" D 39.4"

### Piano. / Top.



Art. TSW80  
L/W 80 P/D 100  
W 31.5" D 39.4"

Art. TSW100  
L/W 100 P/D 100  
W 39.4" D 39.4"

### Elemento centrale. / Central element.

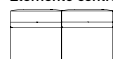

Art. DSWC200  
L/W 200 H 65 P/D 100  
W 78.7" H 25.6" D 39.4"

### Panca. / Bench.

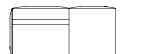

Art. DSWP180 DX/SX  
L/W 180 H 65 P/D 100  
W 70.9" H 25.6" D 39.4"

### Panca. / Bench.



Art. DSWP200 DX/SX  
L/W 200 H 65 P/D 100  
W 78.7" H 25.6" D 39.4"

Art. DSWP220 DX/SX  
L/W 220 H 65 P/D 100  
W 86.6" H 25.6" D 39.4"

### Panca. / Bench.



Art. DSWP240 DX/SX  
L/W 240 H 65 P/D 100  
W 94.5" H 25.6" D 39.4"

### Elemento predisposto per tavolino. / Element arranged for side table.



Art. DSW180T DX/SX  
L/W 180 H 65 P/D 100  
W 70.9" H 25.6" D 39.4"

Art. DSW200T DX/SX  
L/W 200 H 65 P/D 100  
W 78.7" H 25.6" D 39.4"

Art. DSW220T DX/SX  
L/W 220 H 65 P/D 100  
W 86.6" H 25.6" D 39.4"

### Elemento predisposto per tavolino. / Element arranged for side table.

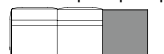

Art. DSW240T DX/SX  
L/W 240 H 65 P/D 100  
W 94.5" H 25.6" D 39.4"

Art. DSW260T DX/SX  
L/W 260 H 65 P/D 100  
W 102.4" H 25.6" D 39.4"

Art. DSW280T DX/SX  
L/W 280 H 65 P/D 100  
W 110.2" H 25.6" D 39.4"

### Piano. / Top.

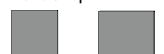

Art. TSW80  
L/W 80 P/D 100  
W 31.5" D 39.4"

Art. TSW100  
L/W 100 P/D 100  
W 39.4" D 39.4"

### Chaise longue. / Chaise longue.



Art. DSWD100 DX/SX  
L/W 100 H 65 P/D 180  
W 39.4" H 25.6" D 70.9"

### Tavolino. / Coffee table.

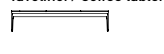

Art. TSWQ100  
L/W 100 H 19 P/D 100  
W 39.4" H 7.5" D 39.4"

### Pouf. / Ottoman.



Art. PSW100  
L/W 100 H 40 P/D 100  
W 39.4" H 15.7" D 39.4"

### Tavolino di servizio. / Service table.

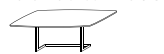

Art. TSW70  
L/W 70 H 39 P/D 35  
W 27.5" H 15.3" D 13.8"

### Cuscino. / Cushion.



Art. CSW45  
L/W 45x45  
W 17.7"x17.7"

Art. CSW58  
L/W 58x58  
W 22.8"x22.8"

# Land

divano / sofa

Pagina\_Page 74

Divano. Struttura in legno rivestita in gomma poliuretanica e trapunta in piuma sterilizzata. Cuscini in gomma poliuretanica e trapunta in piuma sterilizzata con uno strato di schiuma Memory. Rivestimento in pelle o tessuto. Piedi in acciaio cromato, verniciato, inox finitura Peltrox o nickel nero. Si consigliano 3 cuscini. Cuciture "punto cavallo" tono su tono; cuciture a contrasto su richiesta.

Sofa. Wooden frame with polyurethane foam upholstery and sterilized feathers quilt. Cushions in polyurethane foam and sterilized feathers quilt with a layer of Memory foam. Leather or fabric cover. Feet in chrome-plated or painted steel, in stainless steel, Peltrox finish or black nickel. We suggest 3 cushions. "Horse seam" stitching in the same colour tone; contrasting thread by request.

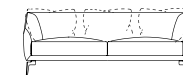

Art. DLN197  
L/W 197 H 67 P/D 97  
W 77.6" H 26.4" D 38.2"

Art. DLN222  
L/W 222 H 67 P/D 97  
W 87.4" H 26.4" D 38.2"



Art. DLN247  
L/W 247 H 67 P/D 97  
W 97.2" H 26.4" D 38.2"

Si consigliano 4 cuscini.

We suggest 4 cushions.

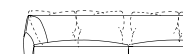

Art. DLN247  
L/W 247 H 67 P/D 97  
W 97.2" H 26.4" D 38.2"

### Elemento terminale destro o sinistro.

Left or right ending element.

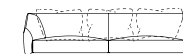

Art. DLNT187 DX/SX  
L/W 187 H 67 P/D 97  
W 73.6" H 26.4" D 38.2"

Art. DLNT211 DX/SX  
L/W 211 H 67 P/D 97  
W 83.1" H 26.4" D 38.2"

### Elemento terminale destro o sinistro..

Left or right ending element.

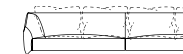

Art. DLNT236 DX/SX  
L/W 236 H 67 P/D 97  
W 92.9" H 26.4" D 38.2"

### Elemento angolare destro o sinistro.

Left or right corner element.

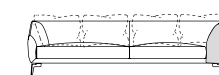

Art. DLNA244 DX/SX  
L/W 244 H 67 P/D 97  
W 96.1" H 26.4" D 38.2"

### Elemento angolare destro o sinistro.

Left or right corner element.

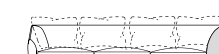

Art. DLNA284 DX/SX  
L/W 284 H 67 P/D 97  
W 111.8" H 26.4" D 38.2"



Art. PLN65  
L/W 65 H 36 P/D 85  
W 25.6" H 14.2" D 33.5"

Art. PLN92  
L/W 92 H 36 P/D 92  
W 36.2" H 14.2" D 36.2"

### Cuscino in piuma.

Cushion filled with down.



Art. CLN48  
L/W 48x48  
18.9" x 18.9"

# Blow

divano / sofa

Pagina\_Page 108

Divano. Struttura in metallo e legno. Imbottitura struttura e cuscino seduta in poliuretano a quote differenziate e con uno strato di schiuma Memory e trapunta in piuma d'oca sterilizzata. Rivestimento in pelle o tessuto.

Sofa. Frame in wood and steel. Upholstery with polyurethane foam of different densities with a layer of Memory foam and covered by a sterilized feathers quilt. Leather or fabric cover.

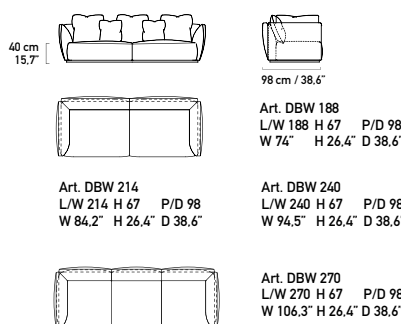
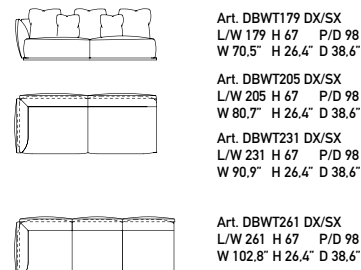
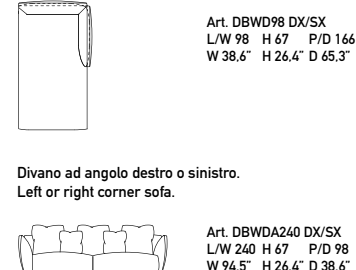
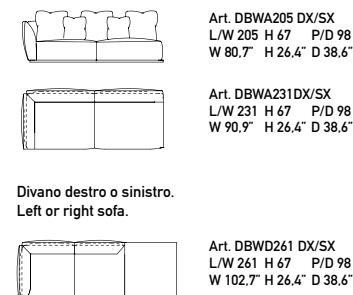
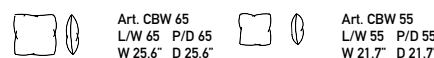
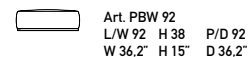

## BLOW

Divano.  
Sofa.Elemento terminale destro o sinistro.  
Left or right ending element.Chaise longue con bracciolo destro o sinistro.  
Chaise longue with armrest, left or right.Elemento angolare destro o sinistro.  
Left or right corner element.Divano ad angolo destro o sinistro.  
Left or right corner sofa.Divano destro o sinistro.  
Left or right sofa.Cuscino in piuma.  
Cushion filled with down.Pouf.  
Ottoman.

# Daytona

divano / sofa

Pagina\_Page 252-256

Poltrona e divano . Struttura in legno con cuscini imbottiti in gomma poliuretanic a densità differenziata e piuma sterilizzata. Base e gambe in acciaio verniciato o cromato. Rivestimento in pelle o tessuto

Armchair and sofa. Wooden frame. Cushions in polyurethane foam of different density and sterilized feathers. Steel base and legs painted or chrome-plated. Leather or fabric cover.

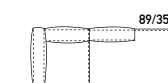
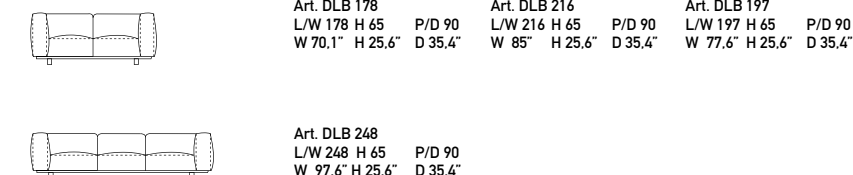
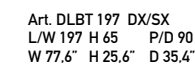
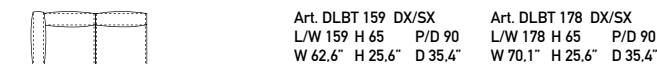
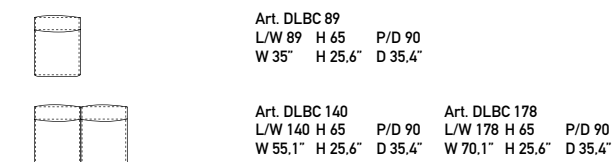
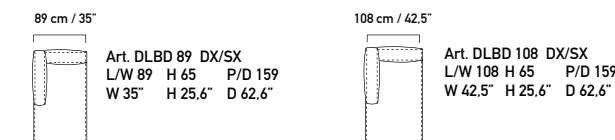
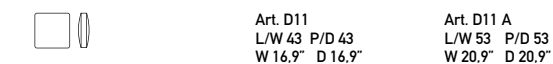
Poltrona.  
Armchair.Divani.  
Sofas.Elementi terminali destri o sinistri.  
Left or right ending elements.Elemento angolare destro o sinistro.  
Left or right corner element.Elementi centrali.  
Central elements.Chaise-longue con bracciolo destro o sinistro.  
Chaise-longue with left or right armrest.Pouf.  
Ottoman.Cuscino in piuma.  
Cushion filled with down.

# Cloud

divano / sofa

Pagina\_Page 142

Divano. Struttura in legno rivestita in gomma poliuretana e materasso in piuma sterilizzata. Base in estruso di alluminio e piedi in pressofusione di alluminio, finitura brillantato o laccato. Cuscini seduta in gomma poliuretana a densità differenziata e piuma sterilizzata. Rivestimento in pelle o tessuto.

Sofa. Wooden frame with polyurethane foam upholstery and sterilized feathers mattress. Aluminum structural section frame and die-cast aluminum feet, both polished or painted. Seat cushions in polyurethane foam of different density and sterilized feathers. Leather or fabric cover.

Divano.  
Sofa.

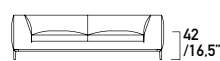

Art. DCL 190  
L/W 190 H 66 P/D 95  
W 74.8" H 26" D 37.4"

Art. DCL 216  
L/W 216 H 66 P/D 95  
W 85" H 26" D 37.4"

Art. DCL 242  
L/W 242 H 66 P/D 95  
W 95.3" H 26" D 37.4"

Art. DCL 268  
L/W 268 H 66 P/D 95  
W 105.5" H 26" D 37.4"

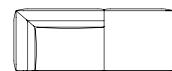

Art. DCL 242 Dx/Sx  
L/W 242 H 66 P/D 95  
W 95.3" H 26" D 37.4"

Elemento terminale e angolare destro o sinistro.  
Left or right, ending and corner element.

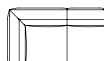

Art. DCLT 164 Dx/Sx L/W 164 H 66 P/D 95  
W 64.6" H 26" D 37.4"

Art. DCLT 190 Dx/Sx L/W 190 H 66 P/D 95  
W 74.8" H 26" D 37.4"

Art. DCLT 216 Dx/Sx L/W 216 H 66 P/D 95  
W 85" H 26" D 37.4"

Art. DCLT 242 Dx/Sx L/W 242 H 66 P/D 95  
W 95.3" H 26" D 37.4"

Elemento angolare destro o sinistro.  
Left or right corner element.

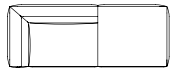

Art. DCLA 216 Dx/Sx  
L/W 216 H 66 P/D 95  
W 85" H 26" D 37.4"

Divano angolare destro o sinistro.  
Left or right corner sofa.

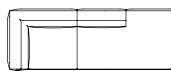

Art. DCLDA 242 Dx/Sx  
L/W 242 H 66 P/D 95  
W 95.3" H 26" D 37.4"

Chaise longue con bracciolo destro o sinistro.  
Chaise longue with armrest, left or right.

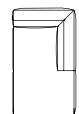

Art. DCLD 95  
L/W 95 H 66 P/D 164  
W 37.4" H 26" D 64.6"

Cuscino.  
Cushions.



Art. CCL 43  
43 x 43  
16.9" x 16.9"

Art. CCL 53  
53 x 53  
20.9" x 20.9"

Pouf.  
Ottoman.



Art. PCL 95  
L/W 95 H 42 P/D 95  
W 37.4" H 16.5" D 37.4"



# Ascot

divano / sofa

Pagina\_Page 326

Divano. Struttura in legno ricoperta in poliuretano indeformabile e fodera in fibra di poliestere. Cuscini spalliera in piuma sterilizzata. Cuscini seduta in poliuretano indeformabile e fodera in fibra di poliestere. Base in alluminio anodizzato lucido. Rivestimento in tessuto o pelle.

Sofa. Wooden frame covered in non-deformable polyurethane foam and polyester fiber lining. Back cushions in sterilized down. Seat cushions made of non-deformable polyurethane foam and polyester fiber lining. Base in polished anodized aluminium. Fabric or leather covers.



Divani.  
Sofas.



Art. DA 180  
L/W 180 H 74 P/D 93  
W 70.9" H 29.1" D 36.6"

Art. DA 224  
L/W 224 H 74 P/D 93  
W 88.2" H 29.1" D 36.6"

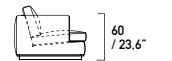

Art. DA 202  
L/W 202 H 74 P/D 93  
W 79.5" H 29.1" D 36.6"

Art. DA 246  
L/W 246 H 74 P/D 93  
W 96.8" H 29.1" D 36.6"

Divani angolari destri o sinistri.  
Corner sofas, left or right.

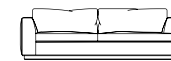

Art. DAA 224 DX/SX  
L/W 224 H 74 P/D 93  
W 88.2" H 29.1" D 36.6"



Art. DAA 246 DX/SX  
L/W 246 H 74 P/D 93  
W 96.8" H 29.1" D 36.6"



Art. DADA 246 DX/SX  
L/W 246 H 74 P/D 93  
W 96.8" H 29.1" D 36.6"

Elementi terminali, destro e sinistro.  
Left or right ending element.

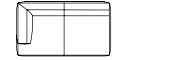

Art. DAT 158 DX/SX  
L/W 158 H 74 P/D 93  
W 62.2" H 29.1" D 36.6"

Art. DAT 180 DX/SX  
L/W 180 H 74 P/D 93  
W 70.9" H 29.1" D 36.6"

Art. DAT 202 DX/SX  
L/W 202 H 74 P/D 93  
W 79.5" H 29.1" D 36.6"

Art. DAT 224 DX/SX  
L/W 224 H 74 P/D 93  
W 88.2" H 29.1" D 36.6"

Elemento angolare destro o sinistro.  
Corner element, left or right.



Art. DAA 123 DX/SX  
L/W 123 H 74 P/D 93  
W 48.4" H 29.1" D 36.6"

Chaise-longue con bracciolo destro o sinistro.  
Chaise-longue with left or right armrest.



Art. DAD 112 DX/SX  
L/W 112 H 74 P/D 163  
W 44.1" H 29.1" D 64.2"

Dormeuse, destro o sinistro.  
Sofa, left or right armrest.



Art. DAD 246 DX/SX  
L/W 246 H 74 P/D 93  
W 96.8" H 29.1" D 36.6"

Pouf.  
Ottoman.

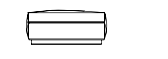

Art. DAP 90  
L/W 90 H 39 P/D 93  
W 35.4" H 15.4" P/D 93

# Haero

divano / sofa

Pagina\_Page 294

Divano. Struttura in legno ricoperta in gomma poliuretana e fodera in fibra di poliestere. Cuscini in poliuretano a densità differenziata e dacron. Base in trafilato di alluminio spazzolato o verniciato. Rivestimento in tessuto o pelle.

Sofa. Wooden frame covered with polyurethane foam and polyester fiber lining. Cushions in polyurethane foam of different density and dacron. Base in brushed or painted aluminium. Fabric or leather covers.

Divani.  
Sofas.

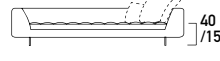

Art. D1  
L/W 173 H 64 P/D 97  
W 68.1" H 25.2" D 38.2"

Art. D2  
L/W 209 H 64 P/D 97  
W 82.3" H 25.2" D 38.2"

Art. D3  
L/W 245 H 64 P/D 97  
W 96.4" H 25.2" D 38.2"

Dormeuse, destra o sinistra.  
Sofa, left or right.

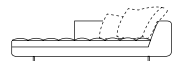

Art. D4 DX/SX  
L/W 200 H 64 P/D 87.5  
W 78.7" H 25.2" D 34.4"

Pouf.  
Ottoman.



Art. D10  
L/W 105 H 40 P/D 105  
W 41.3" H 15.7" D 41.3"

Letto.  
Day bed.



Art. D9  
L/W 192.5 H 59 P/D 87.5  
W 75.8" H 23.2" D 34.4"

Cuscini in piuma.  
Cushions filled with down.



Art. D11  
L/W 43 P/D 43  
W 16.9" D 16.9"

Art. D11 A  
L/W 53 P/D 53  
W 20.9" D 20.9"



# Dover

divano / sofa

Pagina\_Page 236

Poltrona e divano. Struttura in legno rivestita in poliuretano e fodera in fibra di poliestere. Cuscino seduta in gomma poliuretana a densità differenziata e Dacron. Cuscino spalliera in piuma sterilizzata. Gambe in acciaio cromato. Rivestimento in tessuto o pelle.

Armchair and sofa. Wooden frame covered with polyurethane foam and polyester fiber lining. Seat cushion in polyurethane foam of different density and Dacron. Back cushion in sterilized feathers. Chrome-plated steel legs. Fabrics or leather covers.

Poltrona.  
Armchair.



Art. DDO 82  
L/W 82 H 80 P/D 95  
W 32.3" H 31.5" D 37.4"

Divani.  
Sofas.

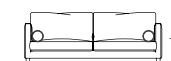

Art. DDO 192  
L/W 192 H 80 P/D 95  
W 75.6" H 31.5" D 37.4"

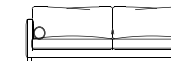

Art. DDO 232  
L/W 232 H 80 P/D 95  
W 91.3" H 31.5" D 37.4"

Pouf.  
Ottoman.



Art. DDO 95  
L/W 95 H 40 P/D 95  
W 37.4" H 15.7" D 37.4"

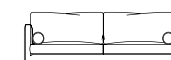

Art. DDO 212  
L/W 212 H 80 P/D 95  
W 83.5" H 31.5" D 37.4"



Art. DDO 252  
L/W 252 H 80 P/D 95  
W 99.2" H 31.5" D 37.4"



# Portofino / Portofino XL

divano / sofa

Pagina\_Page 188

Divano. Struttura in legno rivestita in schiuma di poliuretano flessibile e fodera in fibra di poliestere. Cuscini in gomma poliuretana a densità differenziata e dacron. Cuscini spalliera e braccioli in piuma sterilizzata. Telaio base in estruso d'alluminio e piedi in pressofusione di alluminio, brillantato o laccato. Rivestimento in pelle o tessuto.

Sofa. Wooden frame with flexible polyurethane foam and polyester fiber lining. Polyurethane foam of different density and dacron cushions. Arm and back cushions in sterilized feathers. Aluminium structural section frame and die-cast polished or lacquered aluminium feet. Leather or fabric covers

## PORTOFINO

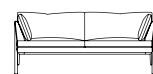
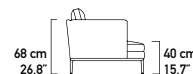
Divani.  
Sofas.

Art. DPF 168  
L/W 168 H 96 P/D 96  
W 66.1" H 37.8" D 37.8"

Art. DPF 192  
L/W 192 H 96 P/D 96  
W 75.6" H 37.8" D 37.8"

Art. DPF 216  
L/W 216 H 96 P/D 96  
W 85" H 37.8" D 37.8"

Art. DPF 236  
L/W 236 H 96 P/D 96  
W 92.9" H 37.8" D 37.8"

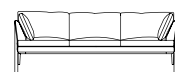

Art. DPF 272  
L/W 272 H 96 P/D 96  
W 107" H 37.8" D 37.8"

Elemento terminale destro o sinistro.  
Left or right ending element.



Art. DPFT 164 DX/SX  
L/W 164 H 96 P/D 96  
W 64.6" H 37.8" D 37.8"

Art. DPFT 176 DX/SX  
L/W 176 H 96 P/D 96  
W 69.3" H 37.8" D 37.8"

Art. DPFT 188 DX/SX  
L/W 188 H 96 P/D 96  
W 74" H 37.8" D 37.8"

Art. DPFT 212 DX/SX  
L/W 212 H 96 P/D 96  
W 83.5" H 37.8" D 37.8"

Art. DPFT 232 DX/SX  
L/W 232 H 96 P/D 96  
W 91.3" H 37.8" D 37.8"

Divano angolare destro o sinistro.  
Left or right corner sofa.



Art. DPFA 272 DX/SX  
L/W 272 H 96 P/D 96  
W 107" H 37.8" D 37.8"



Art. DPFA 176 DX/SX  
L/W 176 H 96 P/D 96  
W 69.3" H 37.8" D 37.8"

Divano destro o sinistro.  
Left or right sofa.



Art. DPDF 233 DX/SX  
L/W 233 H 96 P/D 96  
W 91.7" H 37.8" D 37.8"

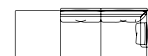

Art. DPDF 268 DX/SX  
L/W 268 H 96 P/D 96  
W 105.5" H 37.8" D 37.8"

115 cm  
44.9"

92 cm  
36.2"

Elemento destro o sinistro.  
Left or right element.



Art. DPFE 160 DX/SX  
L/W 160 H 96 P/D 96  
W 63" H 37.8" D 37.8"

Art. DPFE 184 DX/SX  
L/W 184 H 96 P/D 96  
W 72.4" H 37.8" D 37.8"



Art. DPDF 96 DX/SX  
L/W 96 H 96 P/D 164  
W 37.8" H 37.8" D 44.6"

Elemento centrale.  
Central element.



Art. DPFC 160  
L/W 160 H 96 P/D 96  
W 63" H 37.8" D 37.8"

Art. DPFC 184  
L/W 184 H 96 P/D 96  
W 72.4" H 37.8" D 37.8"

Art. DPFC 232  
L/W 232 H 96 P/D 96  
W 91.3" H 37.8" D 37.8"

Pouf. Ottoman.



Art. PPF 70  
L/W 70 H 42 P/D 46  
W 27.6" H 16.5" D 18.1"

Art. PPF 46  
L/W 46 H 42 P/D 46  
W 18.1" H 16.5" D 18.1"

Art. PPF 92  
L/W 92 H 42 P/D 92  
W 36.2" H 16.5" D 36.2"

Cuscino in piuma.  
Cushion filled with down.



Art. CPF 47  
47 x 47  
18.5" x 18.5"

Cuscino in piuma con rivestimento in pelle intrecciata a mano.  
Cushion filled with down with hand-woven leather cover.



Art. CPF 47 I  
47 x 47  
18.5" x 18.5"

## PORTOFINO XL

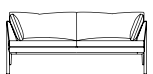
Divani.  
Sofas.

Art. DPFXL 192  
L/W 192 H 96 P/D 108  
W 75.6" H 37.8" D 42.5"

Art. DPFXL 216  
L/W 216 H 96 P/D 108  
W 85" H 37.8" D 42.5"

Art. DPFXL 236  
L/W 236 H 96 P/D 108  
W 92.9" H 37.8" D 42.5"

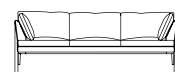

Art. DPFXL 272  
L/W 272 H 96 P/D 108  
W 107" H 37.8" D 42.5"

Elemento terminale destro o sinistro.  
Left or right ending element.



Art. DPFXL 176 DX/SX  
L/W 176 H 96 P/D 108  
W 69.3" H 37.8" D 42.5"

Art. DPFXL 188 DX/SX  
L/W 188 H 96 P/D 108  
W 74" H 37.8" D 42.5"

Art. DPFXL 212 DX/SX  
L/W 212 H 96 P/D 108  
W 83.5" H 37.8" D 42.5"

Art. DPFXL 232 DX/SX  
L/W 232 H 96 P/D 108  
W 91.3" H 37.8" D 42.5"

Divano angolare destro o sinistro.  
Left or right corner sofa.

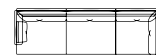

Art. DPFXLA 284 DX/SX  
L/W 284 H 96 P/D 108  
W 111.8" H 37.8" D 42.5"



Art. DPFXLA 188 DX/SX  
L/W 188 H 96 P/D 108  
W 74" H 37.8" D 42.5"

Divano destro o sinistro.  
Left or right sofa.

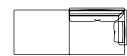

Art. DPFXLD 233 DX/SX  
L/W 233 H 96 P/D 108  
W 91.7" H 37.8" D 42.5"



Art. DPFXLD 268 DX/SX  
L/W 268 H 96 P/D 108  
W 105.5" H 37.8" D 42.5"

115 cm  
44.9"

92 cm  
36.2"

Elemento destro o sinistro.  
Left or right element.



Art. DPFXLE 184 DX/SX  
L/W 184 H 96 P/D 108  
W 72.4" H 37.8" D 42.5"

Elemento centrale.  
Central element.



Art. DPFXLC 184  
L/W 184 H 96 P/D 108  
W 72.4" H 37.8" D 42.5"

Art. DPFXLC 232  
L/W 232 H 96 P/D 108  
W 91.3" H 37.8" D 42.5"

Cuscino in piuma.  
Cushion filled with down.



Art. CPF 47  
47x47  
18.5"x18.5"

Cuscino in piuma con rivestimento in pelle intrecciata a mano.  
Cushion filled with down with hand-woven leather cover.



Art. CPF 47 I  
47x47  
18.5"x18.5"

# Bahia / Big Bahia

divano / sofa

Pagina\_Page 214

Divano. Base in legno ricoperta in poliuretano indeformabile e fodera in fibra di poliestere. Spalliere e braccioli in metallo ricoperti in poliuretano schiumato a freddo. Cuscini in poliuretano a densità differenziata e piuma sterilizzata. Rivestimento in tessuto o pelle. Piedi in fusione d'alluminio lucidato.

Sofa. Base in wood covered in non-deformable polyurethane foam and polyester fiber lining. Backrest and arms in steel covered with cold shaped polyurethane foam. Cushions in polyurethane foam of different density and sterilized feathers. Fabric or leather covers. Feet in polished aluminium.

## BAHIA

Divani.  
Sofas.

Art. DBH 172  
L/W 172 H 77 P/D 96  
W 68" H 30" D 38"

Art. DBH 212  
L/W 212 H 77 P/D 96  
W 83" H 30" D 38"

Art. DBH 192  
L/W 192 H 77 P/D 96  
W 75" H 30" D 38"

Art. DBH 232  
L/W 232 H 77 P/D 96  
W 91" H 30" D 38"

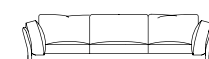

Art. DBH 250  
L/W 250 H 77 P/D 96  
W 98" H 30" D 38"

Divani angolari destri o sinistri.  
Corner sofas, left or right.



Art. DBH A272 DX/SX  
L/W 272 H 77 P/D 96  
W 107" H 30" D 38"

Art. DBH A282 DX/SX  
L/W 282 H 77 P/D 96  
W 111" H 30" D 38"

Elemento angolare destro o sinistro.  
Corner element, left or right.



Art. DBH A96  
L/W 96 H 77 P/D 96  
W 38" H 30" D 38"

Art. DBH A106 DX/SX  
L/W 106 H 77 P/D 96  
W 42" H 30" D 38"



Art. DBH A184 DX/SX  
L/W 184 H 77 P/D 96  
W 72" H 30" D 38"

Art. DBH A204 DX/SX  
L/W 204 H 77 P/D 96  
W 80" H 30" D 38"

Elementi terminali destri o sinistri.  
Left or right ending elements.



Art. DBH T96 DX/SX  
L/W 96 H 77 P/D 96  
W 38" H 30" D 38"

Art. DBH T106 DX/SX  
L/W 106 H 77 P/D 96  
W 42" H 30" D 38"

Art. DBH T116 DX/SX  
L/W 116 H 77 P/D 96  
W 46" H 30" D 38"



Art. DBH T164 DX/SX  
L/W 164 H 77 P/D 96  
W 66" H 30" D 38"

Art. DBH T204 DX/SX  
L/W 204 H 77 P/D 96  
W 80" H 30" D 38"

Art. DBH T184 DX/SX  
L/W 184 H 77 P/D 96  
W 72" H 30" D 38"

Art. DBH T224 DX/SX  
L/W 224 H 77 P/D 96  
W 88" H 30" D 38"

Divano destro o sinistro.  
Right or left sofa.

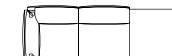

Art. DBH T272 DX/SX  
L/W 272 H 77 P/D 96  
W 107" H 30" D 38"

Art. DBH T282 DX/SX  
L/W 282 H 77 P/D 96  
W 111" H 30" D 38"

Chaise-longue con bracciolo  
destro o sinistro. Chaise-longue  
with left or right armrest.



Art. DBH D96 DX/SX  
L/W 96 H 77 P/D 164  
W 38" H 30" D 65"

Cuscino in piuma.  
Cushion filled with down.



Art. CBH 43  
L/W 43 H 43  
W 16.9" H 16.9"

Art. CBH 53  
L/W 53 H 53  
W 20.9" H 20.9"

Pouf.  
Ottoman.



Art. DBH P88  
L/W 88 H 37 P/D 88  
W 35" H 15" D 35"

## BIG BAHIA

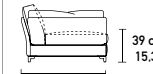
Divani.  
Sofas.

Art. DBB H212  
L/W 212 H 77 P/D 106  
W 83" H 30" D 42"

Art. DBB H232  
L/W 232 H 77 P/D 106  
W 91" H 30" D 42"

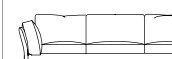

Art. DBB H250  
L/W 250 H 77 P/D 106  
W 98" H 30" D 42"

Elemento angolare destro o sinistro.  
Corner element, left or right.



Art. DBB HA106  
L/W 106 H 77 P/D 106  
W 42" H 30" D 42"



Art. DBB HA204 DX/SX  
L/W 204 H 77 P/D 106  
W 80" H 30" D 42"

Elementi terminali destri o sinistri.  
Left or right ending elements.



Art. DBB HT106 DX/SX  
L/W 106 H 77 P/D 106  
W 42" H 30" D 42"



Art. DBB HT164 DX/SX  
L/W 164 H 77 P/D 106  
W 65" H 30" D 42"

Art. DBB HT204 DX/SX  
L/W 204 H 77 P/D 106  
W 80" H 30" D 42"

Art. DBB HT184 DX/SX  
L/W 184 H 77 P/D 106  
W 72" H 30" D 42"

Art. DBB HT224 DX/SX  
L/W 224 H 77 P/D 106  
W 88" H 30" D 42"

Chaise-longue con bracciolo destro o sinistro.  
Chaise-longue with left or right armrest.



Art. DBB HD106 DX/SX  
L/W 106 H 77 P/D 164  
W 42" H 30" D 65"

Cuscino in piuma.  
Cushion filled with down.



Art. CBH 43  
L/W 43 H 43  
W 16.9" H 16.9"

Art. CBH 53  
L/W 53 H 53  
W 20.9" H 20.9"

Pouf.  
Ottoman.



Art. DBB HP98  
L/W 98 H 37 P/D 98  
W 39" H 15" D 39"



## Dublin

divano / sofa

Pagina\_Page 362

Divano. Struttura in legno ricoperta in poliuretano e fodera in fibra di poliestere. Cuscini seduta in poliuretano a densità differenziata e dacron. Cuscini spalliera in piuma sterilizzata. Rivestimento in tessuto o pelle.

Sofa. Wooden frame covered with polyurethane foam and polyester fiber lining. Seat cushions in polyurethane foam of different density and Dacron. Back cushions in sterilized feathers. Fabric or leather covers.

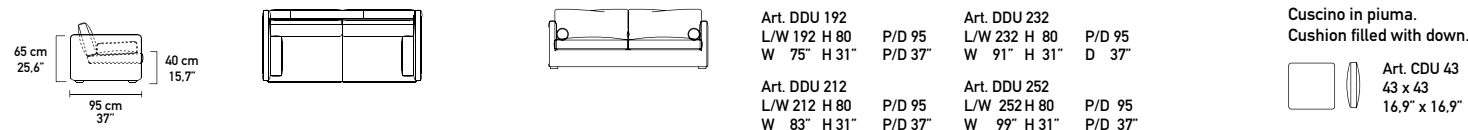

## Carol

poltrona\_pouf / armchair\_ottoman

Pagina\_Page 38

Poltrona. Struttura in Polymex rivestita in gomma poliuretanicca e fibra. Seduta in gomma poliuretanicca e fibra con uno strato di schiuma Memory. Poggiatesta magnetico e regolabile. Piedi in acciaio cromato, verniciato, inox finitura Peltrox, nickel nero o in rovere verniciato. Rivestimento in pelle o tessuto. Cuciture "punto cavallo" tono su tono; cuciture a contrasto su richiesta.

Armchair. Frame in Polymex with polyurethane foam and fiber upholstery. Seat in polyurethane foam and fiber with a layer of Memory foam. Magnetic adjustable headrest. Feet in chrome-plated or painted steel, in stainless steel, Peltrox finish, black nickel or in painted oak. Leather or fabric cover. "Horse seam" stitching in the same colour tone; contrasting thread by request.

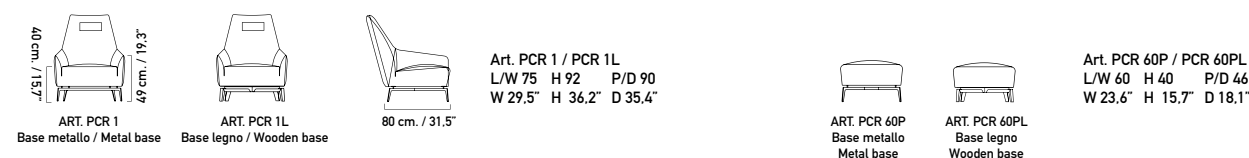

## Céline

poltrona / armchair

Pagina\_Page 22

Poltrona. Struttura in legno rivestita in gomma poliuretanicca e fibra. Seduta in gomma poliuretanicca e fibra con uno strato di schiuma Memory. Piedi in acciaio cromato, verniciato, inox finitura Peltrox, nickel nero o in rovere verniciato. Rivestimento in pelle o tessuto. Cuciture "punto cavallo" su richiesta.

Armchair. Wooden frame with polyurethane foam and fiber upholstery. Seat in polyurethane foam and fiber with a layer of Memory foam. Feet in chrome-plated or painted steel, in stainless steel, Peltrox finish, black nickel or in painted oak. Leather or fabric cover. "Horse seam" stitching by request.



## Flexa

poltroncina\_sedia / lounge chair\_chair

Pagina\_Page 116-120

Poltroncina e sedia. Struttura in metallo rivestita in poliuretano schiumato a freddo con uno strato di schiuma Memory e Dacron. Rivestimento in pelle o tessuto. Poltroncina con gambe in acciaio verniciato o inox finitura Peltrox. Sedia con gambe in acciaio cromato o verniciato.

Lounge chair and chair. Cold shaped polyurethane foam padded steel frame with a layer of Memory foam and Dacron. Fabric or leather cover. Lounge chair with legs in painted steel or in stainless steel, Peltrox finish. Chair with legs in chrome-plated or painted steel.

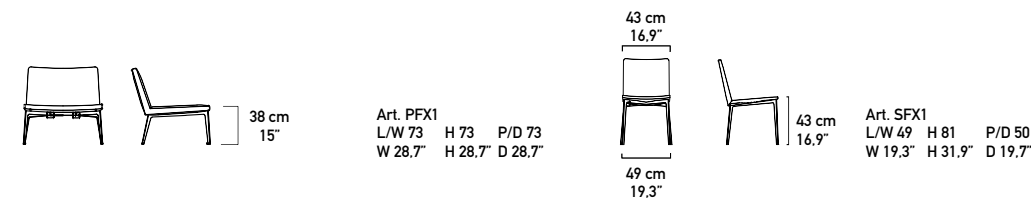

## Wing lounge chair / Wing stool

poltroncina\_sgabello / lounge chair\_stool

Pagina\_Page 338

### Art. PW1

Poltroncina. Seduta e spalliera in schiuma di poliuretano flessibile a freddo. Rivestimento in tessuto o pelle. Struttura in acciaio tagliata al laser, cromata o laccata.

Lounge chair. Seat and back made of cold shaped polyurethane foam. Leather or fabric covers. Laser-cut steel frame, chrome-plated or painted.

### Art. SGW1

Sgabello. Seduta in poliuretano stampato. Rivestimento in ecopelle o pelle. Struttura in acciaio tagliata al laser, cromata o laccata..

Stool. Seat made of moulded polyurethane foam. Leather or synthetic leather covers. Laser-cut steel frame, chrome-plated or painted.

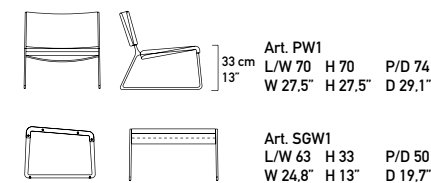

### Art. PW2

Poltroncina. Seduta e spalliera in corda intrecciata colore naturale, nera o bianca. Struttura in acciaio tagliata al laser, cromata o laccata.

Lounge chair. Seat and back made of woven cord in either natural, black or white color. Laser-cut steel frame, chrome-plated or painted.

### Art. SGW2

Sgabello come sopra / Stool as above.

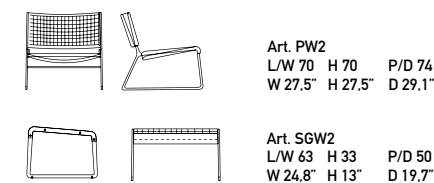

### Art. PW3 outdoor

Poltroncina per esterno. Seduta in cordino lavabile composto da filato (nastro) in film poleofinico nei colori bianco, nero o naturale. Struttura in acciaio tagliato al laser laccato bianco, nero o alluminio.

Chair for outdoor use. Seat in washable cord consisting of yarn (strip) made of polyolefinic film in the colours: white, black or natural. Frame made of laser-cut steel, lacquered white, black or aluminium.

### Art. SGW3 outdoor

Sgabello come sopra / Stool as above.

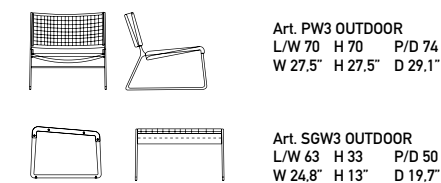

# Samoa

poltroncina / lounge chair

Pagina\_Page 240

Poltroncina. Struttura in tubolare di acciaio cromato o laccato. Seduta e spalliera in schiuma di poliuretano flessibile a freddo e rivestito in pelle, fintapelle o cavallino. Disponibile con seduta e spalliera in pelle intrecciata (Art. PS 11)

Lounge Chair. Tubular steel frame, chrome-plated or painted. Seat and back in cold shaped polyurethane foam, covered in leather, synthetic leather or cow hide. Available with seat and back in woven leather (Art. PS 11)

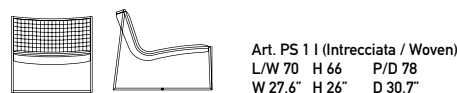
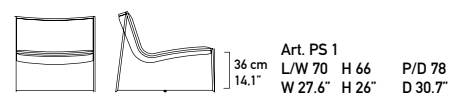

# Atlanta

poltroncina\_pouf / lounge chair\_ottoman

Pagina\_Page 366

Poltrona con braccioli (art. D7/B), senza braccioli (art. D7) e pouf (art. D8). Struttura in acciaio cromato. Rivestimento imbottito e trapuntato in pelle o tessuto.

Armchair (art. D7/B), lounge chair (art. D7) and ottoman (art. D8). Frame in chrome-plated steel. Quilted cover in leather or fabric.

Poltrona con braccioli.  
Longue chair.



Poltrona.  
Armchair.



Pouff.  
Ottoman.

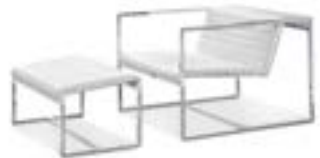

# Pady

poltroncina / armchair

Pagina\_Page 166

Poltroncina. Struttura in acciaio rivestita in schiuma di poliuretano flessibile a freddo e Dacron. Base in acciaio laccato, cromato o in acciaio inox finitura Peltrox. Rivestimento in pelle o tessuto.

Armchair. Steel frame covered in cold shaped polyurethane foam and Dacron. Steel base, painted or chrome-plated or stainless steel base with "Peltrox" finish. Leather or fabric cover.

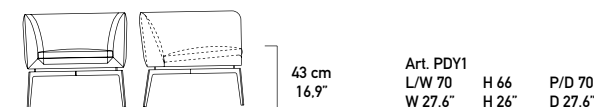

# Dhalia

poltroncina / armchair

Pagina\_Page 206

Poltroncina. Struttura in acciaio rivestita in schiuma di poliuretano flessibile a freddo. Rivestimento in pelle o in tessuto. Piedi in fusione di alluminio o ruote (art. PDH1R).

Armchair. Cold shaped polyurethane foam padded steel frame. Leather or fabric covers. Die-cast aluminium feet or on wheels (art. PDH1R).

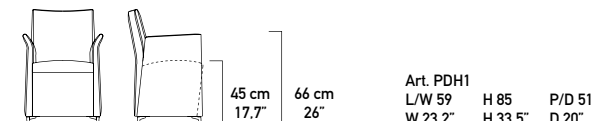

# Club

poltroncina / armchair

Pagina\_Page 302

Poltroncina. Struttura in acciaio rivestita in schiuma di poliuretano flessibile a freddo. Rivestimento in pelle, tessuto o cavallino. Gambe in acciaio cromato.

Armchair. Steel frame covered in cold shaped polyurethane foam. Leather, fabric or cow hide covers. Chrome-plated steel legs.



# T-Gong

tavolino / coffee table

Pagina\_Page 64 - 164

Tavolino. Piano e basamento in acciaio verniciato bronzo metallizzato satinato, in acciaio inox finitura Peltrox o in acciaio satinato verniciato, finitura "Rame". Inserti metallici in ottone satinato.

Coffee table. Top and base in the following finishes: painted steel with a metallic bronze satin finish, stainless steel with "Peltrox" finish or painted satin steel with copper-coloured finish. Brass satin inserts.

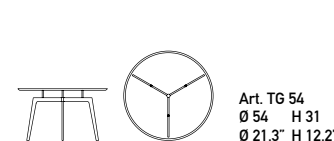

Art. TG 54  
Ø 54 H 31  
Ø 21.3" H 12.2"

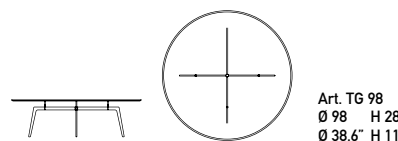

Art. TG 98  
Ø 98 H 28  
Ø 38.6" H 11"



Art. TG 48  
Ø 48 H 41  
Ø 18.9" H 16.1"



Art. TG 42  
Ø 42 H 51  
Ø 16.5" H 20.1"

# Poggio

tavolino / coffee table

Pagina\_Page 196

Tavolino. Piano in pietra acrilica, in marmo, in rovere termo-trattato a spicchi o in MDF laccato. Telaio base in profilo d'alluminio e piedi in pressofusione di alluminio, brillantato o laccato.

Coffee table. Acrylic stone, marble, heat-treated oak in segments or lacquered MDF top. Aluminium structural section frame and die-cast polished or lacquered aluminium feet.

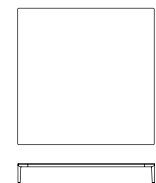

Art. TPGQ 140  
L/W 140 H 20 P/D 140  
W 55.1" H 7.9" D 55.1"

Art. TPGQ 91  
L/W 91.5 H 20 P/D 91.5  
W 36" H 7.9" D 36"

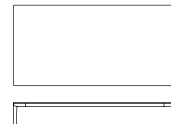

Art. TPGR 140  
L/W 140 H 20 P/D 70  
W 55.1" H 7.9" D 27.6"

Art. TPGQ 80  
L/W 80 H 20 P/D 80  
W 31.5" H 7.9" D 31.5"

# Harpa

tavolino / coffee table

Pagina\_Page 254

Tavolino. Base in acciaio cromato o laccato. Piano disponibile in: pietra acrilica bianca, marmo, rovere termotrattato a spicchi, noce "Nazionale" o MDF laccato.

Coffee table. Chrome-plated or painted steel base. Top available in: white acrylic stone, marble, heat-treated oak in segments, Italian walnut or in lacquered MDF.

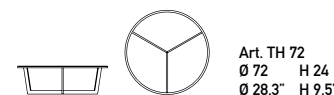

Art. TH 72  
Ø 72 H 24  
Ø 28.3" H 9.5"

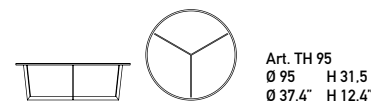

Art. TH 95  
Ø 95 H 31.5  
Ø 37.4" H 12.4"



Art. TH 43  
Ø 43 H 48  
Ø 16.9" H 19.9"

# Bloom

tavolino / side table

Pagina\_Page 218

Tavolino. Base in acciaio cromato o laccato. Piano in pietra acrilica bianca o laccata.

Side table. Frame in chrome-plated or painted steel. Top in white or lacquered acrylic stone.

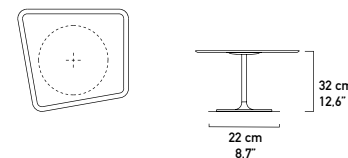

Art. TB 33  
L/W 35 H 32 P/D 35  
W 14" H 12.6" D 14"

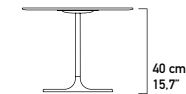

Art. TB 41  
L/W 35 H 40 P/D 35  
W 14" H 15.7" D 14"

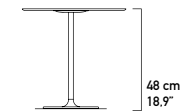

Art. TB 49  
L/W 35 H 48 P/D 35  
W 14" H 18.9" D 14"

# Up

tavolino / coffee table

Pagina\_Page 370

Tavolino. Struttura in tubo di acciaio cromato o laccato. Piano in rovere, in MDF laccato o in marmo.

Coffee table. Frame in chrome-plated or painted tubular steel. Top in oak, in lacquered MDF or in marble.

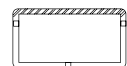
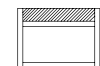

UP1 Art. T8  
L/W 50 H 22 P/D 88.3  
W 19.7" H 8.7" D 34.8"

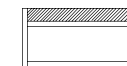

UP2 Art. T9  
L/W 90 H 22 P/D 88.3  
W 35.4" H 8.7" D 34.8"

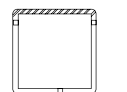
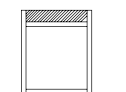

UP3 Art. T10  
L/W 40 H 50 P/D 42  
W 15.7" H 19.7" D 16.5"

# Bench

tavolino / coffee table

Pagina\_Page 300

Tavolino in rovere o in MDF laccato con due cassetti interni laterali.

Coffee table in oak or in lacquered MDF with 2 side drawers.

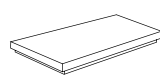
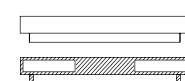

Art. T6  
L/W 126 H 19 P/D 86  
W 49.6" H 7.5" D 33.8"

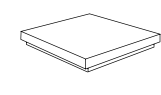
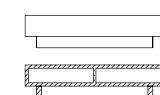

Art. T7  
L/W 86 H 19 P/D 86  
W 33.8" H 7.5" D 33.8"

# Club

tavolino / coffee table

Pagina\_Page 304

Tavolino. Base in acciaio cromato o laccato. Piano in rovere, in MDF laccato o in marmo.

Coffee table. Chrome-plated or painted steel frame. Top in oak, in lacquered MDF or in marble.

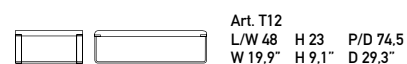

Art. T12  
L/W 48 H 23 P/D 74,5  
W 19.9" H 9.1" D 29.3"



Art. T13  
L/W 76 H 23 P/D 76  
W 29.9" H 9.1" D 29.9"

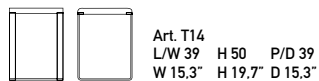

Art. T14  
L/W 39 H 50 P/D 39  
W 15.3" H 19.7" D 15.3"

# Daytona

tavolino / coffee table

Pagina\_Page 258

Tavolino. Base in acciaio cromato o laccato. Piano in rovere o in MDF laccato.

Coffee table. Chrome-plated or painted steel frame. Top in oak or in lacquered MDF.

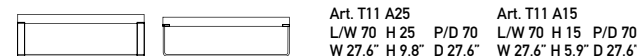

Art. T11 A25  
L/W 70 H 25 P/D 70  
W 27.6" H 9.8" D 27.6"



Art. T11 A15  
L/W 70 H 15 P/D 70  
W 27.6" H 5.9" D 27.6"

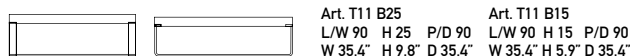

Art. T11 B25  
L/W 90 H 25 P/D 90  
W 35.4" H 9.8" D 35.4"

Art. T11 B15  
L/W 90 H 15 P/D 90  
W 35.4" H 5.9" D 35.4"

# Sax

tavolino / coffee table

Pagina\_Page 84

Tavolino. Struttura in acciaio cromato, verniciato o Nickel nero. Piani in marmo, rovere termotrattato o MDF laccato lucido o opaco.

Coffee table. Frame in chrome-plated or painted steel or black Nickel. Top in marble, heat-treated oak or glossy or matt lacquered MDF.

Tavolino con piano superiore soltanto. Struttura in acciaio cromato o verniciato o Nickel nero. Piani in marmo, rovere termotrattato o MDF laccato lucido o opaco.

Coffee table with upper top only. Frame in chrome-plated or painted steel or black Nickel. Top in marble, heat-treated oak or glossy or matt lacquered MDF.

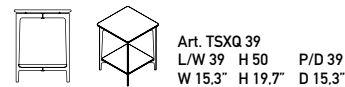

Art. TSXQ 39  
L/W 39 H 50 P/D 39  
W 15.3" H 19.7" D 15.3"

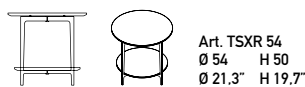

Art. TSXR 54  
Ø 54 H 50  
Ø 21.3" H 19.7"

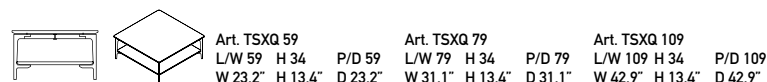

Art. TSXQ 59  
L/W 59 H 34 P/D 59  
W 23.2" H 13.4" D 23.2"

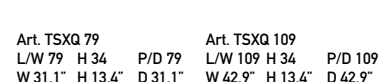

Art. TSXQ 79  
L/W 79 H 34 P/D 79  
W 31.1" H 13.4" D 31.1"

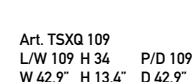

Art. TSXQ 109  
L/W 109 H 34 P/D 109  
W 42.9" H 13.4" D 42.9"



Art. TSXQ 39B  
L/W 39 H 50 P/D 39  
W 15.3" H 19.7" D 15.3"

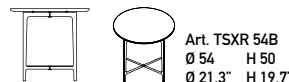

Art. TSXR 54B  
Ø 54 H 50  
Ø 21.3" H 19.7"

# Sirio

tavolino / coffee table

Pagina\_Page 28

Tavolino. Gamba in fusione di alluminio e cornice in acciaio inox verniciato, brillantato, cromato, nickel nero o verniciato "champagne". Piano in rovere termotrattato a spicchi, noce "Nazionale" a spicchi, MDF laccato lucido o opaco o in marmo.

Coffee table. Legs in die-cast aluminium and stainless steel edge in painted, polished, chrome-plated, black nickel or painted "champagne" tone. Top in heat-treated oak in segments, Italian walnut in segments, in glossy or matt lacquered MDF or in marble.

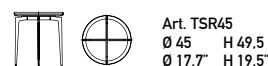

Art. TSR45  
Ø 45 H 49,5  
Ø 17.7" H 19.5"



Art. TSR55  
Ø 55 H 39  
Ø 21.6" H 15.3"

Art. TSR70  
Ø 70 H 39  
Ø 27.5" H 15.3"

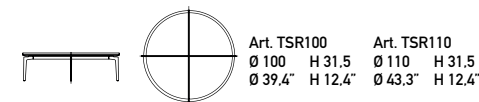

Art. TSR100  
Ø 100 H 31,5  
Ø 39.4" H 12.4"

Art. TSR110  
Ø 110 H 31,5  
Ø 43.3" H 12.4"

# Altea

credenza / sideboard

Pagina\_Page 260

Credenza a due ante in rovere o in MDF laccato. Vetrinetta in cristallo temperato spessore 6 mm. rivestita in cuoio. Luce interna. Due cassetti ed un ripiano interno.

Sideboard in oak or in lacquered MDF. Two doors. Tempered glass cabinet, 6 mm. thick with hide clad. Inside light. Two inner drawers and one shelf.

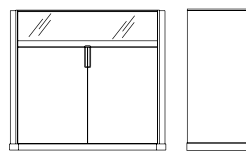

Art. CA1  
L/W 126 H 114 P/D 49,5  
W 49.6" H 44.9" D 19.5"

# Denver

credenza / sideboard

Pagina\_Page 332

Credenza alta in MDF laccato con due ante scorrevoli. Anta a ribalta in cristallo con luce interna. Piani in marmo "bianco Michelangelo", "Calacatta Oro" o in "Pietra Serena".

Sideboard in lacquered MDF with two sliding doors. Folding door in glass with inside light. Tops in "white Michelangelo", "white gold Calacatta" marble or in "Serena stone".

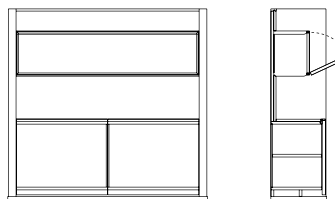

Art. CDV1  
L/W 180 H 175 P/D 50  
W 70.9" H 68.9" D 19.7"

# Side

credenza / sideboard

Pagina\_Page 94

Credenza in MDF laccato con quattro cassetti e due ante laterali. Base e maniglie in alluminio brillantato o verniciato. Top in pietra acrilica verniciata.

Sideboard in lacquered MDF with four drawers and two side doors. Base and handles in polished or painted aluminum. Top in painted acrylic stone.

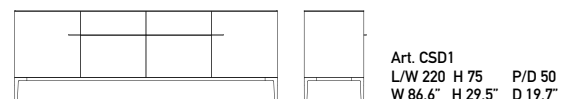

# Side Up

credenza / sideboard

Pagina\_Page 124

Credenza in MDF laccato. Base e maniglie in alluminio brillantato o verniciato. Vano interno attrezzato con specchio, ripiani e 3 cassetti in rovere termotrattato o noce "Nazionale". Top in pietra acrilica verniciata. Luce interna su richiesta.

Sideboard in lacquered MDF. Base and handles in polished or painted aluminum. Inside compartment equipped with mirror, shelves and 3 drawers in heat-treated oak or Italian walnut. Top in painted acrylic stone. Led lighting on demand.

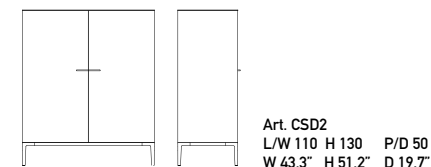

# Edomadia

credenza / sideboard

Pagina\_Page 310

Credenza in MDF laccato con cassetti. Base in acciaio cromato o verniciato. Vassoio porta bottiglie in alluminio su richiesta.

Sideboard in lacquered MDF with two drawers. Chrome-plated, or painted steel base. Aluminium bottle rack on demand.

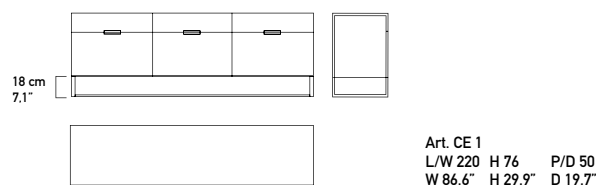

# Portland

credenza / sideboard

Pagina\_Page 272

Credenza in MDF laccato o in rovere con ante scorrevoli e quattro cassettini. Piani in marmo "bianco Michelangelo", "Calacatta oro", "nero Marquinia", "Emperador" o in "pietra Serena".

Sideboard in oak or in lacquered MDF with sliding doors and four little drawers. Tops in "white Michelangelo", "white gold Calacatta", "black Marquinia" or "Emperador" marble or in "Serena stone".

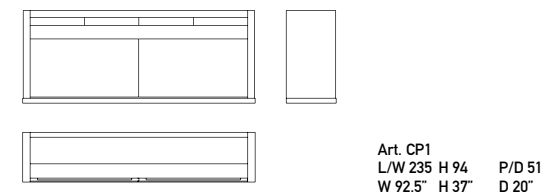

# Kubit

credenza / sideboard

Pagina\_Page 54

Credenza in MDF laccato o in rovere con quattro cassetti e due ante laterali. Piano in marmo "bianco Michelangelo", "Calacatta oro", "nero Marquinia", "Emperador" o in "pietra Serena".

Base in alluminio spazzolato anodizzato e verniciato. Vassoio portabottiglie in alluminio su richiesta.

Sideboard in oak or in lacquered MDF with four drawers and two side doors. Top in "white Michelangelo", "white gold Calacatta", "black Marquinia", "Emperador" marble or in "Serena stone". Painted brushed aluminium base. Aluminium bottle rack on demand.

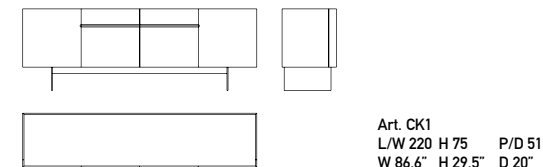

# Stone

tavolo / table

Pagina\_Page 270

Tavolo. Base in acciaio inox lucidato a specchio. Piano disponibile in marmo o in Cemento Ductal® colore "French grey".

Table. Stainless steel base, polished to a mirror finish. Top available in marble or in Ductal® Concrete, "French grey" colour.

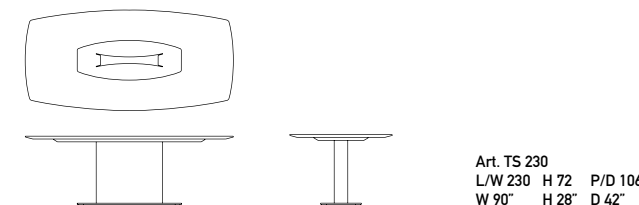

# Loto

tavolo allungabile / extendable table

Pagina\_Page 264

Tavolo rettangolare allungabile. Base in acciaio inox lucidato a specchio. Piano rettangolare allungabile disponibile in rovere o in MDF laccato laminato liquido.

Extendable rectangular table. Stainless steel base, polished to a mirror finish. Extendable top available in oak or in liquid laminate lacquered MDF.

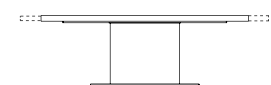

Art. TL 210 A  
L/W 210/268 H 74 P/D 95  
W 82.7"/105.5" H 29.1" D 37.4"

# Loto

tavolo / table

Pagina\_Page 266

Tavolo ovale. Base in acciaio inox lucidato a specchio. Piano ovale disponibile in: marmo o MDF laccato laminato liquido.

Oval table. Stainless steel base, polished to a mirror finish. Oval top available in: marble or liquid laminate lacquered MDF.

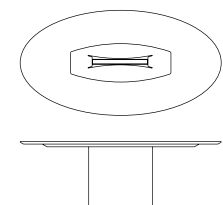

Art. TL 220 O  
L/W 220 H 72 P/D 115  
W 86.6" H 28.3" D 45.3"

Art. TL 260 O  
L/W 260 H 72 P/D 130  
W 102.4" H 28.3" D 51.2"

# XT

tavolo / table

Pagina\_Page 306

Tavolo. Struttura in acciaio inox spazzolato. Piano in rovere o in MDF laccato lucido o opaco.

Table. Brushed stainless steel legs. Top in oak or in glossy or matt lacquered MDF.

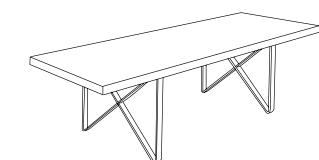

Art. T3  
L/W 190 H 73.5 P/D 90  
W 74.8" H 28.9" D 35.4"

Art. T3A  
L/W 220 H 73.5 P/D 90  
W 86.6" H 28.9" D 35.4"

Art. T3B  
L/W 240 H 73.5 P/D 90  
W 94.5" H 28.9" D 35.4"

Art. T3C  
L/W 280 H 73.5 P/D 90  
W 110.2" H 28.9" D 35.4"

# Radar

tavolo / table

Pagina\_Page 334

Tavolo. Base in ghisa verniciata nera o bianca. Gamba in acciaio tagliato al laser cromata o verniciata. Piano in marmo o in MDF laccato laminato liquido.

Table. Basement in white or black-painted cast iron. Laser-cut steel bars chrome-plated or painted. Top in marble or in MDF painted in liquid laminate.

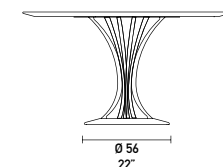

Art. TR 120  
Ø 120 H 73  
Ø 47.2" H 28.7"

Art. TR 137  
Ø 137 H 73  
Ø 53.9" H 28.7"

Art. TR 150  
Ø 150 H 73  
Ø 59" H 28.7"

# Layer

tavolo / table

Pagina\_Page 174

Tavolo. Struttura in acciaio rivestito in pietra acrilica bianca.

Table. Steel frame covered in white acrylic stone.

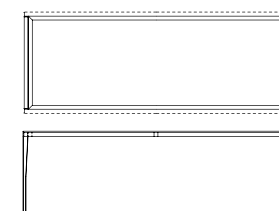

Art. TLA 200  
L/W 200 H 74 P/D 92  
W 78.7" H 29.1" D 36.2"

Art. TLA 240  
L/W 240 H 74 P/D 100  
W 94.5" H 29.1" D 39.4"

Art. TLA 300  
L/W 300 H 74 P/D 110  
W 118.1" H 29.1" D 43.3"

# Board

tavolo / table

Pagina\_Page 198

Tavolo. Struttura in legno laccato o in rovere finitura termo-trattato o verniciato a poro aperto. Piano in pietra acrilica S28 white o in marmo.

Table. Frame in lacquered wood or in oak, heat-treated or open pore painted. Top in S28 white acrylic stone or in marble.

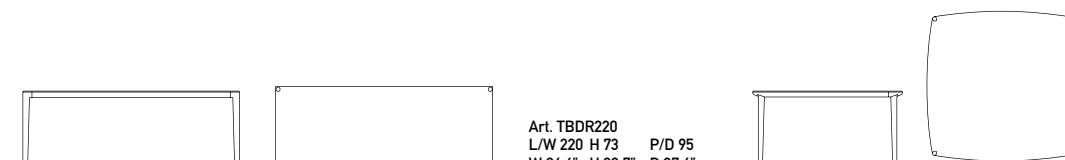

Art. TBDR220  
L/W 220 H 73 P/D 95  
W 86.6" H 28.7" D 37.4"

Art. TBD150  
L/W 150 H 73 P/D 150  
W 59" H 28.7" D 59"

## Liuto

tavolo / table

Pagina\_Page 40-50 - 86

Tavolo. Gambe in pressofusione di alluminio cromato, verniciato o nickel nero. Piano in cristallo fumé temperato spessore 12 mm., rovere termotrattato a spicchi, Noce "Nazionale", MDF laccato opaco o in cemento spatolato\*.

Table. Legs in chrome-plated or painted die-cast aluminium or in black nickel. Top in smoke-grey tempered glass 12 mm. thick, heat-treated oak in segments, Italian walnut, matt lacquered MDF or spatulated concrete\*.

Art. TLUQ 150  
L/W 150 H 74 P/D 150  
W 59" H 29.1" D 59"

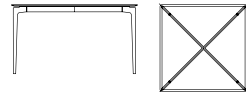

Tavolo. Gambe in pressofusione di alluminio cromato, verniciato o nickel nero. Piano in cristallo fumé temperato spessore 12 mm., rovere termotrattato a spicchi, Noce "Nazionale", MDF laccato opaco o in cemento spatolato\*. Piano disponibile anche in marmo.

Table. Legs in chrome-plated or painted die-cast aluminium or in black nickel. Top in smoke-grey tempered glass 12 mm. thick, heat-treated oak in segments, Italian walnut, matt lacquered MDF or spatulated concrete\*. Top available also in marble.

Art. TLUR 135  
Ø 135 H 74  
Ø 53.1" H 29.1"

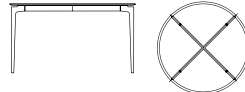

Tavolo. Gambe in pressofusione di alluminio cromato, verniciato o nickel nero. Piano in marmo, cristallo fumé temperato spessore 12 mm., rovere termotrattato a spicchi, Noce "Nazionale", MDF laccato opaco o in cemento spatolato\*.

Table. Legs in chrome-plated or painted die-cast aluminium or in black nickel. Top in marble, in smoke-grey tempered glass 12 mm. thick, heat-treated oak in segments, Italian walnut, matt lacquered MDF or spatulated concrete\*.

Art. TLURT 200  
L/W 200 H 74 P/D 90  
W 78.7" H 29.1" D 35.4"



Art. TLURT 220  
L/W 220 H 74 P/D 90  
W 86.6" H 29.1" D 35.4"

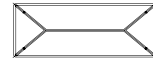

Art. TLURT 260  
L/W 260 H 74 P/D 95  
W 102.4" H 29.1" D 37.4"

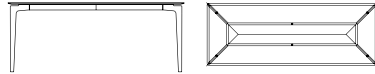

Art. TLURT 300  
L/W 300 H 74 P/D 100  
W 118.1" H 29.1" D 39.4"

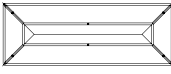

Tavolo. Gambe in pressofusione di alluminio cromato, verniciato o nickel nero. Piano in cristallo fumé temperato spessore 12 mm., rovere termotrattato a spicchi, Noce "Nazionale", MDF laccato opaco o in cemento spatolato\*.

Table. Legs in chrome-plated or painted die-cast aluminium or in black nickel. Top in marble, in smoke-grey tempered glass 12 mm. thick, heat-treated oak in segments, Italian walnut, matt lacquered MDF or spatulated concrete\*.

## Wing chair

sedia / chair

Pagina\_Page 342

### Art. SW1

Sedia. Seduta e spalliera in schiuma di poliuretano flessibile a freddo rivestito in tessuto, pelle o cavallino. Struttura in pressofusione di alluminio con finiture: alluminio lucido o verniciato.

Chair. Seat and back made of flexible cold shaped polyurethane foam covered in fabric, leather or cow skin. Pressure die-casting aluminium frame with choice of finishes: polished or painted aluminium.

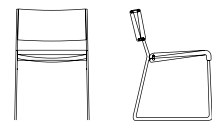

Art. SW1  
L/W 50 H 75 P/D 55  
W 19.7" H 29.5" D 21.6"

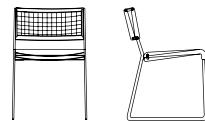

Art. SW2  
L/W 50 H 75 P/D 55  
W 19.7" H 29.5" D 21.6"

### Art. SW2

Sedia. Seduta e spalliera in corda intrecciata colore naturale, nera o bianca. Struttura in pressofusione di alluminio con finiture: alluminio lucido o verniciato.

Chair. Seat and back made of woven cord in natural, black or white colour. Pressure die-casting aluminium frame with choice of finishes: polished or painted aluminium.



## Shine

sedia / chair

Pagina\_Page 204

Sedia. Struttura in metallo rivestita in gomma di poliuretano schiumato a freddo e fodera in fibra di poliestere. Cuscino in gomma poliuretana e dacron. Rivestimento in pelle o tessuto. Gambe in piatto di acciaio cromato o laccato.

Chair. Steel frame covered in cold shaped polyurethane foam and polyester fiber lining. Polyurethane foam and dacron cushion. Fabric or leather covers. Chrome-plated or painted steel plate legs.

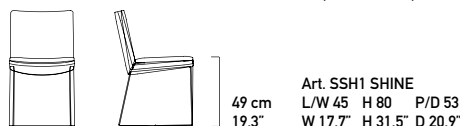

Art. SSH1 SHINE  
L/W 45 H 80 P/D 53  
W 17.7" H 31.5" D 20.9"

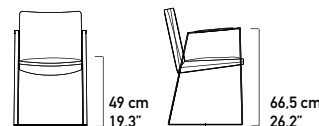

Art. PSH1 SHINE B  
L/W 49.5 H 80 P/D 53  
W 19.5" H 31.5" D 20.9"



## Axia

sedia / chair

Pagina\_Page 268

Sedia. Struttura in tubo di acciaio cromato o laccato. Rivestimento in cuoio.

Chair. Frame in chrome-plated or painted tubular steel. Seat and back in hide.

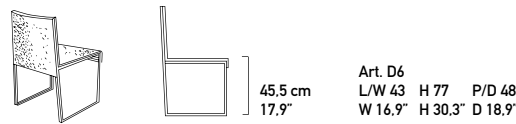

Art. D6  
L/W 43 H 77 P/D 48  
W 16.9" H 30.3" D 18.9"



## Fedra

sedia / chair

Pagina\_Page 178

Sedia. Struttura rivestita in poliuretano schiumato. Rivestimento in pelle o in ecopelle.

Chair. Polyurethane foam padded frame. Leather or synthetic leather covers.

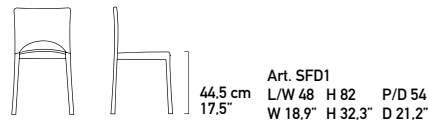

Art. SFD1  
L/W 48 H 82 P/D 54  
W 18.9" H 32.3" D 21.2"



## Denise

sedia / chair

Pagina\_Page 44

Poltroncina. Gambe in fusione di alluminio verniciato, cromato o nickel nero. Struttura in acciaio rivestita in schiuma di poliuretano flessibile a freddo, classe 1M, con fodera in fibra di poliestere. Cuscino seduta in gomma e Dacron. Rivestimento in pelle o in tessuto.

Armchair. Legs in painted or in chrome-plated die-cast aluminium or black nickel. Steel frame upholstered in cold shaped polyurethane foam, class 1M, with polyester fiber lining. Seat cushion in foam and Dacron. Leather or fabric covers.

Poltroncina. Base girevole in acciaio laccato o cromato. Struttura in acciaio rivestita in schiuma di poliuretano flessibile a freddo, classe 1M, con fodera in fibra di poliestere. Cuscino seduta in gomma e Dacron. Rivestimento in pelle o tessuto.

Armchair. Swivel base in painted or chrome-plated steel. Steel frame upholstered in cold shaped polyurethane foam, class 1M, with polyester fiber lining. Seat cushion in foam and Dacron. Leather or fabric covers.

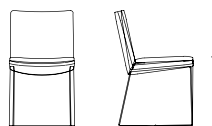

49 cm  
19.3"

Art. SSH1 SHINE  
L/W 45 H 80 P/D 53  
W 17.7" H 31.5" D 20.9"

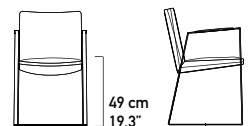

49 cm  
19.3"

66.5 cm  
26.2"

Art. PSH1 SHINE B  
L/W 49.5 H 80 P/D 53  
W 19.5" H 31.5" D 20.9"

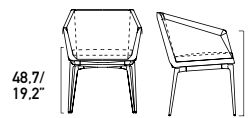

48.7/  
19.2"

65.6/  
25.8"

Art. PDN1  
L/W 60 H 80.5 P/D 59.6  
W 23.6" H 31.7" D 23.5"

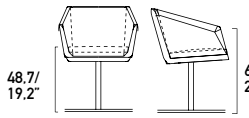

48.7/  
19.2"

65.6/  
25.8"

Art. PDN2  
L/W 60 H 77 P/D 59.6  
W 23.6" H 30.3" D 23.5"

## Bohème

letto / bed

Pagina\_Page 60

Letto. Base in massello di rovere verniciato, con giroletto superiore rivestito in pelle o tessuto, o in massello di legno totalmente rivestito in pelle. Testata in legno imbottita in gomma poliuretana e fodera in fibra di poliestere. Rivestimento in pelle o tessuto trapuntato. Rete con doghe di faggio.

Bed. Base in stained massive oak, with upholstered bed edge covered in leather or in fabric, or in massive wood fully covered in leather. Headboard made of wood upholstered with polyurethane foam and polyester fiber lining. Quilted cover in leather or fabric. Beechwood bed slats.

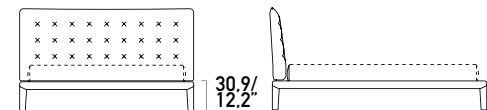

Art. LBH1S STANDARD  
L/W 181 H 106 P/D 223  
W 71.3" H 41.7" D 87.8"

Art. LBH1Q QUEEN SIZE  
L/W 171 H 106 /D 226  
W 67.3" H 41.7" D 89"

Art. LBH1K KING SIZE  
L/W 214 H 106 P/D 226  
W 84.2" H 41.7" D 89"

Art. LBH1E EUROPE  
L/W 201 H 106 P/D 223  
W 79.1" H 41.7" D 87.8"

Per materasso / For mattress  
L/W 160 P/D 200  
W 63" D 78.7"

Per materasso / For mattress  
L/W 150 P/D 203  
W 59" D 79.9"

Per materasso / For mattress  
L/W 193 P/D 203  
W 76" D 79.9"

Per materasso / For mattress  
L/W 180 P/D 200  
W 70.9" D 78.7"

## Suite

letto / bed

Pagina\_Page 98

Letto. Testata in legno rivestita in gomma poliuretana e piuma sterilizzata. Piedi in pressofusione di alluminio. Rivestimento in pelle o tessuto. Rete con doghe di faggio.

Bed. Headboard in wood covered in polyurethane foam and sterilized feathers. Die-cast aluminium feet. Leather or fabric cover. Beechwood slats.

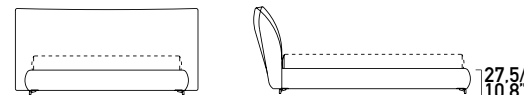

Art. LSU1S STANDARD  
L/W 203 H 95 P/D 243  
W 79.9" H 37.4" D 95.7"

Art. LSU1Q QUEEN SIZE  
L/W 193 H 95 /D 249  
W 76" H 37.4" D 98"

Art. LSU1K KING SIZE  
L/W 233 H 95 P/D 249  
W 91.7" H 37.4" D 98"

Art. LSU1E EUROPE  
L/W 223 H 95 P/D 246  
W 87.8" H 37.4" D 96.8"

Per materasso / For mattress  
L/W 160 P/D 200  
W 63" D 78.7"

Per materasso / For mattress  
L/W 150 P/D 203  
W 59" D 79.9"

Per materasso / For mattress  
L/W 193 P/D 203  
W 76" D 79.9"

Per materasso / For mattress  
L/W 180 P/D 200  
W 70.9" D 78.7"

## Arca

letto / bed

Pagina\_Page 128

Letto. Testata in legno rivestita in poliuretano e Dacron con fodera in fibra di poliestere. Base in legno rivestita in poliuretano. Gambe in acciaio verniciato. Rivestimento in pelle o tessuto. Rete con doghe di faggio.

Bed. Headboard covered in polyurethane foam and Dacron with polyester fiber lining. Wooden base covered in polyurethane foam. Legs in painted steel. Leather or fabric cover. Beechwood bed slats.

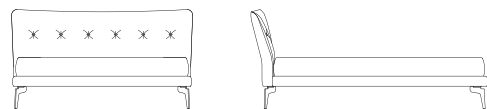

Art. LRC 1S STANDARD  
L/W 170 H 93 P/D 220  
W 66.9" H 36.6" D 86.6"

Art. LRC 1Q QUEEN SIZE  
L/W 160 H 93 /D 223  
W 63" H 36.6" D 87.8"

Art. LRC 1K KING SIZE  
L/W 203 H 93 P/D 223  
W 80" H 36.6" D 87.8"

Art. LRC 1E EUROPE  
L/W 190 H 93 P/D 220  
W 74.8" H 36.6" D 86.6"

Per materasso / For mattress  
L/W 150 P/D 200  
W 63" D 78.7"

Per materasso / For mattress  
L/W 150 P/D 203  
W 59" D 79.9"

Per materasso / For mattress  
L/W 193 P/D 203  
W 76" D 79.9"

Per materasso / For mattress  
L/W 180 P/D 200  
W 70.9" D 78.7"

## Maya

letto / bed

Pagina\_Page 180

Letto. Testata rivestita in gomma poliuretana e fodera in fibra acrilica. Base in acciaio con giroletto rivestito in gomma poliuretana e fibra acrilica. Cornice in estruso di alluminio e piedi in pressofusione di alluminio, finitura brillantato o laccato. Rivestimento in pelle o tessuto. Rete con doghe di faggio.

Bed. Headboard covered in polyurethane foam and acrylic fiber lining. Steel base and frame covered in polyurethane foam and acrylic fiber. Aluminum section frame and die- cast aluminum feet, both polished or painted. Leather or fabric cover. Beechwood bed slats.



Art. LM1S STANDARD  
L/W 190 H 88 P/D 224  
W 74.8" H 34.6" D 88.2"

Art. LM1Q QUEEN SIZE  
L/W 180 H 88 P/D 230  
W 70.9" H 34.6" D 90.6"

Art. LM1K KING SIZE  
L/W 223 H 88 P/D 230  
W 87.8" H 34.6" D 90.6"

Art. LM1E EUROPE  
L/W 210 H 88 P/D 227  
W 82.7" H 34.6" D 89.4"

Per materasso / For mattress  
L/W 160 P/D 200  
W 63" D 78.7"

Per materasso / For mattress  
L/W 150 P/D 203  
W 59" D 79.9"

Per materasso / For mattress  
L/W 193 P/D 203  
W 76" D 79.9"

Per materasso / For mattress  
L/W 180 P/D 200  
W 70.9" D 78.7"

## Oasi/Oasi plus

letto / bed letto con contenitore / bed with storage base

Pagina\_Page 208

Letto. Testata in acciaio rivestita in schiuma di poliuretano flessibile a freddo. Cuscini testata in piuma sterilizzata. Rivestimento in pelle o tessuto. Sommier in legno rivestito in gomma poliuretana e dacron. Rete con doghe di faggio. Piedi in pressofusione di alluminio lucido o laccato.

Bed. Flexible cold shaped polyurethane foam padded steel headboard. Sterilized feather cushions. Fabric or leather upholstery. Wooden box spring with polyurethane foam and polyester padding. Beechwood slats. Die-cast polished or lacquered aluminium feet.

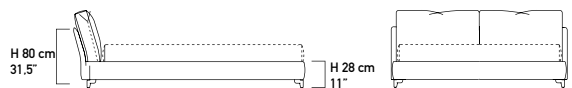

OASI

Art. LOAS STANDARD  
L/W 174 H 80 P/D 226  
L/W 68.5" H 31.5" D 89"

Art. LOAQ QUEEN SIZE  
L/W 164 H 80 P/D 232  
L/W 64.6" H 31.5" D 91.3"

Art. LOAK KING SIZE  
L/W 207 H 80 P/D 232  
L/W 81.5" H 31.5" D 91.3"

Art. LOAE EUROPE  
L/W 196 H 80 P/D 229  
L/W 77.2" H 31.5" D 90.2"



OASI PLUS

Art. LOA2S STANDARD  
L/W 174 H 80 P/D 226  
L/W 68.5" H 31.5" D 89"

Art. LOA2Q QUEEN SIZE  
L/W 164 H 80 P/D 232  
L/W 64.6" H 31.5" D 91.3"

Art. LOA2K KING SIZE  
L/W 207 H 80 P/D 232  
L/W 81.5" H 31.5" D 91.3"

Art. LOA2E EUROPE  
L/W 196 H 80 P/D 229  
L/W 77.2" H 31.5" D 90.2"

Per materasso / For mattress  
L/W 160 P/D 197  
L/W 63" D 77.6"

Per materasso / For mattress  
L/W 150 P/D 203  
L/W 59" D 79.9"

Per materasso / For mattress  
L/W 193 P/D 203  
L/W 76" D 79.9"

Per materasso / For mattress  
L/W 180 P/D 200  
L/W 70.9" D 78.7"

## Join

letto / bed

Pagina\_Page 228

Letto. Base in massello di rovere finitura "termo-trattato" o verniciato o in massello di legno laccato opaco. Testata imbottita con rivestimento in pelle o tessuto. Rete con doghe di faggio.

Bed. Base in "heat-treated" massive oak, stained or in matt lacquered massive wood. Upholstered headboard with leather or fabric covers. Beechwood slats.

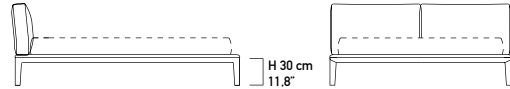

Art. LJS / STANDARD  
L/W 180 H 81 P/D 230  
L/W 70.9" H 31.9" D 90.6"

Art. LJQ / QUEEN SIZE  
L/W 170 H 81 P/D 233  
L/W 66.9" H 31.9" D 91.7"

Art. LJK / KING SIZE  
L/W 213 H 81 P/D 233  
L/W 83.8" H 31.9" D 91.7"

Art. LJE / EUROPE  
L/W 200 H 81 P/D 230  
L/W 78.7" H 31.9" D 90.6"

Per materasso / For mattress  
L/W 160 P/D 197  
L/W 63" D 77.6"

Per materasso / For mattress  
L/W 150 P/D 203  
L/W 59" 79.9"

Per materasso / For mattress  
L/W 193 P/D 203  
L/W 76" D 79.9"

Per materasso / For mattress  
L/W 180 P/D 200  
L/W 70.9" D 78.7"



## Blade/A

letto / bed

Pagina\_Page 278

Letto. Gambe e cornice testata in acciaio cromato o laccato. Testata e giroletto imbottiti in gomma poliuretana e Dacron. Rivestimento in pelle o tessuto. Rete con doghe di faggio.

Bed. Legs and the headboard frame in chrome-plated or painted steel. Headboard and sides covered with polyurethane foam and Dacron. Leather or fabric covers. Bed slats in beech wood.

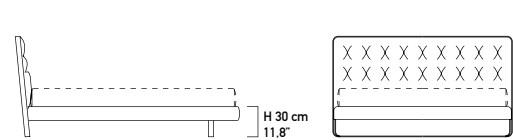

Art. LBB2S STANDARD  
L/W 172 H 95 P/D 215  
L/W 67.7" H 37.4" D 84.6"

Per materasso / For mattress  
L/W 160 P/D 197  
L/W 63" D 77.5"

Art. LBB2Q QUEEN SIZE  
L/W 162 H 95 P/D 221  
L/W 63.8" H 37.4" D 87"

Per materasso / For mattress  
L/W 150 P/D 203  
L/W 59" D 79.9"

Art. LBB2K KING SIZE  
L/W 205 H 95 P/D 221  
L/W 80.7" H 37.4" D 87"

Per materasso / For mattress  
L/W 193 P/D 203  
L/W 76" D 79.9"

Art. LBB2E EUROPE  
L/W 192 H 95 P/D 218  
L/W 75.6" H 37.4" D 85.8"

Per materasso / For mattress  
L/W 180 P/D 200  
L/W 70.9" D 78.7"



## Blade/B

letto / bed

Pagina\_Page 280

Letto. Gambe e cornice testata in acciaio cromato o laccato. Testata e giroletto imbottiti in gomma poliuretana e Dacron. Rivestimento in pelle o tessuto. Rete con doghe di faggio.

Bed. Legs and the headboard frame in chrome-plated or painted steel. Headboard and sides covered with polyurethane foam and Dacron. Leather or fabric covers. Bed slats in beech wood.

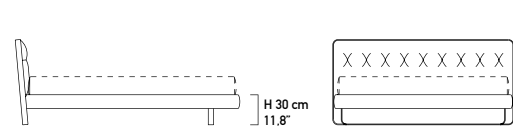

Art. LBB1S / STANDARD  
L/W 172 H 84 P/D 215  
L/W 67.7" H 33" D 84.6"

Per materasso / For mattress  
L/W 160 P/D 197  
L/W 63" D 77.5"

Art. LBB1Q / QUEEN SIZE  
L/W 162 H 84 P/D 221  
L/W 63.8" H 33" D 87"

Per materasso / For mattress  
L/W 150 P/D 203  
L/W 59" D 79.9"

Art. LBB1K / KING SIZE  
L/W 205 H 84 P/D 221  
L/W 80.7" H 33" D 87"

Per materasso / For mattress  
L/W 193 P/D 203  
L/W 76" D 79.9"

Art. LBB1E / EUROPE  
L/W 192 H 84 P/D 218  
L/W 75.6" H 33" D 85.8"

Per materasso / For mattress  
L/W 180 P/D 200  
L/W 70.9" D 78.7"



## Echo

letto / bed

Pagina\_Page 344

Letto. Testata in legno rivestita in poliuretano e piuma d'oca sterilizzata. Base in legno rivestita in poliuretano. Rivestimento in pelle o tessuto. Gambe in acciaio cromato. Rete con doghe in faggio. Disponibile anche con cornice cromata (Art. LS1).

Bed. Headboard made of wood upholstered with polyurethane foam and sterilized feathers. Wooden edge upholstered with polyurethane foam. Leather or fabric covers. Legs made of chrome-plated steel. Beechwood slats. Available also with chrome-plated edge (Art. LS1).

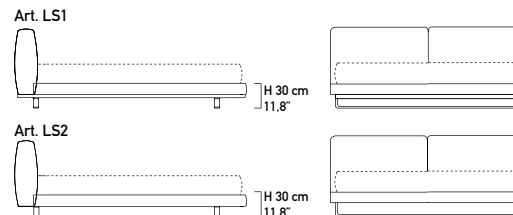

Art. LS1S / Art. LS2S / STANDARD  
L/W 182 H 81 P/D 226  
L/W 71.6" H 31.9" D 89"

Per materasso / For mattress  
L/W 170 P/D 197  
L/W 66.9" D 77.5"

Art. LS1Q / Art. LS2Q / QUEEN SIZE  
L/W 172 H 81 P/D 232  
L/W 67.7" H 31.9" D 91.3"

Per materasso / For mattress  
L/W 150 P/D 203  
L/W 59" D 79.9"

Art. LS1K / Art. LS2K / KING SIZE  
L/W 204 H 81 P/D 232  
L/W 80.3" H 31.9" D 91.3"

Per materasso / For mattress  
L/W 193 P/D 203  
L/W 76" D 79.9"

Art. LS1E / Art. LS2E / EUROPE  
L/W 192 H 81 P/D 229  
L/W 75.6" H 31.9" D 90.1"

Per materasso / For mattress  
L/W 180 P/D 200  
L/W 70.9" D 78.7"



## Kendo

letto / bed

Pagina\_Page 314

Letto. Struttura in acciaio imbottita in gomma poliuretana e Dacron. Rivestimento in pelle o tessuto. Base in acciaio cromato o verniciato. Rete con doghe di faggio.

Bed. Steel frame upholstered with polyurethane foam and Dacron. Leather or fabric covers. Steel basement, chrome-plated or painted. Beechwood slats.

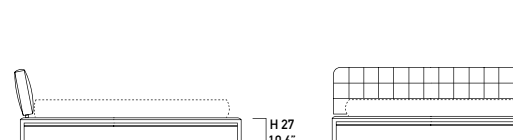

Art. LK1S / STANDARD  
L/W 190 H 75 P/D 224  
L/W 74.8" H 29.5" D 88.2"

Per materasso / For mattress  
L/W 160 P/D 197  
L/W 63" D 77.5"

Art. LK1Q / QUEEN SIZE  
L/W 180 H 75 P/D 230  
L/W 70.9" H 29.5" D 90.6"

Per materasso / For mattress  
L/W 150 P/D 203  
L/W 59" D 79.9"

Art. LK1K / KING SIZE  
L/W 223 H 75 P/D 230  
L/W 87.8" H 29.5" D 90.6"

Per materasso / For mattress  
L/W 193 P/D 203  
L/W 76" D 79.9"

Art. LK1E / EUROPE  
L/W 210 H 75 P/D 227  
L/W 82.7" H 29.5" D 89.4"

Per materasso / For mattress  
L/W 180 P/D 200  
L/W 70.9" D 78.7"



## Feng

letto / bed

Pagina\_Page 320

Letto. Struttura in acciaio imbottita in gomma poliuretana e dacron. Rivestimento in pelle o tessuto. Basamento in alluminio satinato. Rete con doghe di faggio.

Bed. Steel frame upholstered with polyurethane foam and dacron. Leather or fabric covers. Satin aluminium basement. Beechwood slats.

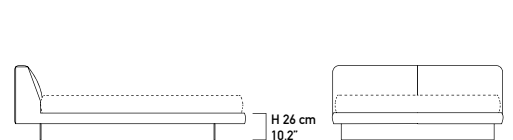

Art. LF 1S / STANDARD  
L/W 170 H 73 P/D 222  
L/W 66.9" H 28.7" D 87.4"

Per materasso / For mattress  
L/W 160 P/D 197  
L/W 63" D 77.5"

Art. LF 1Q / QUEEN SIZE  
L/W 160 H 73 P/D 228  
L/W 63" H 28.7" D 89.8"

Per materasso / For mattress  
L/W 150 P/D 203  
L/W 59" D 79.9"

Art. LF 1K / KING SIZE  
L/W 203 H 73 P/D 228  
L/W 79.9" H 28.7" D 89.8"

Per materasso / For mattress  
L/W 193 P/D 203  
L/W 76" D 79.9"

Art. LF 1E / EUROPE  
L/W 190 H 73 P/D 225  
L/W 74.8" H 28.7" D 88.6"

Per materasso / For mattress  
L/W 180 P/D 200  
L/W 70.9" D 78.7"



## Plaza

letto / bed

Pagina\_Page 376

Letto. Base in MDF laccato lucido o opaco. Testata imbottita in gomma poliuretana e fodere in fibra acrilica. Rivestimento in pelle o tessuto. Rete con doghe in faggio. Disponibile anche con comodini con cassetto (Art. LP1C).

Bed. Basement in MDF glossy or matt lacquered. Upholstered headboard in polyurethane foam and acrylic fiber lining. Leather or fabric covers. Beechwood slats. Available also with side tables with drawer (Art. LP1C).

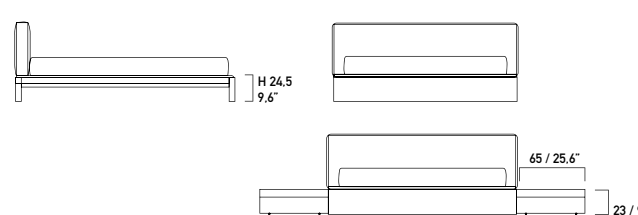

Art. LP1S / Standard  
L/W 182 H 76.5 P/D 217  
L/W 71.6" H 30.1" D 85.4"

Per materasso / For mattress  
L/W 160 P/D 197  
L/W 63" D 77.5"

Art. LP1C  
Letto con comodini.  
Bed with side tables.

Art. LP1Q / Queen Size  
L/W 172 H 76.5 P/D 223  
L/W 67.7" H 30.1" D 87.8"

Per materasso / For mattress  
L/W 150 P/D 203  
L/W 59" D 79.9"

Comodino. Side table.  
L/W 65 H 23 P/D 50  
W 25.6" H 9.1" D 19.7"

Art. LP1K / King Size  
L/W 215 H 76.5 P/D 223  
L/W 84.6" H 30.1" D 87.8"

Per materasso / For mattress  
L/W 193 P/D 203  
L/W 76" D 79.9"

Art. LP1E / Europe  
L/W 202 H 76.5 P/D 220  
L/W 79.5" H 30.1" D 86.6"

Per materasso / For mattress  
L/W 180 P/D 200  
L/W 70.9" D 78.7"



# Skin

complementi notte / bedroom complements

Pagina\_Page 68



Comò, settimanale e comodino in rovere termotrattato o in noce "Nazionale" rivestito in cuoio. Piano in cuoio o in marmo.

Settimanale in rovere termotrattato o in noce "Nazionale" rivestito in cuoio, accessori make up e specchio. Piano in cuoio.

Chest of drawers, high chest of drawers and bedside table in heat-treated oak or in Italian walnut covered in hide. Top in hide or in marble.

High chest of drawers in heat-treated oak or in Italian walnut covered in hide, equipped with mirror and make-up accessories. Top in hide.

Comò.  
Chest of drawers.

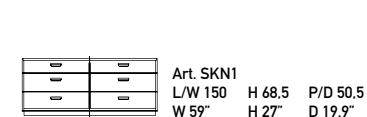

Art. SKN1  
L/W 150 H 68,5 P/D 50,5  
W 59" H 27" D 19,9"

Settimanale.  
High chest of drawers.

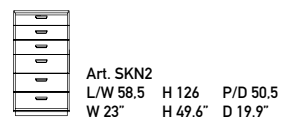

Art. SKN2  
L/W 58,5 H 126 P/D 50,5  
W 23" H 49,6" D 19,9"

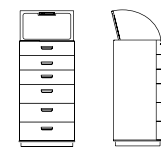

Art. SKN2A  
L/W 58,5 H 126 P/D 50,5  
W 23" H 49,6" D 19,9"

Comodino.  
Bedside table.



Art. SKN3  
L/W 45 H 48 P/D 43  
W 17,7" H 18,9" D 16,9"



Art. SKN4  
L/W 65 H 36,5 P/D 43  
W 25,6" H 14,4" D 16,9"

# Meridien

complementi notte / bedroom complements

Pagina\_Page 136



Cassettone, settimanale e comodino in MDF laccato opaco o in rovere verniciato o termotrattato. Top e base in acciaio verniciato.

Chest of drawers, high chest of drawers and bedside table in matt lacquered MDF or in painted or heat-treated oak. Top and base in painted steel.

Comodino.  
Bedside table.



Art. SME3  
L/W 46 H 37 P/D 47  
W 26" H 14,6" D 18,5"

Cassettone.  
Chest of drawers.

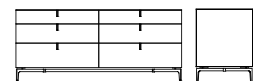

Art. SME1  
L/W 156 H 70 P/D 53  
W 61,4" H 27,6" D 20,9"

Settimanale.  
High chest of drawers.

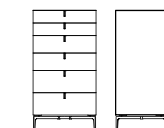

Art. SME2  
L/W 65 H 124 P/D 53  
W 25,6" H 48,8" D 20,9"

# Inside

complementi notte / bedroom complements

Pagina\_Page 102



Comò, settimanale e comodino in MDF laccato opaco. Base in pressofusione di alluminio verniciato o brillantato.

Chest of drawers, high chest of drawers and bedside table in matt lacquered MDF. Base in painted or polished die-cast aluminium.

Comò.  
Chest of drawers.



Art. SIN1  
L/W 155,3 H 71,6 P/D 50,3  
W 61,1" H 28,2" D 19,8"

Settimanale.  
High chest of drawers.

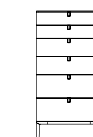

Art. SIN2  
L/W 60,3 H 125,6 P/D 50,3  
W 23,7" H 49,4" D 19,8"

Comodino.  
Bedside table.



Art. SIN3  
L/W 65,3 H 38,7 P/D 47,3  
W 25,7" H 15,2" D 18,6"

# Kube

complementi notte / bedroom complements

Pagina\_Page 232



Comò, settimanale e comodino in rovere termotrattato, verniciato o in MDF laccato opaco. Top in pietra acrilica rivestito in pelle. Maniglie in pelle.

Chest of drawers, high chest of drawers and bedside table in heat-treated or painted oak or matt lacquered MDF. Acrylic stone top covered in leather. Leather handles.

Comò.  
Chest of drawers.

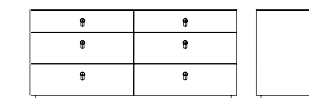

Art. SKU1  
L/W 150 H 66 P/D 54  
W 59" H 26" D 21"

Settimanale.  
High chest of drawers.

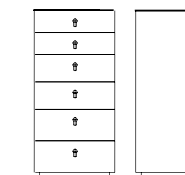

Art. SKU2  
L/W 58 H 122 P/D 48  
W 23" H 48" D 19"

Comodino.  
Bedside table.

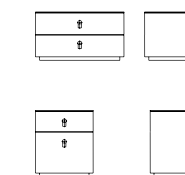

Art. SKU3  
L/W 65 H 35 P/D 46  
W 25" H 14" D 18"



Art. SKU4  
L/W 42 H 48 P/D 42  
W 16" H 19" D 16"

# Edo

complementi notte / bedroom complements

Pagina\_Page 318



Comò, settimanale e comodino in MDF laccato o in rovere. Base in acciaio cromato o laccato.

Chest of drawers, high chest of drawers and bedside table in laquered MDF or in oak. Chrome-plated or painted steel base.

Comò.  
Chest of drawers.

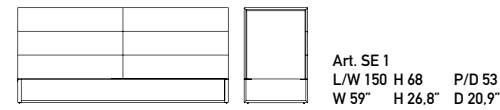

Art. SE 1  
L/W 150 H 68 P/D 53  
W 59" H 26.8" D 20.9"

Settimanale.  
High chest of drawers.

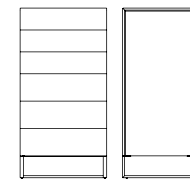

Art. SE 2  
L/W 63 H 124 P/D 53  
W 24.8" H 48.8" D 20.9"

Comodino.  
Bedside table.

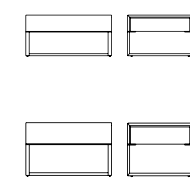

Art. SE 3  
L/W 63 H 32 P/D 48  
W 24.8" H 12.6" D 18.9"

Art. SE 3/B  
L/W 63 H 45 P/D 48  
W 24.8" H 17.7" D 18.9"

# Fjord

complementi notte / bedroom complements

Pagina\_Page 348



Comò, settimanale e comodino. Fianchi in rovere verniciato o in MDF laccato lucido o opaco. Top e cassetti rivestiti in cuoio.

Chest of drawers, high chest of drawers and bedside table. Sides made of painted oak or in glossy or matt lacquered MDF. Clad in hide on top and drawers.

Comò.  
Chest of drawers.



Art. SFJ1  
L/W 158 H 66 P/D 55  
W 62.2" H 26" D 21.6"

Settimanale.  
High chest of drawers.

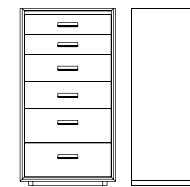

Art. SFJ2  
L/W 67 H 125 P/D 55  
W 26.4" H 49.2" D 21.6"

Comodino.  
Bedside table.

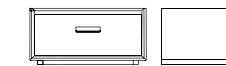

Art. SFJ3  
L/W 67 H 33 P/D 50  
W 26.4" H 13" D 19.7"

# Esprit

complementi notte / bedroom complements

Pagina\_Page 284



Cassettone, settimanale e comodino in MDF laccato lucido o opaco. Base in acciaio cromato o laccato.

Chest of drawers, high chest of drawers and bedside table in glossy or matt lacquered MDF. Chrome-plated or painted steel base.

Comò.  
Chest of drawers.

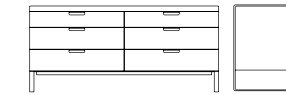

Art. SES 1  
L/W 155 H 70 P/D 53  
W 61" H 27.5" D 20.9"

Settimanale.  
High chest of drawers.

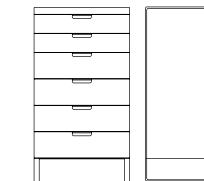

Art. SES 2  
L/W 65 H 119 P/D 53  
W 25.6" H 46.8" D 20.9"

Comodino.  
Bedside table.

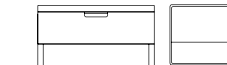

Art. SES 3  
L/W 65 H 34 P/D 48  
W 25.6" H 13.4" D 18.9"

# Frame

complementi notte / bedroom complements

Pagina\_Page 322



Cassettone, settimanale e comodino in MDF laccato lucido o opaco o in rovere. Fianchi in alluminio verniciato.

Chest of drawers, high chest of drawers and bedside table in glossy or matt lacquered MDF or in oak. Sides in painted aluminium.

Comò.  
Chest of drawers.



Art. SF 1  
L/W 144 H 66 P/D 51  
W 56.7" H 26" D 20"

Settimanale.  
High chest of drawers.

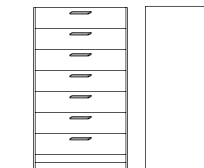

Art. SF 2  
L/W 64 H 124 P/D 51  
W 25.2" H 48.8" D 20"

Comodino.  
Bedside table.

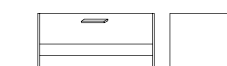

Art. SF 3  
L/W 68 H 28 P/D 48  
W 26.8" H 11" D 18.9"

# ALIVAR in the world

## NORTH AND SOUTH AMERICA

MEXICO  
VENEZUELA  
COLOMBIA  
PERU'

URUGUAY  
Hotel Felytmar

## COSTARICA

USA  
Citibank Offices  
Sony Lobby  
Ann Taylor Shops  
Bergdorf Goodmann  
Barney's New York  
Daniel Day Lewis  
Don Johnson  
Jennifer Lopez

## EUROPE

ITALY  
Gianni Versace Milano  
Aeroporto di Bologna  
Navi Costa Crociere  
Aeroporto di Bolzano  
Pitti Firenze  
Cafè Renault Roma  
Fiera Bolzano  
Comune di Roma  
Banca d'Italia  
Credito Bergamasco  
Hotel Rafael Roma  
Officine Panerai  
Hotel Le Meridien Lingotto Torino  
Banca Antoniana  
A.C. Fiorentina  
Comune di Napoli  
Mada Hotels  
Relax Hotels  
Hotel Michelangelo  
(Chianciano Terme)  
Biblioteca Nazionale di Firenze  
Uffici della Provincia di Latina,  
La Farnesina, Roma  
Ministero dell'Interno, Roma  
Ferretti Group  
Castello di Torregalli, Firenze  
Nun Relais & SPA  
Museum Hotel, Assisi  
Lidl - Uffici Direzionali, Verona  
Hotel Masseria Alchimia, Puglia

Hotel Missoni  
Ristorante Mary & Co, Bormio  
American Express, Roma  
Eni Group, Milano  
Hotel Milano, Bergamo  
Una Hotels & Resort  
Cassa di Risparmio di Firenze  
Università LUISS, Roma  
Harmont & Blaine Spa  
Azimut Benetti Spa  
Divisione Yachtique

THE NEDERLANDS  
W Hotel Amsterdam  
SNC Bank  
Den Bosch Avero Verz. Mij  
Leeuwarden Groene Land Verz.  
Groningen  
De Amersfoortse Verz.  
Amersfoort Psych Centrum  
Zon & Schild  
Bilthoven KPMG Accountancy  
Nieuwegein  
Hotel La Bergère Maastricht

BELGIUM  
Villa Dirickz, Rhode Saint Genese  
Zwart Huiss Knokke

GREECE  
Canaves Hotel Santorini  
Ioniki Bank of Greece  
Interamerican Group  
Nestle Headquarters Athens  
Piraeus Bank Athens

UNITED KINGDOM  
Calvert Gardens Project, Surrey  
Axon Solutions London  
ICAS Edinburgh  
The Park Restaurant London  
Goldman Sachs  
Revlon  
Leaf Bar Manchester  
The Willow Tea Room Glasgow  
The Kensington Hotel London  
London Mel B (Scary Spice)  
Spice Girls  
Spice Cube Restaurant

IRELAND  
Air Lingus

ICELAND  
Radisson sas  
1919 Hotel Reykjavik

CZECH REPUBLIC  
Villa Tugendhat Brno  
Maximilian Hotel Prague  
Sparta Prague F.C.

GERMANY  
Bosch Offices  
ABC Bank Berlin  
Hochtief Niederlassung Bayern

LUXEMBOURG  
WGZ Bank

SPAIN  
Hard Rock Hotel Ibiza  
Park Hyatt Mallorca  
Hotel Valencia Palace, Valencia  
Hotel San Roque, Tenerife  
Caya General de Ahorros  
Granada  
Mallorca Glass House

PORTUGAL  
Hotel Florida, Lisbon

## NORWAY

FRANCE  
One Courchevel Resort  
Le Cheval Blanc Courchevel  
Av. President Wilson Paris

AUSTRIA  
SWITZERLAND  
FINLAND

OCEANIA  
AUSTRALIA  
Bally Shop  
Polo Ralph Lauren  
Deutsche Bank  
Citibank Limited  
Reader's Digest  
Sony Music  
University of Technology of Sidney  
Museum of Applied Arts &  
Sciences  
Telecom Australia Ltd  
Riparian Plaza  
Prospect Electricity Sidney  
Crown Casino Melbourne

NEW ZEALAND  
MAURITIUS  
ASIA\_MIDDLE EST

MAROC  
Residential Villa Casablanca

KUWAIT  
Sheick Abdallah  
Al Salem Cultural Centre

## ISRAEL

CYPRUS  
TURKEY  
UAE

SAUDI ARABIA  
Crowne Plaza Hotel Riyadh  
Happy Land Project

LEBANON  
Credit Commercial de France,  
Beirut

ASIA\_FAR EST  
MALAYSIA  
Musictheque Istana  
Hotel Kuala Lumpur

SINGAPORE  
Rabo Bank  
Government of Singapore  
Guess Boutique  
Siemens

HONG KONG  
Sithe Asia

JAPAN  
Pachinko Tower Tokyo  
Glass House, Hiroshima

TAIWAN  
KOREA  
INDONESIA

Design e coordinamento: Arch. Giuseppe Bavuso / A.D. & Grafica: Rossi & Co. / Foto: Studio indoor / Fotolito: Z13 / Stampa: Grafiche Antiga / Print in Italy 2016

100%  
MADE  
IN ITALY



Alivar si riserva la facoltà di apportare  
modifiche tecniche ai propri prodotti.  
Sono possibili differenze di colore dovute  
dalla tecnica di stampa.

Alivar reserves the right to change its  
products without notice. Printed  
catalogue colours may lightly differ.

# HOME PROJECT

ALIVAR s.r.l. Via Leonardo da Vinci 118/14 - 50028 Tavarnelle Val Di Pesa - Firenze - Italy  
tel. + 39 055 8070115 - fax. + 39 055 8070127 [www.alivar.com](http://www.alivar.com) [alivar@alivar.com](mailto:alivar@alivar.com)