



AREC CI-T21H

Auto-Tracking Camera



CI-T21H

Perfect Combination of an Auto-Tracking Technology and a Compact PTZ Camera



Your Most Committed Follower

During an event, presenter, lecturer or speaker needs to be free to move around in every direction. To ensure professional level of recording, CI-T21H combines Full HD camera with precise auto-tracking, auto-zoom and auto-focus functions, in order to always keep the presenter in close-up.



Professional Video Quality for Various Indoor Scenarios

AREC CI-T21H Auto-Tracking Camera comes with 10x optical zoom, 270° pan and 60° tilt, and Full HD (1920x1080@60fps) video quality, making this camera ideal to fit mid to large sized rooms for any conferences, events, classes, trainings and so on.



Auto-Tracking and Auto-Zoom

AREC CI-T21H Camera utilizes AREC's motion-sensitive and smooth tracking technology, ensuring that presenter is always in close-up, even if that person turns back to the audience or walks back and forth.

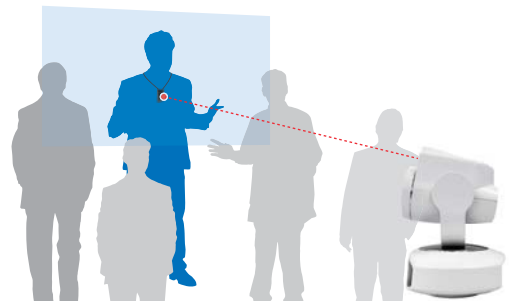

Easy Implementation for Any Type of Indoor Scenario

Combining RJ-45, HDMI and USB outputs, AREC Auto-Tracking Camera can be used with AREC Media Stations for Lecture Capture, any Video Conference System, either HW or SW-based, and even stream to a Live Streaming Service directly.

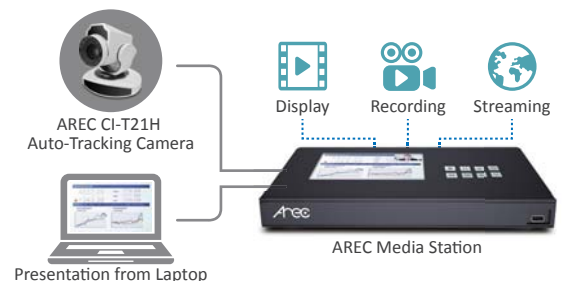

Product View

CI-T21H Front

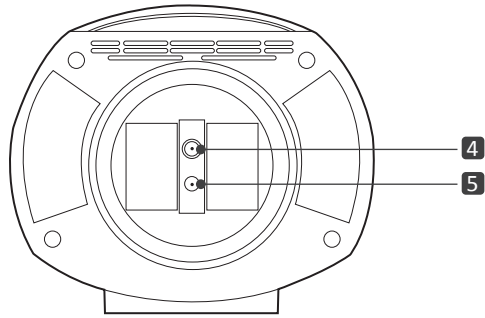
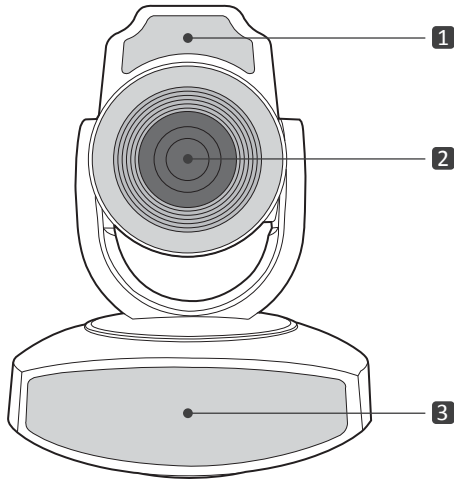

- 1 IR Sensor for Positioner
- 2 Camera lens
- 3 IR Sensor for Remote Controller
- 4 Standard 1/4"20 UNC screw
- 5 Hole for Anti-Rotation Pin

CI-T21H Back

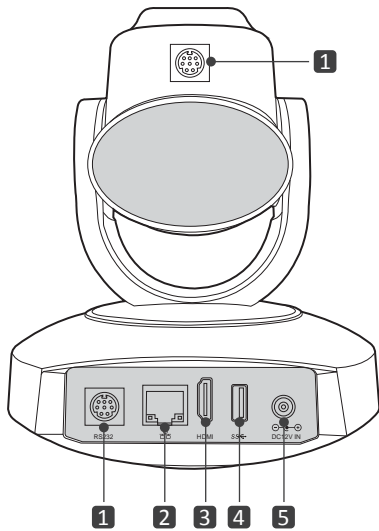

- 1 RS-232 port
- 2 Network Port (RJ-45)
- 3 HDMI Output
- 4 USB3.0 Output
- 5 Power (DC 12V)

AM-600

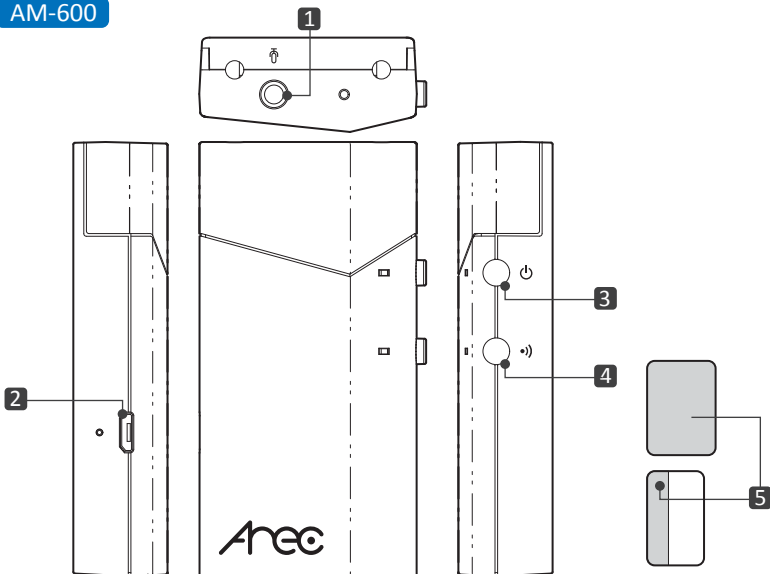

- 1 3.5 audio jack
 - 2 Power (Micro USB port)
 - 3 Button (Power / Tracking On-Off)
 - 4 Button (Microphone Pairing / Mute)*
 - 5 Back-Tracking
- *Only with AREC Media Stations

Remote Controller

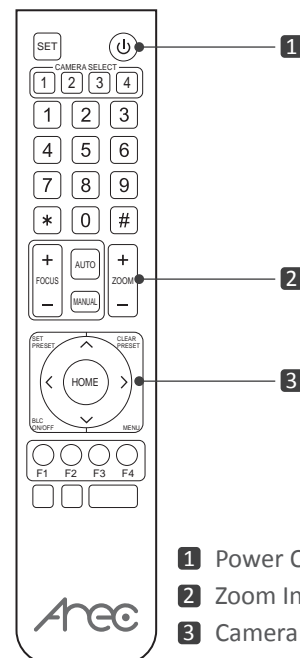

- 1 Power On-Off
- 2 Zoom In/ Zoom Out
- 3 Camera Direction Control

Specification



Model Name	CI-T21H Auto-Tracking Camera
Auto-Tracking Technology	AREC's motion-sensitive and smooth tracking technology
Auto-Tracking Range	Up to 10 m, auto-zoom, auto-focus
Image Sensor	1/2.8" progressive CMOS
Max. Resolution	1920x1080 @ 60fps (IP Streaming) 1920x1080 @ 60fps (HDMI/USB 3.0)
Zoom Ratio	10x optical zoom
Viewing Angle Adjustment	-135°~+135°, -30°~+30°
Minimum Illumination	0.5 lux @ F1.8
Focal Length	4.7 - 47mm
F Number	F1.6 (wide) / F3.0 (tele)
Field of View	60.9° (wide) / 6.43° (tele)
White Balance	Auto / Manual / One Push
Image Enhancement	BLC / WDR / 2D & 3D noise reduction
Video Compression	H.264
Video Output Port	RJ-45, HDMI, USB 3.0
Control Port	RS-232
Control Protocol	VISCA / Pelco-D / Pelco-P
Ethernet Port	RJ-45 connector, 100 Mbps
Network Protocol	RTSP, RTMP, ONVIF
Dimension (L x W x H)	126.7 x 151.2 x 180 mm
Weight	1.1kg
Model Name	AM-600 Positioner
Control Buttons	Power / Tracking On-Off, Microphone Pairing / Mute
Tracking Effective Distance	Working Distance — 2-12m
Microphone Effective Range	12 m. radium (only with AREC Media Stations)
Power Supply	Built-in rechargeable lithium battery
Power Input	Micro-USB
Power Consumption	4 hours, after fully charged
Dimension (L x W x H)	82 x 40 x 18 mm
Weight	70g

AREC Inc. | www.arec.com | sales@arec.com
 Address: 3F, No. 367, Sec.2, Wenhua Rd., Banqiao Dist., New Taipei City 220, Taiwan (R.O.C)
 TEL : +886-2-8259-5060

Exclusive Representative in Europe, Africa and CIS countries
 ADENA Limited | www.a-dena.com
 E-MAIL: yakov@a-dena.com
 TEL: +886-2-2577-7667

AREC reserves the right to modify product specifications without prior notice.