

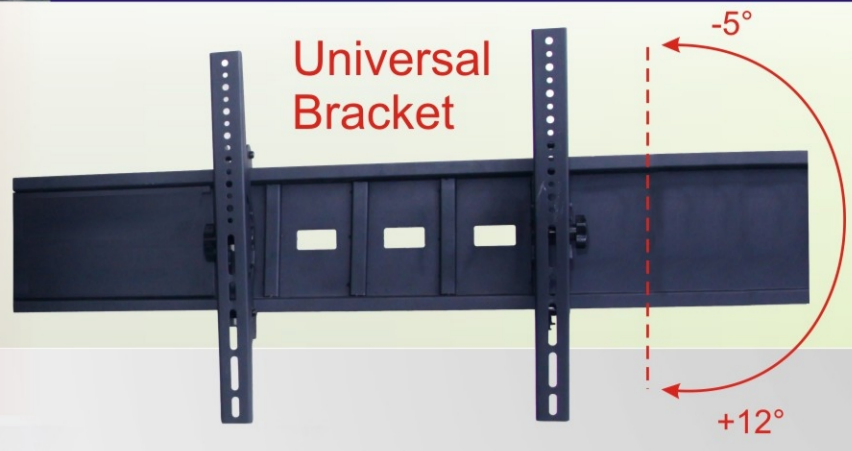

LCD Video Wall Stand



Video Wall Stand 4-Screens

VS-4

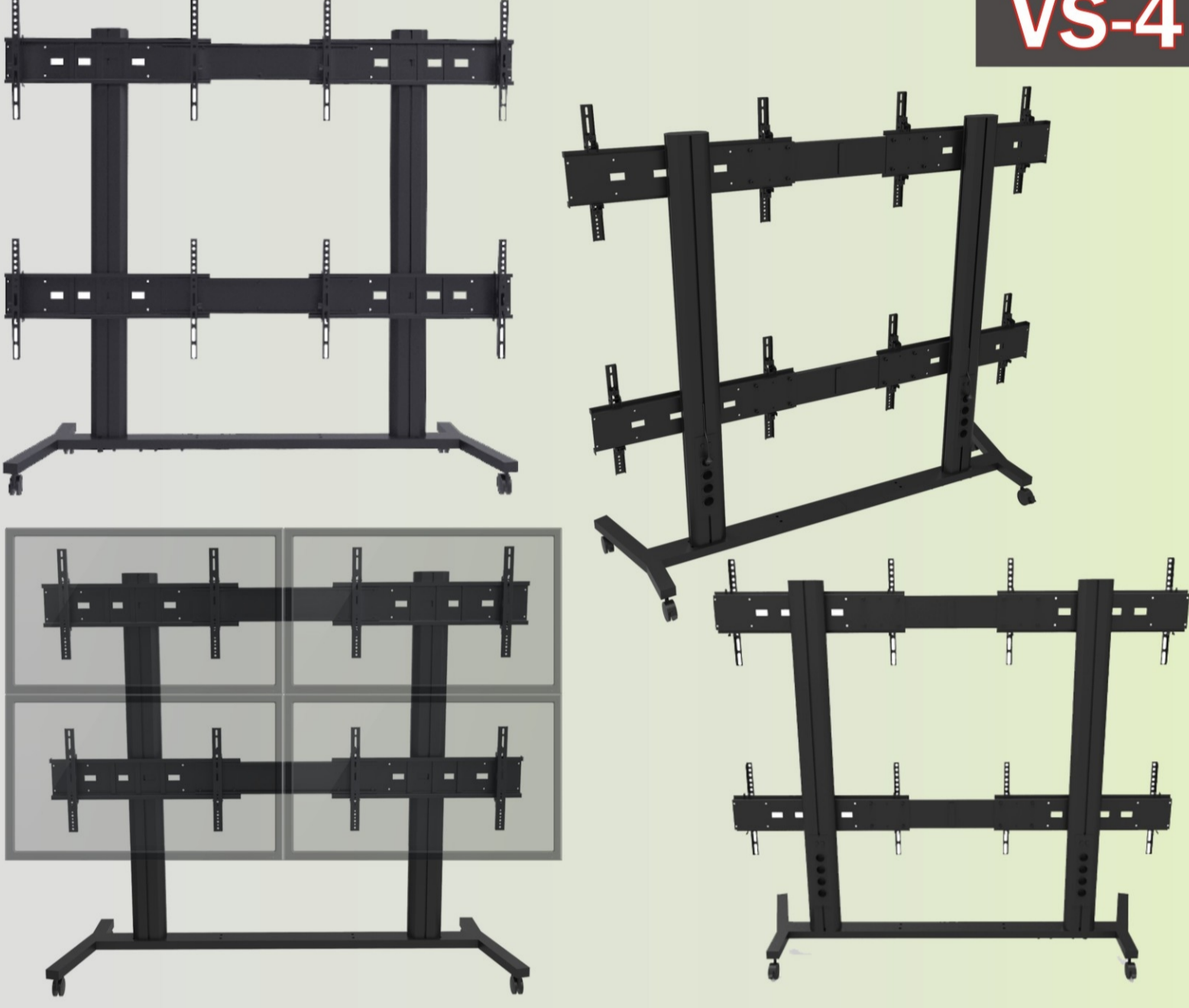

Video Wall Stand 4 Screens (2x2) screen array configuration is: 2 screens wide x 2 screens high.

Video Wall Stand 6-Screens

VS-6

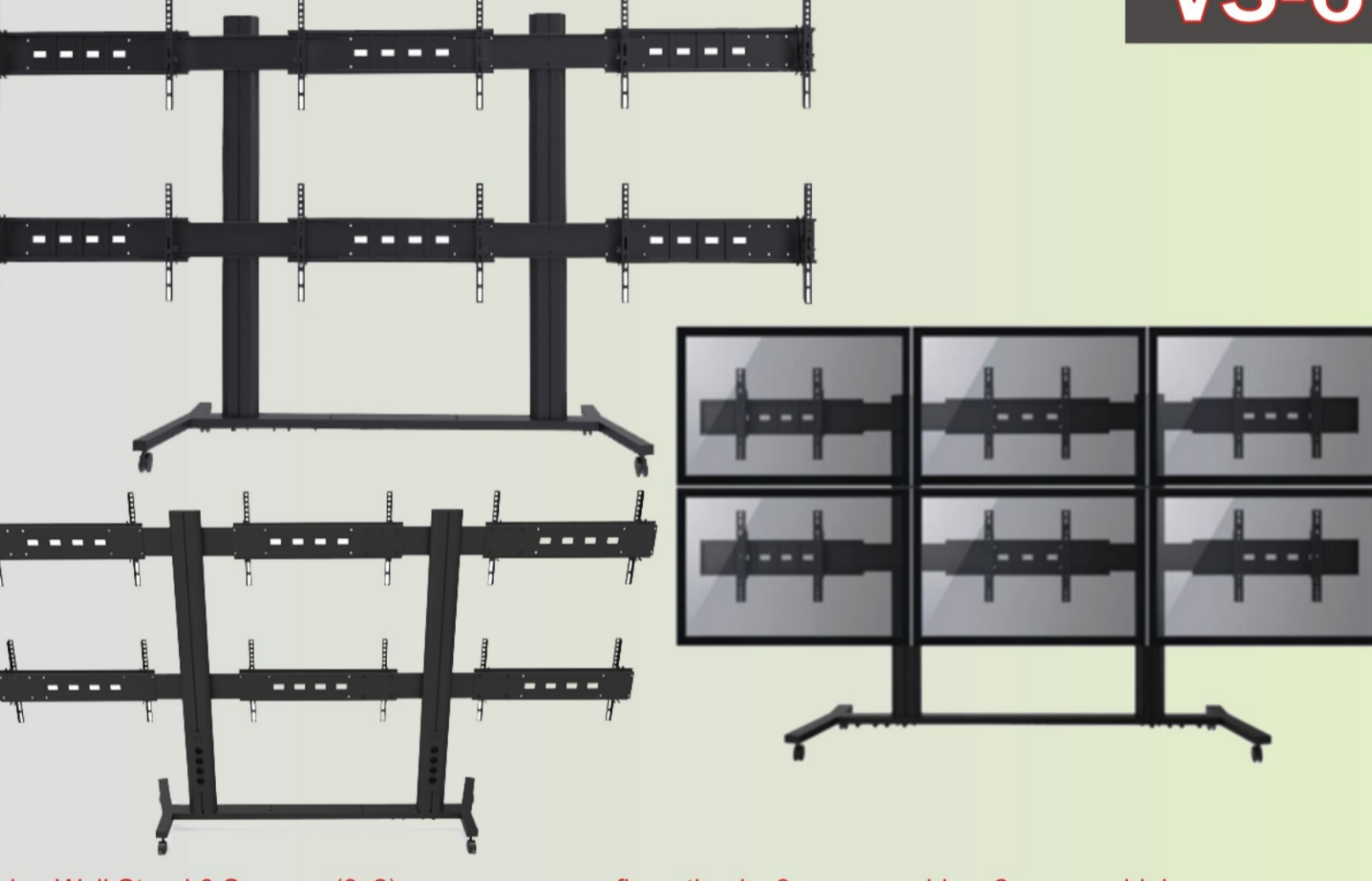

Video Wall Stand 6 Screens (3x2) screen array configuration is: 3 screens wide x 2 screens high.

Video Wall Stand 9-Screens

VS-9

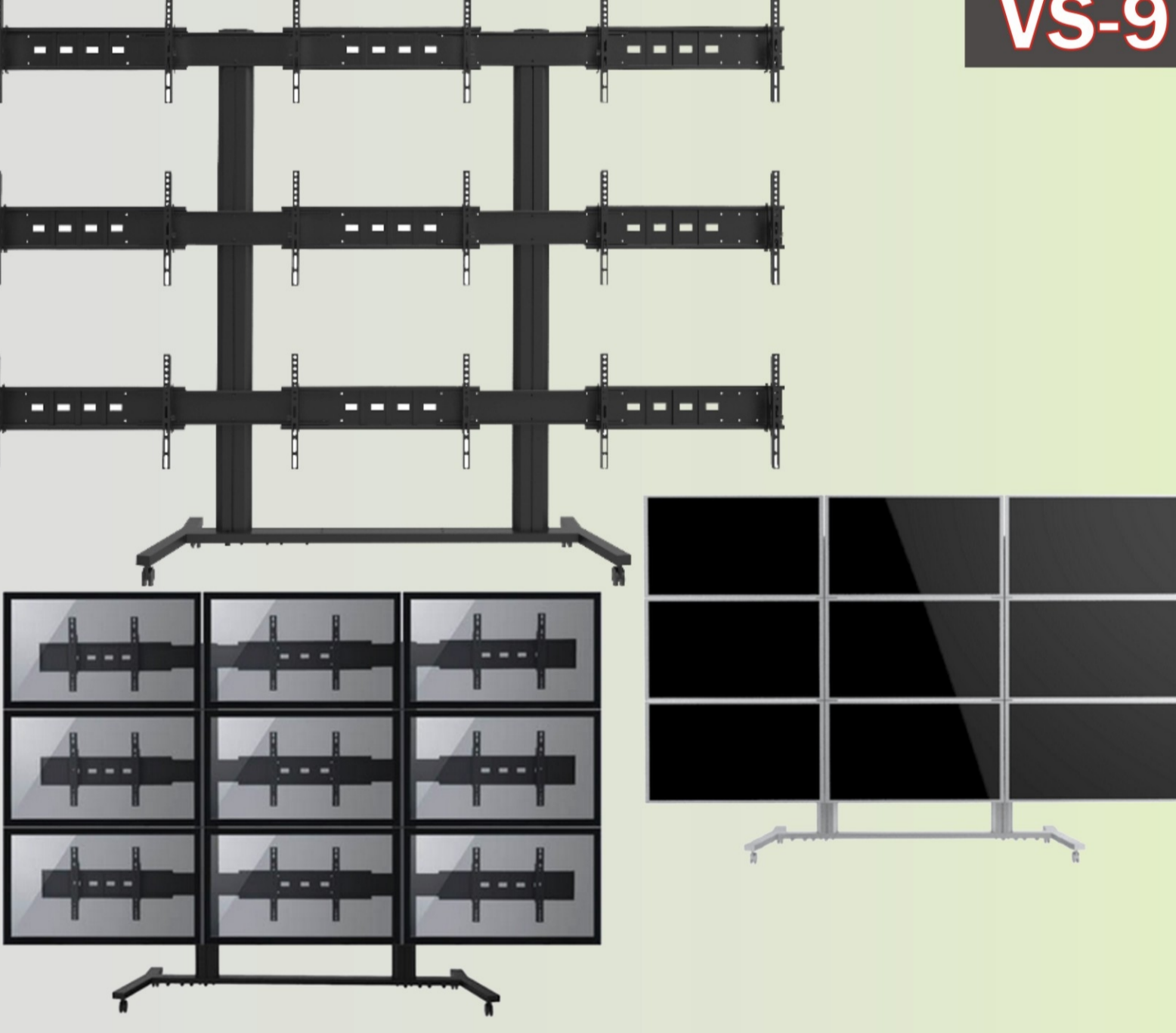

Video Wall Stand 9 Screens (3x3) screen array configuration is: 3 screens wide x 3 screens high.

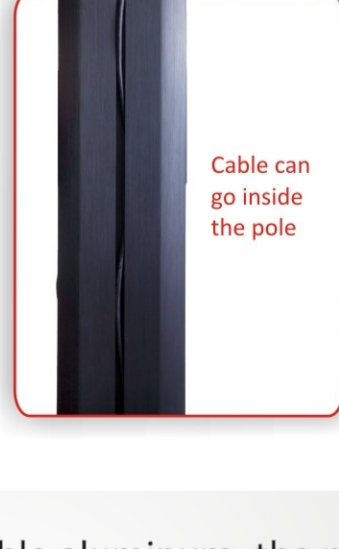
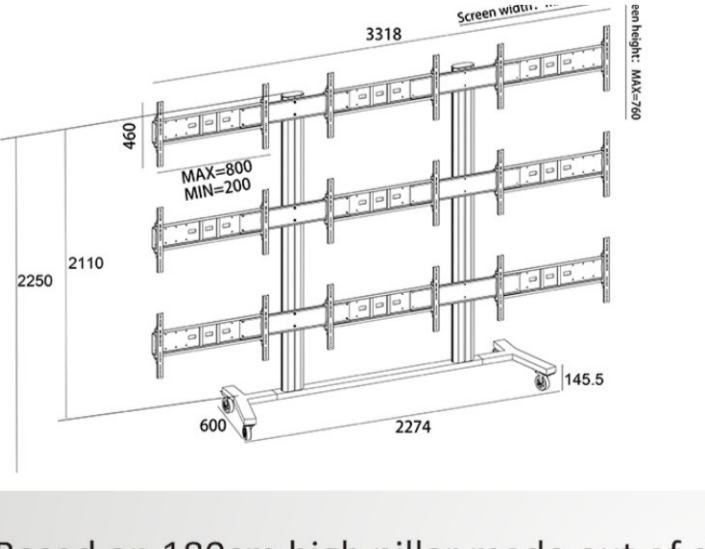
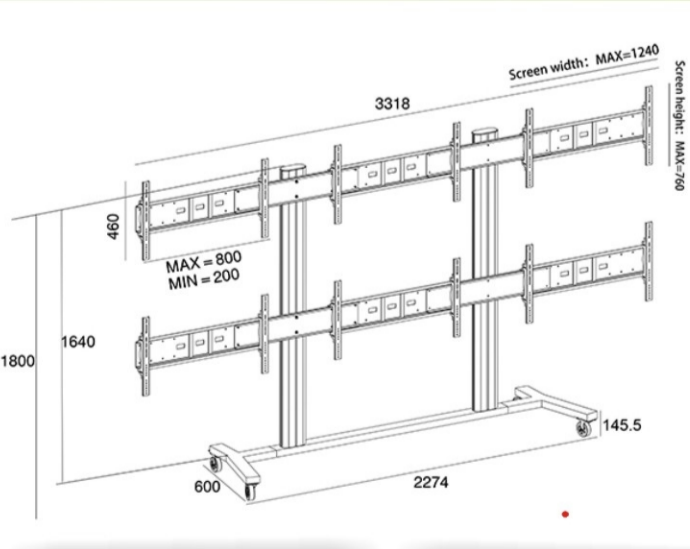
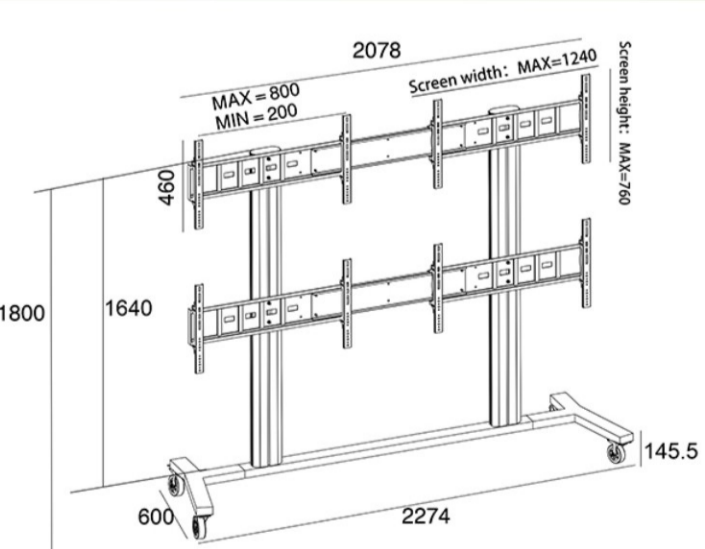

Cable can go inside the pole

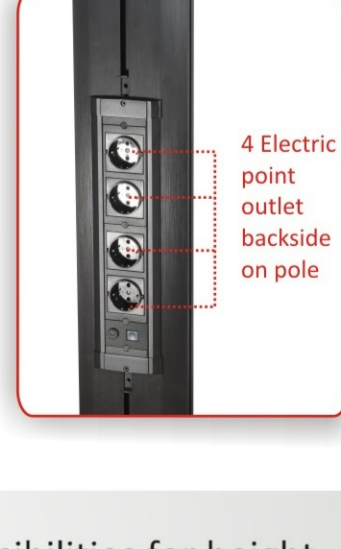

4 Electric point outlet backside on pole

Based on 180cm high pillar made out of durable aluminum, the possibilities for height adjustments are very good and it is possible to provide perfect viewing angle for both a sitting and a standing audience. This movable video wall solution creates a solution that can be used for presentations, trade shows, store or office entrances. This is a perfect solution for customers who need a mobile presentation system for VTC, digital signage applications, and more.

RIFE TECHNOLOGIES

Delhi Office:
362, Vardhman Plaza - II, J-Block, Community Centre, Rajouri Garden, New Delhi - 110027

☎ (011) 2516-7799, 2592-5555
✉ sales@rifeindia.com
www.rifeindia.com

HongKong Office:
Ergonomic Corporation (Hong Kong) Limited. 2nd floor Eton tower 8, Hysen Avenue Causeway, Hongkong.

☎ 852 - 61819896
✉ rishi@ergohongkong.com, ergohongkong@gmail.com
www.ergohongkong.com