



Computer Mobile Workstation Carts

Enjoy ergonomic health benefits of this stand up workstation. The height adjustable workstation or cart allows the monitor to be perfectly positioned to your liking while sitting or standing. It is standing desk at very economical cost. Each multifunction workstation includes a sliding keyboard shelf and CPU holder (Optional). Designed with 4 Casters, 2 of which are lockable, this cart can be stationed in one area or wheeled wherever necessary at home, office or school.

Ergonomic Corporation (Hongkong) Limited

Unit A, 3/F., Mai Tak Industrial Building, No. 221 Wai Yip Street,
Kwun Tong, Kowloon, Hong Kong

www.ergoshopping.com Sales@ergoshopping.com

WhatsApp : 852-51951285

Sit-Stand Computer Desk Workstation Advantages



This mobile stand up workstations helps you get rid of the sedentary work habit, relieve pressure along your back and reduce strain on neck and shoulders. You can raise and lower the desk smoothly from 57" to 69.3" easily



The height adjustable mount allows the monitor to be perfectly positioned to your liking while sitting or standing. It's great for office, medical station, warehouse, shopping mall, trade shows etc



Sleek appearance blends into any home decor. The measurement 25.39" x 14.37" x 0.66" of standing desk surface has plenty of space which can be used for any standard sized mouse, external keyboard, reading books etc.

Optional Accessories



Height Measurement

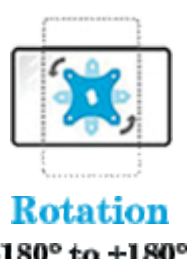
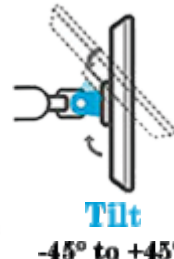
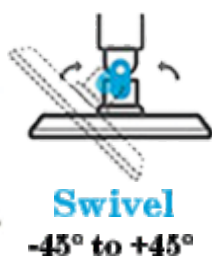
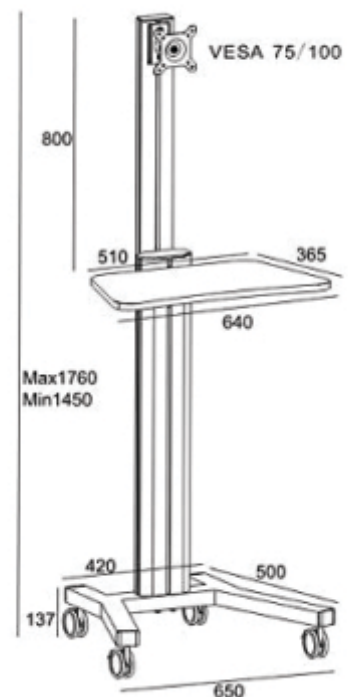

MCT-09B – Black Colour Body



MCT - 09 Specifications : (Black & White Body)

Product Size : 620(L) x 500(W) x 1450-1760(H)mm

Colour : Black and White

Max Capacity : 70Kgs

Material : Aluminium Column, Metal Base and
MDF Shelf for keyboard and Mouse

Feature : Cable Management

Height Adjustment : Sitting and Standing Position

Optional Parts : CPU Holder

Printer Shelf

Basket

Arms to add 2/3/4/5 Monitors



VESA Standard
75 x 75mm
100 x 100mm

Optional Accessories

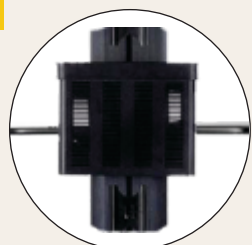

Basket

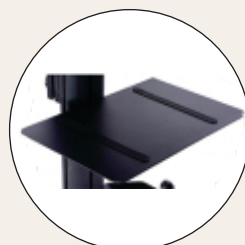

Printer Shelf

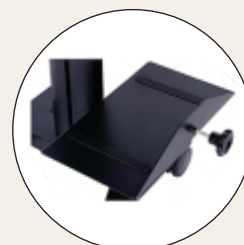

CPU Shelf

MCT-09W – White Colour Body



VESA Standard
75 x 75mm
100 x 100mm



MCT-10B- Black Colour Body



MCT-10W – White Colour Body



MCT-GB- Black Colour Body



with Gas Spring Arm



MCT-GW – White Colour Body



with Gas Spring Arm

