

everdure
by heston blumenthal



FORCE™ FURNACE™

Assembly, operation &
maintenance instructions

for Everdure by Heston
Blumenthal FORCE™ &
FURNACE™ gas barbecues
and stands

everdurebyheston.com

FORCE™

2 BURNER
GAS BARBEQUE



FURNACE™

3 BURNER
GAS BARBEQUE



Power by design.

THE OUTDOOR
PERFORMANCE

CONTENTS

Important Safety Instructions	4-5
Appliance Details	6
Outdoor Installation Guide	7
Operating Instructions	8-9
Ignition Procedure	10
Cleaning & Storage	11
Troubleshooting	12
Barbeque Assembly	13-17
Maintenance	17
Parts List: Barbeque Assembly	18-21
Warranty	22

OPERATION AND MAINTENANCE INSTRUCTIONS FOR E2G1GA, E2G1MA, E2G1SA, E2G1OA, E3G1GA, E3G1MA, E3G1SA and E3G1OA GAS BARBEQUE RANGE Everdure by Heston Blumenthal outdoor gas barbeques. It is important that you retain these instructions, proof of purchase as well as other important documents about this product for future reference. Due to continual product development, Everdure by Heston Blumenthal reserves the right to alter specifications or appearances without notice. Dispose of packaging responsibly – recycle where facilities are available.

IMPORTANT SAFETY INSTRUCTIONS

IMPORTANT: Read the safety precautions of this booklet carefully before removing the barbeque from its carton or connecting the barbeque to its gas supply. If you are unsure about anything regarding your barbeque, please contact Everdure by Heston Blumenthal in Australia on 1300 HESTON or in New Zealand on (09) 415 6000 before operating your appliance.

1. This gas barbeque and stand set are intended for OUTDOOR USE ONLY. This appliance must NOT be used indoors.
2. For your safety and enjoyment, read all operating instructions before lighting.
3. Ensure that all gas connections are tight before operating this appliance (refer to leak testing procedure in this manual). Always check for leaks when a gas cylinder is replaced or reconnected.
4. Unsupervised children or pets should not be near a barbeque while cooking or during warm up or cool down. Ensure children or pets are kept a distance well away from the barbeque whilst it is in use. Ensure that young children do not play with the appliance. This appliance is not intended for use by young children or infirm persons.
5. Particular care must be taken when removing the fat tray and the disposable foil trays. Mishandling of hot oil and fats can cause serious injury. Take care when changing plates & grills that parts are not hot & oil or fat does not drop onto the burner. Take care that the burner ports do not block up.
6. Turn gas valve/control knob and gas cylinder valve off after use. Do not allow build-up of unburned gas.
7. Never leave the burners on high for more than 10 minutes unless actually cooking. When cooking with the hood down, always follow the instructions in the Roasting section of this manual.
8. Do not move this barbeque set while in use or directly after use, as accessible parts may be very hot. The barbeque should only be lifted by the serveries at either side. Take care that undue pressure will not be placed on the gas hose, or turn off the gas supply & remove the hose from the cylinder or gas source (not at the barbeque). Take care that the fat tray & disposable aluminium foil tray are removed to minimise fat/oil spillage. When moving on the stand, leave the gas cylinder on the cylinder mounting hook for stability.
9. This barbeque has been designed to be used either on the supplied trolley or on a raised bench. When using a raised surface (table etc.), ensure the surface is level, large enough and strong enough to support the barbeque and will withstand temperatures of 60°C above ambient temperature. When using the stand, ensure that your barbeque is in a level position and the barbeque is secured onto the stand correctly (four screws at the barbeque base).
10. People with flammable clothing such as nylon etc. should keep well away from the barbeque when it is operating.
11. Do not use this appliance for any purpose other than what it is intended for.
12. In case of fat fire turn cylinder off. The fat tray should be cleaned and checked before using the barbeque. Disposable aluminium foil trays should be replaced before using the barbeque. Regular cleaning should reduce the build-up of fat and food residues which is combustible and can result in a fat fire. Fat fires can be prevented with diligence in cleaning your fat tray and regular replacement of aluminium foil trays. Do not allow the aluminium foil tray to overflow. Damage as a result of fat fire is not covered by your warranty and voids it. Do not use sand, kitty litter or fat absorbents in the fat tray or disposable aluminium foil tray.
13. Ensure that the product has adequate clearance from combustible materials. The appliance is designed so that heat will not affect the stand. All combustible materials must be kept more than 250mm from the sides and rear of the barbeque and more than 1500mm above the cooking surface of the barbeque.
14. If a burner makes a hissing sound when lit, it may be burning inside. Turn the burner off, allow to cool, and try ignition again. Keep your barbeque protected against strong wind – if this cannot be avoided, always check that the burners remain alight if operating the barbeque in windy conditions.
15. Do not carry out any servicing on the gas manifold of the barbeque yourself – this must only be done by authorised technicians.
16. We recommend that you regularly maintain your barbeque and keep it in good condition. This can be achieved by following the cleaning and maintenance suggestions in this booklet.
17. The barbeque and stand are designed to be used with either 4kg or 9kg gas cylinders. When not using the stand, the cylinder should be placed at a lower level to the barbeque, as far away as the hose will allow without undue tension on the hose, in a protected spot (so it does not receive any fat splatter from cooking or can be accidentally knocked over). When using the stand, the gas cylinder should be placed on the

dedicated cylinder mounting hook at the right hand side of the stand, not beside it.

The restraining chain will help to keep the cylinder vertical.

18. This appliance is not suitable for mounting in a movable vehicle (boat, trailer etc).
19. Do not use or store this appliance in areas of high salt content (a marine environment) or an area with caustic fumes or liquids (such as a domestic pool), as these chemicals can cause the appliance materials to deteriorate (and void the warranty). Regular cleaning and covering with an Everdure by Heston Blumenthal barbeque cover can help to reduce this.
20. Do not install in, or connect to the consumer piping or connect to the consumer piping or gas supply system of a boat or caravan.



DO NOT OPERATE THIS APPLIANCE BEFORE READING THE INSTRUCTION BOOKLET

DO NOT PLACE ARTICLES ON OR AGAINST THIS APPLIANCE

DO NOT STORE CHEMICALS OR FLAMMABLE MATERIALS OR SPRAY AEROSOLS NEAR THIS APPLIANCE

DO NOT OPERATE THIS APPLIANCE INDOORS

DO NOT ENCLOSE THIS APPLIANCE. THE MINIMUM CLEARANCE FOR THIS UNIT IS 1500mm ABOVE THE COOKING SURFACE AND 250mm FROM ANY SIDE

DO NOT LIGHT WITH HOOD DOWN

APPLIANCE DETAILS

Barbeque	FORCE™		FURNACE™	
Gas Type	ULPG	N.G	ULPG	N.G
Burner Pressure	2.75 kPa	1.0 kPa	2.75 kPa	1.0 kPa
Injector Diameter:	Ø0.95 mm	Ø1.60 mm	Ø0.85 mm	Ø1.45 mm
Heat Input:	23 MJ/ hr	23 MJ/ hr	29.1 MJ/ hr	29.1 MJ/ hr

Note: The size of the injector diameter is stamped on one of the hexagon faces (e.g. '165' for Ø1.65mm injector).

Barbeque	FORCE™			FURNACE™		
Barbeque only	LENGTH (mm)	WIDTH (mm)	HEIGHT (mm)	LENGTH (mm)	WIDTH (mm)	HEIGHT (mm)
		1170	515	410	1310	515
Barbeque and stand	1170	750	1170	1310	750	1170

Air is admitted at the underside of the combustion chamber (two 35mm x 20mm gaps between the fat tray and the chamber through an oval hole 75mm x 135mm in size). Exhaust gases are emitted around the edge of the plates (6mm gap) and through a 275mm x 40mm slot in the rear of the hood. When using an open grill, aeration also takes place through the slots of the grill.

GAS CONNECTIONS

LOCAL AUTHORITY REQUIREMENTS

Check Gas Type and specifications plate on the underside of the right-hand servery. All gas fitting work, service and repairs can only be performed by an authorised person in accordance with AS5601 and local gas regulations. Hose connections are G1/2-14 for ULPG & NG

NATURAL GAS

FORCE™ & FURNACE™ barbeques can be converted to use natural gas ONLY with a FORCE™ & FURNACE™ NG conversion kit. Fit the NG injector (into the valve), regulator and NG hose following the supplied instructions. Conversion of any barbeque from ULPG to NG (or vice versa) must be done by a licensed gas fitter/technician. Refer to AS5601 for piping sizes. Please contact Everdure by Heston Blumenthal for further information.

FOR ULPG CYLINDER CONNECTION

- To achieve the optimum performance from your barbeque, an approved gas cylinder (POL fitting) of 4kg or 9kg capacity must be used. Take care to keep the hose away from the hot barbeque.
- Do not connect gas to a barbeque that is not secured in the supplied stand or on a stable raised surface. The cylinder must be placed on the cylinder support hook at the right hand side of the stand when one is used. The cylinder should be lower than the barbeque & in a protected place when not using the stand.
- Connect the cylinder to the barbeque, via the hose and regulator. Firmly tighten joints, but do not over-tighten. Take care not to damage the regulator fitting. Check that the gas control knob/valve is in the Off position before opening the gas cylinder.

NOTE: Only one gas cylinder should be stored on the stand at any one time.

LEAK TESTING

- Make sure the gas control knob is Off and turn the cylinder valve On.
- Check for leaking joints by brushing with solution of half-liquid detergent and half water. If a leak is present, bubbles will appear (or you may hear a hissing sound). Retightening connections can generally repair a leaking joint. You must also check the gas hose and connection at the gas cylinder. If a leak cannot be resolved, do not proceed.



DO NOT USE NAKED FLAME FOR LOCATING GAS LEAKS.

IF A LEAK PERSISTS CALL AN AUTHORISED GAS FITTER.

OUTDOOR INSTALLATION GUIDE

This Appliance shall only be used in an above ground open-air situation with natural ventilation, without stagnant areas, where gas leakage and products of combustion are rapidly dispersed by wind and natural convection.

This appliance **must not** be used indoors. Do not use your barbeque in garages, porches, sheds or other enclosed areas. The barbeque is not intended to be installed in or used on recreational vehicles (e.g. boats, camping vans) and should not be placed close to or under any surfaces that will burn or are sensitive to heat. Do not block/obstruct the flow of air and combustion around the barbeque housing while in use.

Any enclosure in which the appliance is used shall comply with one of the following:

- An enclosure with walls on all sides, but at least one permanent opening at ground level and no overhead cover.
- Within a partial enclosure that includes an overhead cover and no more than two walls
- Within a partial enclosure that includes an overhead cover and more than two walls, the following shall apply-
 - (i) at least 25% of the total wall area is completely open: and
 - (ii) at least 30% of the remaining wall area is open and unrestricted.

In the case of balconies, at least 20% of the total of the side, back and front wall areas shall be and remain open and unrestricted.

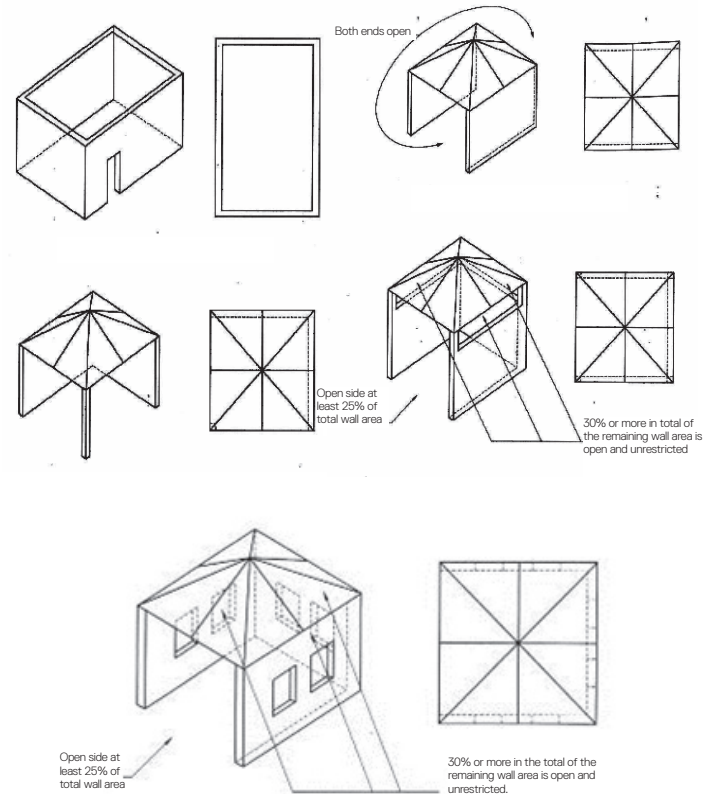

OPERATING INSTRUCTIONS

GENERAL INSTRUCTIONS

A fairly protected location is desirable for pleasant and efficient cooking. Try to keep the barbeque sheltered from strong winds as this will drastically reduce cooking efficiency. If this is unavoidable, position the length of the barbeque to be parallel in the direction of the wind. Keep the barbeque level. Check frequently that the burner remains alight when used in conditions of strong wind (through the viewing hole on the left hand side of the chassis or through open grills). Make sure the minimum distances of the barbeque to any wall or combustible surface are met, and that when not using the stand, the supporting surface can withstand the heat. When using the stand, take care that the barbeque is locked in position using the locks on the castors & the hose is not touching any hot surface. For more specific information (including set-up illustrations and diagrams) and up to date cooking instructions, please visit the Everdure by Heston Blumenthal website at www.everdurebyheston.com.

GAS TYPE AND CONSUMPTION

The barbeques are designed to operate on Universal LPG only (Propane and/or butane gas) and NG Gas (using a conversion kit). Gas consumption, Pressure and Injector Orifice size are shown on the Data Plate found under the right hand servery.

GAS CONTROL KNOB

The gas control knob locks in both the Off and High positions. By depressing the knob and turning anti-clockwise, gas flow will gradually increase until the High position is reached. Continue turning in this direction and gas flow will decrease until a simmer level is reached at Low. To turn gas flow off the gas control knob must be turned clockwise from Low, depressed at High and turned until the Off position is reached.

MATT VITREOUS CAST IRON OPEN GRILLS AND SOLID PLATE

The FORCE™ barbeques are supplied with an open grill for the left hand side and a flat, solid plate for the right hand side (this is the recommended general grill and plate configuration which will reduce the heat flowing over the control knobs) but can be reversed if required. The FURNACE™ barbeque has solid plate (right hand) and grill (left hand), and a central grill. Note that the grills and plates used on either barbeque cannot be used on the other model. The curved plates and grills can be used on either side of the barbeque. The open grills have a solid strip of cast iron built into the bottom of the grill used to protect the burner from dropping oil or food. The grill is fitted onto the supports built into the inside of the chassis. The plate should be placed beside it (flat surface facing upwards). When correctly allocated, there should be a 5-6mm gap between the grill(s) and plate, and the inner edge of the chassis. Any excess fat or liquid will flow into the chassis and drip through the barbeque into the fat tray and aluminium foil tray below the chassis. If burner ports become blocked, let the barbeque cool down & clean the burner with a wire brush. Other plates and grills can be purchased to combine with the ones supplied with this barbeque. For a list of accessories go to the Everdure by Heston Blumenthal website.

NOTE: The enamel coating can be damaged by steel utensils. Damage to plates and grills due to the use of metallic or sharp objects will not be covered under warranty.

FAT TRAY

Prior to use check that the fat tray is clean and lined with a disposable aluminium foil tray. Use only aluminium foil trays supplied for the barbeque, as trays of an incorrect size or height could cause problems with aeration to the barbeque or spilled fat and oils. Make sure the fat tray assembly is fully installed under the barbeque before operating the appliance.

UNDER NO CIRCUMSTANCES MUST SAND, KITTY LITTER OR FAT ABSORBENTS BE USED IN THE FAT TRAY OR FOIL TRAY.

ROASTING

Roasting (or running the barbeque with the hood down) should not be done with all control knobs set to high.

This is most important as severe overheating and spoilt food can result if these instructions are not followed.

Roasting is best done using a raised roasting rack, such as the Everdure by Heston Blumenthal roasting rack HBROASTR, which allows heated air to circulate around the meat, and fats to drip away from the meat.

Always set the barbeque up with the standard grill/plate combination as spelled out in the assembly instructions.

Cut a piece of foil slightly bigger than the roasting rack and place it in the centre of the barbeque on top of the plate and grills. Cut some slots through the foil so that excess moisture and fats can flow through the grill. Place the roasting rack centrally over the foil. Pre-heat the barbeque for 5 minutes with the hood down and the outer gas controls on high (for FURNACE™ barbeques, **leave the centre control knob off**).

Once the barbeque has reached ~180°C, open the hood, place the food on the roasting rack, close the hood and turn the control knobs down to low (these can be adjusted during roasting to keep the internal temperature stable, as weather conditions such as temperature and wind speed will affect the efficiency of the barbeque). Monitor the food cooking periodically until food is cooked.

ADJUSTING THE SERVERY

The left hand servery can be folded down to allow for easier storage (the right hand servery with the gas controls is fixed and cannot be adjusted). With the barbeque off and cool, place your left foot in front of the left rear leg to stabilise the barbeque and pull the servery forward to unlock it from the barbeque. With the servery fully extended, rotate it downward and release. See step 8 of the barbeque and stand assembly procedure for diagrams.

AFTER COOKING

1. When finished, make sure burner control knobs are turned **OFF**.
2. **TURN OFF THE GAS SUPPLY AT THE CYLINDER.**
3. After cooking and whilst the barbeque is still warm, remove scraps from the grill with a non-metallic scraper.
4. Excess fat and meat scraps can be scraped off the inside of the chassis by removing the grill/plate to gain access.
WARNING: Some surfaces may still be hot – please use protective gloves.
5. Clean the fat tray and replace the aluminium foil tray after or before each use of the appliance.
6. Once the barbeque is cool close the hood and wipe off any fat splatter from the stand with a clean cloth.

IGNITION PROCEDURE



READ ALL OPERATING INSTRUCTIONS BEFORE LIGHTING THE APPLIANCE

OPEN THE HOOD BEFORE LIGHTING

MAKE SURE THE GAS CONTROL KNOB IS IN THE 'OFF' POSITION AND OPEN CYLINDER VALVE OR CONNECT THE NATURAL GAS SUPPLY (AFTER NG CONVERSION ONLY)

MAKE SURE THE GRILL AND PLATE ARE IN THE CORRECT POSITIONS FOR COOKING

WARNING: STORE CYLINDER IN A WELL VENTILATED AREA OUT OF REACH OF CHILDREN

LIGHTING THE BARBEQUE USING THE BUILT IN IGNITION ON THE CONTROL KNOBS

The FORCE™ and FURNACE™ barbeques have a rotary ignition system built into the gas valves, accessed by using the control knobs built into the right hand servery. To ignite a burner, push the appropriate control knob down and slowly rotate anti clockwise. This starts releasing the gas into the burner. As the knob reaches the ignition symbol on the control panel, a spark will ignite the gas in the burner. The knob can then be rotated the rest of the way to "HIGH" and released, or adjusted to the appropriate temperature setting.

If the burner does not ignite, return the control knob to the "OFF" position and retry. If there is still no ignition after 5 attempts, leave the barbeque off and retry again in 5 minutes time.

There are 2 control knobs on the FORCE™ barbeques and 3 control knobs on the FURNACE™ barbeques (one for each burner under a plate or grill). The control knob closest to the rear controls the burner to the right. The control knob closest to the front controls the burner to the left. The central control knob (FURNACE™ barbeque only) controls the centre burner.

CLEANING & STORAGE

EXTERNAL CLEANING

Before cleaning the barbeque exterior and stand, ensure the appliance has cooled and is safe to touch. Painted and plastic surfaces can be cleaned using a mild household detergent or cleaner and a clean cloth (do not use scourers or harsh detergents). **It is advisable to test cleaners on a small section of the appliance first. NEVER** use paint thinners or similar solvents for cleaning and **NEVER** pour cold water over hot surfaces. Dry the surface afterwards.

INTERNAL CLEANING

Before cleaning the internal parts of your barbeque, ensure the appliance has cooled and is safe to touch. The inside of the hood can be cleaned by using some water, mild detergent and a sponge or mild scouring pad. The non-stick coated surface of the hot plate should be cleaned carefully so as not to scratch the surface as above, preferably when the surface is still warm. For hard to clean areas, use a little baking soda on a wet sponge. Do not use abrasive cleaners.

WARNING! The surfaces of the plates may be hot. Please ensure protective gloves are worn.

STORAGE

When the appliance is not in use, the cylinder valve must be turned OFF, the barbeque, stand and the cylinder together must be stored outdoors in a well ventilated area. However it is permissible to store the appliance (but not the cylinder) indoors. Ensure the cooking surface is clean before storing away.

When the gas cylinder is disconnected, replace the plug or cap on the valve outlet. For extended storage it is suggested that the primary air-port of the burners be covered against the penetration of insects or vermin. Spiders and small insects can spin webs or nest in the burner rails/tubes, which could lead to obstruction in the gas and air flow, resulting in a fire in an around the burner rails/tubes. This type of fire is called a flash-back and can cause serious damage to your barbeque and create an unsafe operating condition. To prevent this, regularly inspect and clean the burners. Use an Everdure Heston Blumenthal FORCE™ or FURNACE™ barbeque cover for extra protection, and to reduce this.

TROUBLESHOOTING

Burner will not ignite when using the igniter:

Cylinder valve is not on	Turn cylinder valve on
Cylinder is empty	Replace with a full cylinder
Igniter is not sparking	Remove plate and visually check ignition box for a spark. Check that the cables to ignition point, or from the valve to the chassis have not broken or disconnected. Also check the alignment of the sparker. If there is no spark, contact Everdure by Heston Blumenthal Service.
Injector is blocked	Clean injector with a toothbrush. Do not drill out or use wire. Do not remove injector. Contact Everdure by Heston Blumenthal Service.

Burner flame is erratic:

Burner is blocked	Remove cooking surface and check burner for obstruction. Clean ports.
Flame is burning inside burner (hissing sound)	Turn off burner, allow to cool and re-ignite.
Regulator is faulty	Contact Everdure by Heston Blumenthal Service.
Injector is partially blocked	Clean injector with a toothbrush. Do not drill out or use wire. Do not remove injector. Contact Everdure by Heston Blumenthal Service.











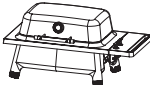









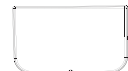

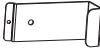
Gas is leaking from connections:

Connections are loose	Tighten loose connections (do not over-tighten) and leak test under pressure with soapy water solution (page 6).
Hose has deteriorated	Contact Everdure by Heston Blumenthal Service - replace.
Gas valve is faulty	Contact Everdure by Heston Blumenthal Service.
Threads are damaged	Contact Everdure by Heston Blumenthal Service.

BARBEQUE AND STAND ASSEMBLY

The barbeque and hood come fully assembled, with the gas hose connected to the inlet manifold. To assemble, the stand must first be built (note: for transportation reasons, the barbeque is packaged bolted to the stand top, and should be removed before attempting to assemble the stand). The barbeque is placed back inside the stand after it has been assembled and reattached (it can be removed to cook from a raised bench). Only a medium size Philips screwdriver is needed. Open the carton from the top and remove the parts. Remove all packaging (especially check inside the barbeque chassis) and place parts on a clean surface. Check for any damage or missing parts (if found, contact your service department).

INCLUDED PARTS FORCE™ AND FURNACE™

01/ Hood, barbeque chassis and 01B stand top assembly x 1Pc	02 / Left front leg x 1Pc	03 / Left back leg x 1Pc	04 / Right front leg x 1Pc	05 / Right back leg x 1Pc	06 / Bottom shelf support x2Pcs	07 / Bottom shelf x 1Pc	08 / Cast iron grill x 1pc (FORCE model only)
							
09 / Cast Iron plate x 1Pc (FORCE model only)	10 / Cast iron middle grill x 1Pc (FURNACE model only)	11 / Cast iron grill x 1Pc (FURNACE model only)	12 / Cast iron plate x 1Pc (FURNACE model only)	13 / Fat tray x 1Pc	14 / Cylinder hook x 1Pc	15 / Gas cylinder support chain x1Pc	15/ Left Hand Servery x 1Pc
							
A / Bolt M6x12 x 15Pcs	B / Bolt M5 x 12 x 4Pcs	C / Nut M6 x 3Pc	D / Spring washer Ø6 x 5Pcs	E / Spring washer Ø5 x 4Pcs	F / Flat washer Ø6 x 8Pcs	G / Bolt M6 x 85 x 2Pcs	H / Hinge Spring x 2Pcs
							

PACKAGING Remove all internal cartons and packaging from within the barbeque/hood assembly. Remove all external packaging and remove the appliance from the packaging base before operation. Recycle as per your local government laws.

STEP 01

/Open the hood and fix the hood handle (14) using two M5x30mm screws (F), two Ø5mm spring washers (C), two Ø6mm flat washers (E) and two Ø5mm fibre glass washers (G).
Tighten in place

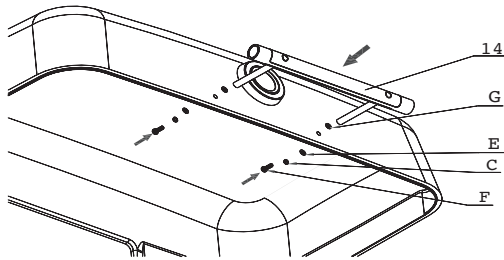

STEP 02

/The hood and barbecue chassis assembly is transported screwed to the stand top by four M6x20mm screws and four Ø6mm spring washers (two at the front and two at the rear).
Before attempting to build the stand, the stand top should be removed.

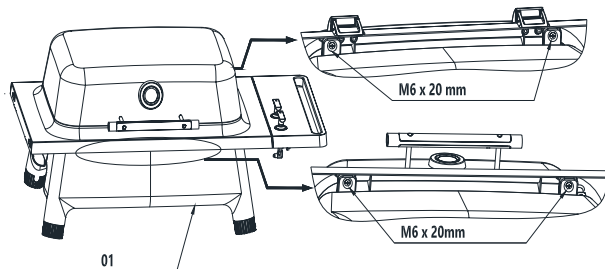

Angle the assembly slightly to the back and remove both M6x20mm screws, then do the same at the front, supporting the parts so they don't drop. Keep all of the fasteners for later use. Removable stickers at the front and rear will mark the positions of these screws. Remove the hood and barbecue chassis assembly from the stand top and place on the ground.

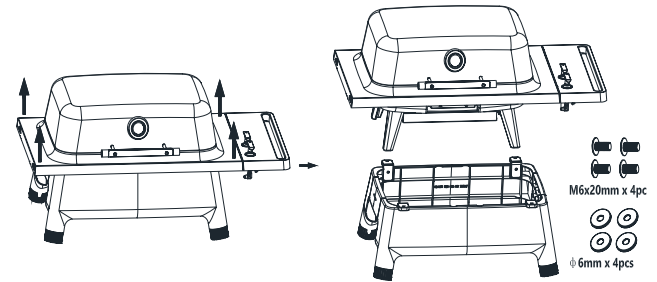

STEP 03

/Take the stand top (01B) and place it upside down (leg stumps up) on a clean surface (note: there is no front or rear to this part). Take the right front leg (04 with a screw hole in the foot) and slot it over the rear right corner stump. Fix in place using a M6 x 12mm screw (A) and flat washer (E), but do not tighten. Take the right rear leg (05 with a screw hole in the foot) and slot it over the front right corner stump. Fix in place using a M6 x 12mm screw (A) and flat washer (E), but do not tighten. Take the left front leg (02) and slot it over the rear left leg stump. Fix into place using a M6x12mm screw (A) and flat washer (E), but do not tighten. Take the left rear leg (03) and slot it over the front right leg stump. Fix into place using a M6x12mm screw (A) and flat washer (E), but do not tighten.

STEP 04

/ Take the two bottom shelf supports (06) and fit them onto the cylindrical tabs at the inside of each foot. Rotate each one so that the outmost screw holes are facing inwards and the inner screw holes are facing the stand top (if not, pull out and fit in the opposite way). Fix in place with four M6x12mm screws (A) and spring washers (D). When all are assembled, tighten up all four screws and the screws from step 02.

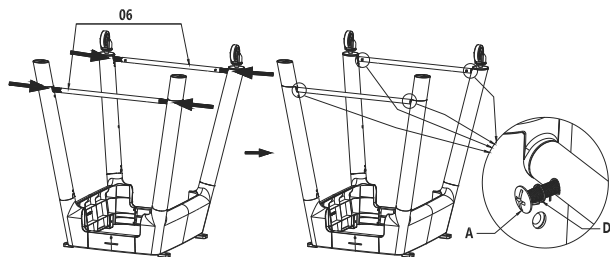

STEP 05

/ There are two threaded holes at the inside of the right hand legs. Take the support chain (15) and fix it to the two legs with two M6x12mm screws (A). Tighten fully.

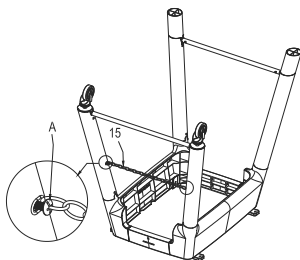

STEP 06

/ Turn the stand onto its legs and check that all of the legs are stable. Take the plastic bottom shelf (07) and place it on the two bottom shelf supports. Line the four holes in the bottom shelf up with the threaded holes in the bottom tray supports and fix into position using four M5x12mm screws (B) and four spring washers (E). Tighten fully.

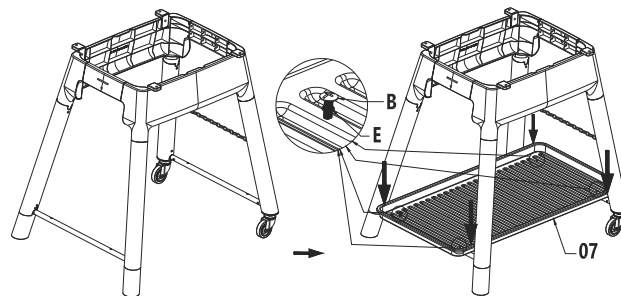

STEP 07

/ Push the flat edge of the cylinder hook (14) into the slot of the stand top (above the right hand side legs and castors) up until the dogleg, and then rotate down until the hook is against the stand top side. Fix into place using a M6x12mm screw (A), M6 locking nut (C) and spring washer (D). The stand is now complete.

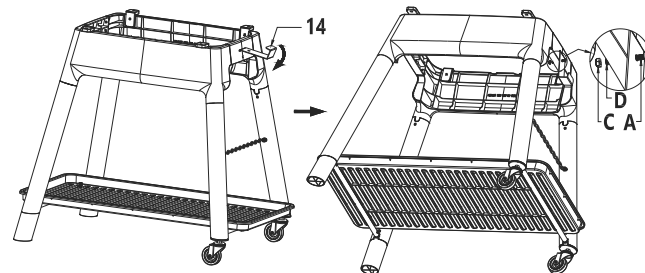

STEP 08

/Push the flat edge of the cylinder hook (12) into the slot of the stand top (above the right hand side legs and castors) up until the dogleg, and then rotate down until the hook is against the stand top side. Fix into place using a M6x12mm screw (A), M6 locking nut (H) and spring washer (D). The stand is now complete.

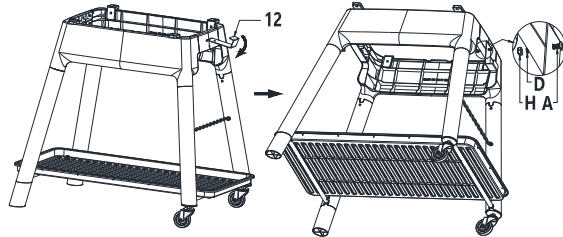

STEP 09

/Position the stand with the castor wheels to the right. Two people should lift the barbeque and hood assembly (01A) by the serveries, and place it within the stand (facing forwards, castors to the right). Fix the barbeque to the stand top with the four M6x20mm screws and M6 spring washers removed at step 1 – two to the front and two to the rear. Tighten fully.

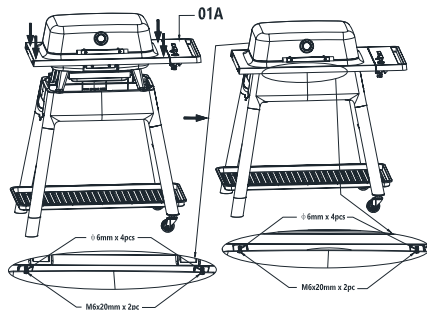

STEP 10

/To attach the left hand side servery (15) to the BBQ chassis (01B) support the left hand side servery and align the locating tabs to the keyholes and slide the left hand servery backwards (approximately 1cm). Fit Spring (J) onto M6 x 85mm Screw (I) and secure with M6 Nut (H).

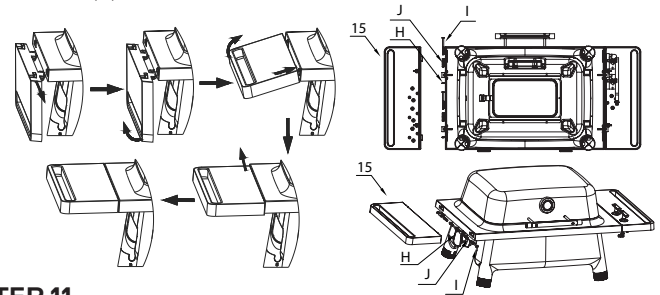

STEP 11

/Fit the fat tray (11) and disposable foil tray into the brackets at the bottom of the barbeque. Take care that the fat tray is allocated correctly.

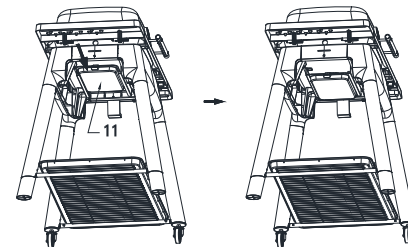

*Due to ongoing design modifications, support brackets may be permanently fixed to the element

STEP 12

/Place the grills onto the barbeque as shown in the diagrams. Each grill should have a 5-6mm gap around each edge. Each grill will allocate in a groove on a plate support.

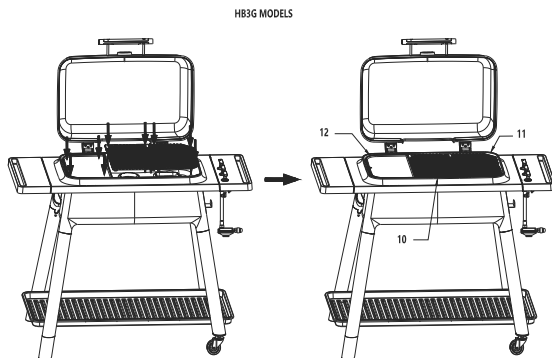

STEP 13

/ Hook the gas cylinder onto the support hook (14) and lean it against the support chain. If an Everdure by Heston Blumenthal gas cylinder cover is available, place around the cylinder, base up, and then tighten at the top (leaving the cylinder valve accessible). Connect the gas hose to the cylinder and tighten. Check all hose connections are tight, and that all control knobs are off before turning on the gas supply and leak testing.

MAINTENANCE

It is recommended that, at the commencement of each barbecue season, the following maintenance be conducted.

BURNER

1. Brush the outside of the burners with a stiff brush to remove rust and dirt. Make sure all ports are open.

GAS SUPPLY

1. Inspect the gas supply hose for any deterioration and replace it if necessary.
2. Test the gas circuit for leaks and remedy any found.

BARBEQUE, HOOD AND PAINT FINISH

It is recommended to clean the hood and firebox with a microfibre cloth before first use and regularly thereafter.

On rare occasions, the hood paint finish may change slightly due to heat. To restore the paint to its original finish, we recommend following the below instructions.

1. Never attempt to clean the BBQ whilst in use. Always allow the BBQ to cool before cleaning.
2. Once cool, apply a small amount of multi-surface polish to the top of the hood.
3. Using a microfibre cloth, gently wipe down until all polish residue has been removed
4. The paint finish should quickly return to its original gloss finish

STAND

1. Check all fasteners for tightness and re-tighten where necessary to ensure rigidity of the structure.
2. Wipe over barbecue stand with a clean cloth. Add a little oil or grease to all moving parts.

If connected to the barbecue, check the screws holding the barbecue and stand together are all fitted and tight. Wear and tear to this barbecue can be reduced by using a barbecue cover and storing out of the weather when not in use.

PARTS LIST: FORCE™ BARBEQUES

	PART NAME	QTY
1	Hood E2G1 (Mint)	1
	Hood E2G1 (Stone)	1
	Hood E2G1 (Orange)	1
	Hood E2G1 (Graphite)	1
	Hood E2G1 (Black)	1
2	Temperature Gauge Bezel	1
3	Temperature Gauge	1
4	Hood Handle Spacer	2
5	Hood Handle	1
6	Hinge	2
7	Right Hand Burner (E2G1)	1
8	Solid Plate (E2G1)	1
9	Barbeque Chassis (E2G1)	1
10	Control Knob	2
11	Control Knob Bezel	2
12	Right Hand Side Served (E2G1)	1
13	Gas Ignition Crossover Box (E2G1)	1
14	Electrode (E2G1)	2
15	Left Hand Burner (E2G1)	1
16	Open Grill (E2G1)	1
17	Served Spring	2
18	Left Hand Served	1

19	Injector Bracket (E2G1)	1
20	Injector Housing	2
21	Injector (E2G1)	2
22	Injector Housing Nut	2
23	Fat Tray Bracket (E2G1)	2
24	Barbeque Chassis Feet	4
25	Fat Tray Handle Cover	1
26	Fat Tray	1
27	Gas Tube Support	2
28	Gas Tube (E2G1)	2
29	Valve Support	2
30	ULPG Hose and Regulator Assembly	1
31	Gas Valve & Manifold Assembly (E2G1)	1
32	Stand Top Front/Rear Panel (E2G1)	2
33	Stand Top Spacer Bracket	4
34	Stand Top Side Panel	2
35	Cylinder Hook	1
36	Stand Top RR/FL Cap	2
37	Stand Top RL/FR Cap	2
38	Leg FL	1
39	Leg RL	1
40	Gas Cylinder Support Chain	1
41	Bottom Shelf (E2G1)	1
42	Leg Cap RR	1

43	Leg Cap FR	1
44	Bottom Shelf Support	2
45	Castor	2
46	Foot FL	1
47	Foot RL	1
48	Leg FR	1
49	Leg RR	1
50	Disposable Foil Tray	1
51	Spacer Bracket	4
52	Hardware Kit (not shown)	1
53	Logo Badge	1

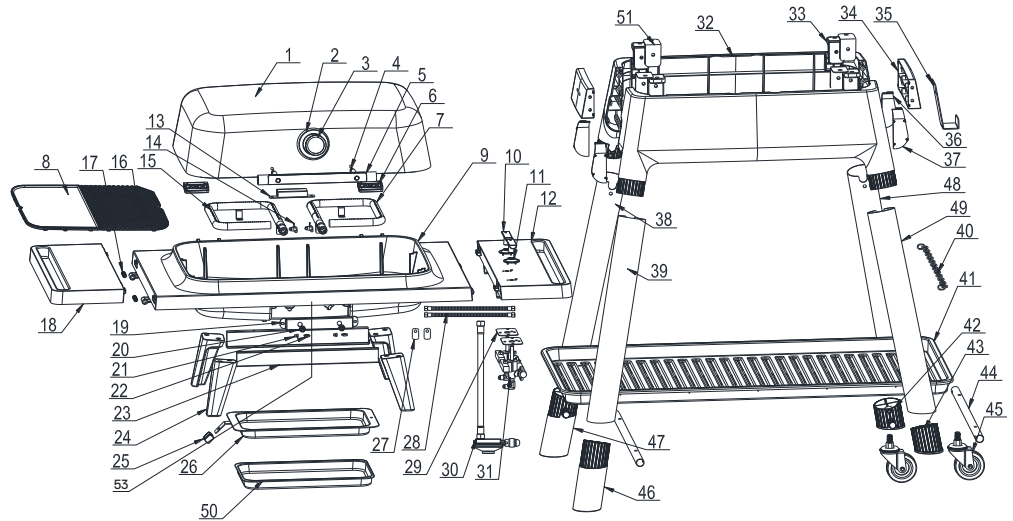

OPTIONAL ACCESSORY: COOKING ACCESSORIES

Please see everdurebyheston.com.au for a full range of accessories

PARTS LIST: FURNACE™ BARBEQUES

	PART NAME	QTY
1	Hood E3G1 (Orange)	1
	Hood E3G1 (Mint)	1
	Hood E3G1 (Stone)	1
	Hood E3G1 (Graphite)	1
	Hood E3G1 (Black)	1
2	Temperature Gauge Bezel	1
3	Temperature Gauge	1
4	Hood Handle Spacer	2
5	Hood Handle	1
6	Right Hand Burner (E3G1)	1
7	Hinge	2
8	Solid Plate (E3G1)	1
9	Barbeque Chassis (E3G1)	1
10	Control Knob	3
11	Control Knob Bezel	3
12	Right Hand Side Servery (E3G1)	1
13	Gas Ignition Crossover Box (E3G1)	2
14	Electrode (E3G1)	3
15	Left Hand Burner (E3G1)	1
16	Open Grill (E3G1)	1
17	Servery Spring	2
18	Left Hand Servery	1

19	Injector Bracket (E3G1)	1
20	Injector Housing	3
21	Injector (E3G1)	3
22	Injector Housing Nut	3
23	Fat Tray Bracket (E3G1)	2
24	Barbeque Chassis Feet	4
25	Fat Tray Handle Cover	1
26	Fat Tray	1
27	Gas Tube Support	2
28	Gas Tube (E3G1)	3
29	Valve Support	2
30	ULPG Hose and Regulator Assembly	1
31	Gas Valve & Manifold Assembly (E3G1)	1
32	Stand Top Front/Rear Panel (E3G1)	2
33	Stand Top Spacer Bracket	4
34	Stand Top Side Panel	2
35	Cylinder Hook	1
36	Stand Top RR/FL Cap	2
37	Stand Top RL/FR Cap	2
38	Leg FL	1
39	Leg RL	1
40	Gas Cylinder Support Chain	1
41	Bottom Shelf (E3G1)	1
42	Leg Cap RR	1

43	Leg Cap FR	1
44	Bottom Shelf Support	2
45	Castor	2
46	Foot FL	1
47	Foot RL	1
48	Central Burner (E3G1)	1
49	Central Open Grill (E3G1)	1
50	Leg FR	1
51	Leg RR	1
52	Disposable Foil Tray	1
53	Spacer Bracket	4
54	Baffle	1
55	Hardware Kit (not shown)	1
56	Logo Badge	1

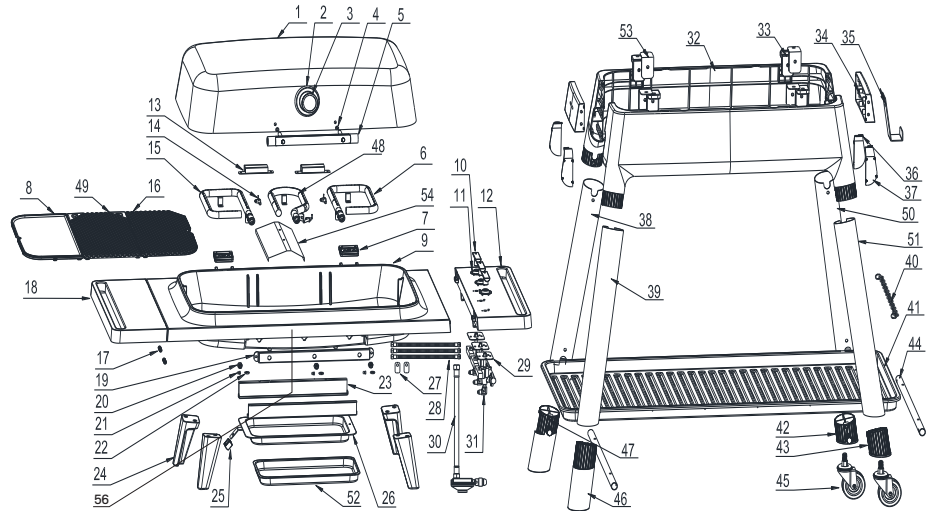

OPTIONAL ACCESSORY: COOKING ACCESSORIES

Please see everdurebyheston.com.au for a full range of accessories

FORCE™

2 BURNER
GAS BARBEQUE



E2G10A



E2G1GA



E2G1SA



E2G1MA



E2G1BA

FURNACE™

3 BURNER
GAS BARBEQUE



E3G1SA



E3G10A



E3G1MA



E3G1GA



E3G1BA

everdure
by heston blumenthal

A division of Shriro Australia Pty Ltd
Level 7, 67 Albert Avenue Chatswood NSW 2067
In Australia: 1300 766 066
In New Zealand: (09) 415 6000
www.everdurebyheston.com

IM Ref: FORCE&FURNACE 09/2021/15

FOR OUTDOOR USE ONLY

everdurebyheston.com