

breezesta™

**42"x 60" DINING TABLE**  
DH-0710

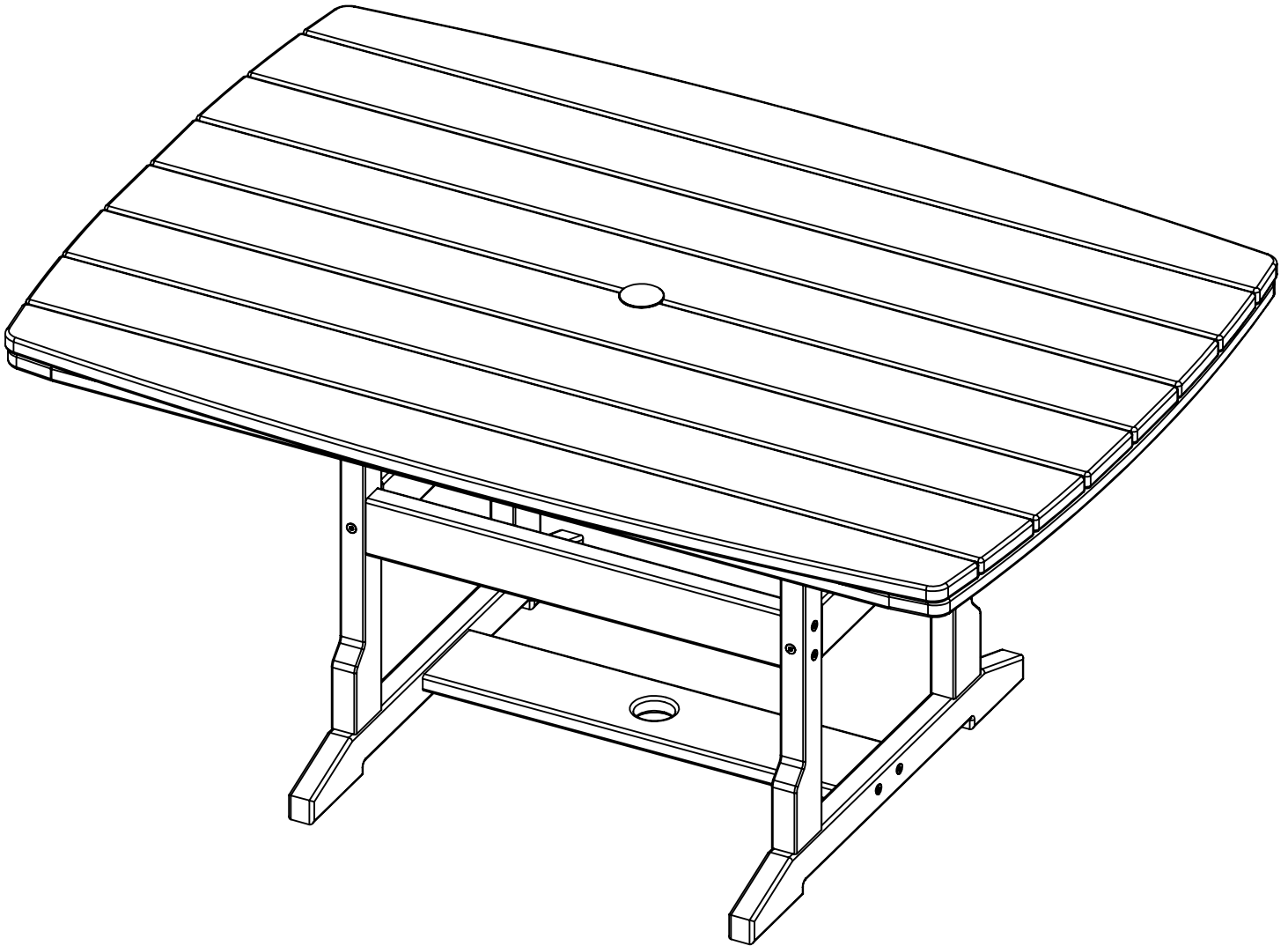

REV01-9/20

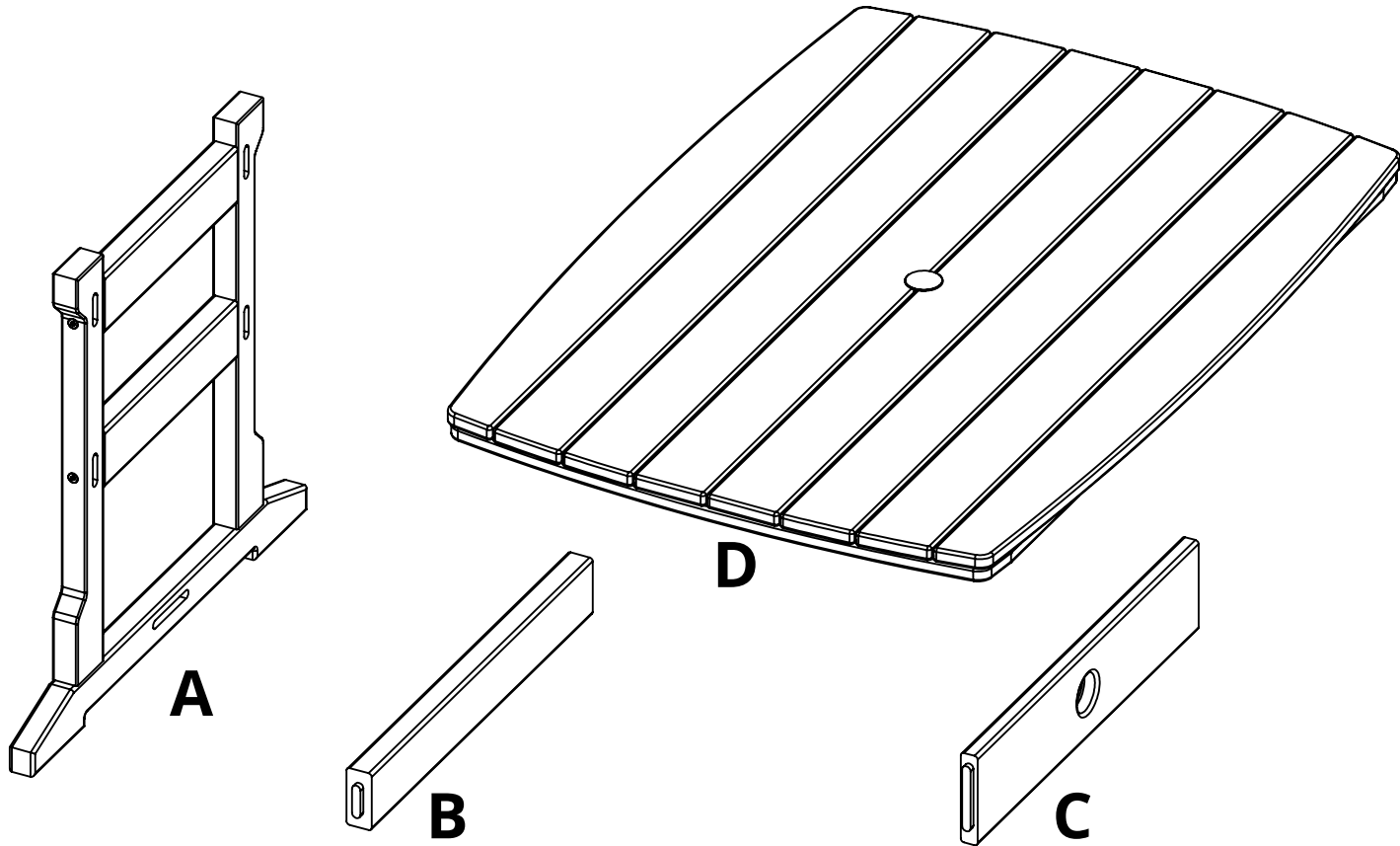

## PARTS

PART	DESCRIPTION	PART NO.	QTY
A	SIDE ASSEMBLY	SA-00318	2
B	SPREADER	PRT-00664	4
C	BASE SPREADER	PRT-00665	1
D	TABLE TOP ASSEMBLY 42"x 60"	SA-00328	1

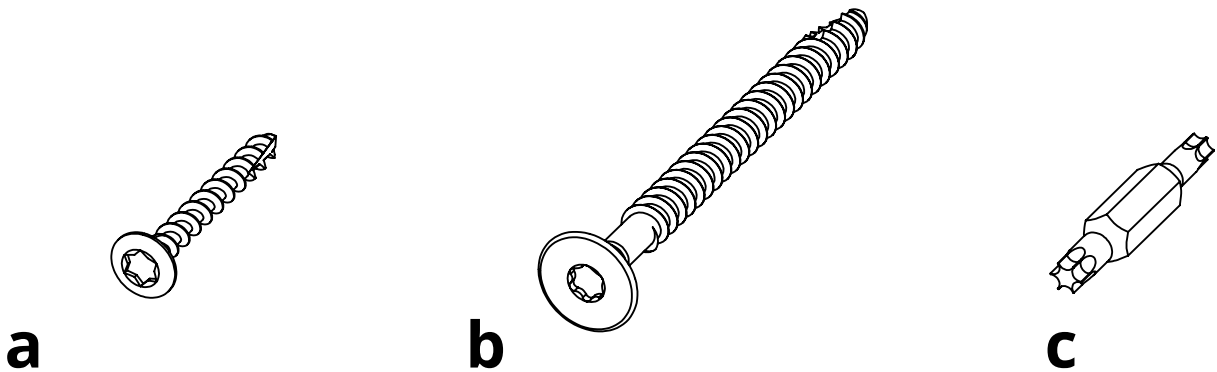

## HARDWARE

PART	DESCRIPTION	PART NO.	QTY
a	#8 X 2" TORX SCREW	H-0000-S82	4
b	1/4-10 x 3" LAG	H-0000-S103	20
c	T20 & T25 TORX BIT	H-0000-CTD	1

**Suggested Tools:** Drill, Plastic Mallet

# Please read entire instructions before beginning

1. Attach Part B and Part C to Part A using Hardware b

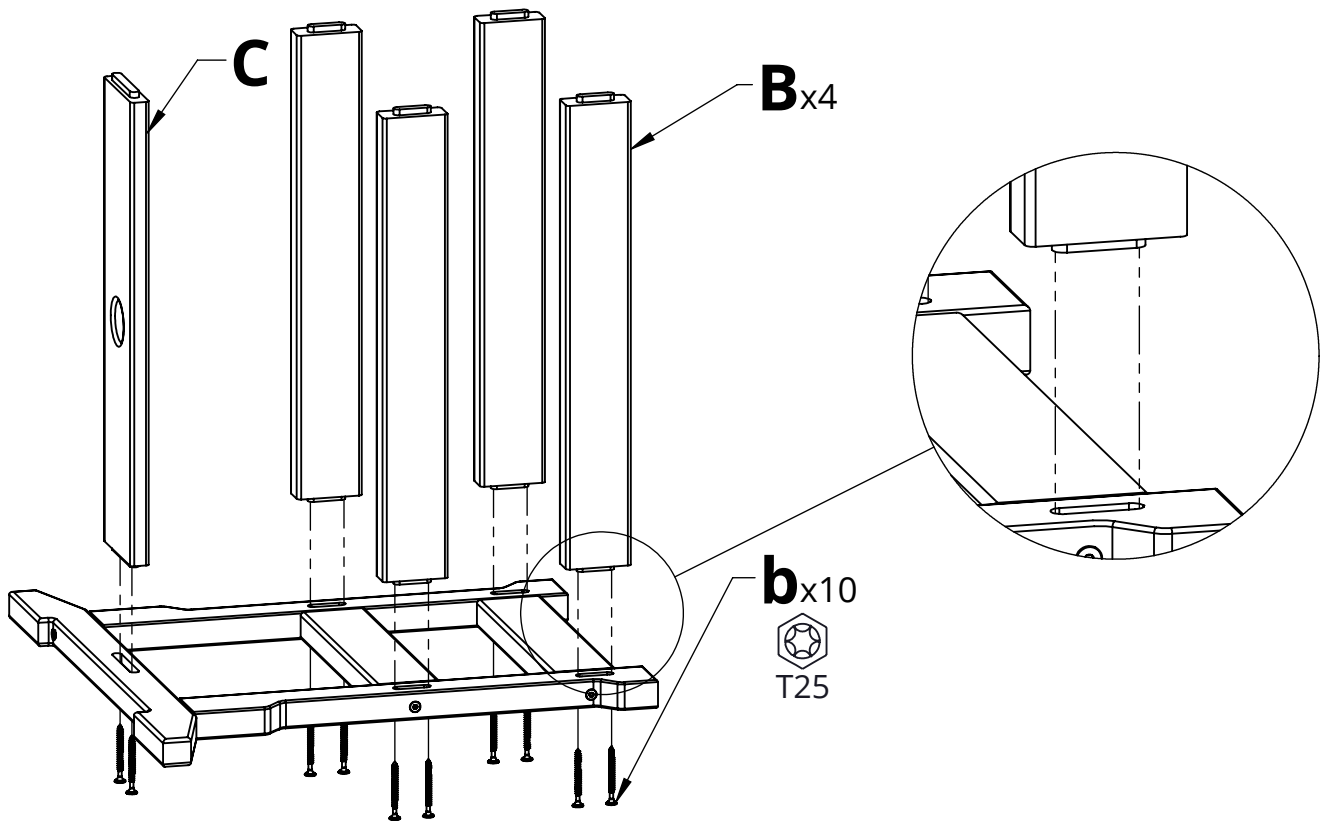

2. Place second Part A on assembled piece from Step 1; Repeat Step 1

3. Attach Part A onto Part D using Hardware a

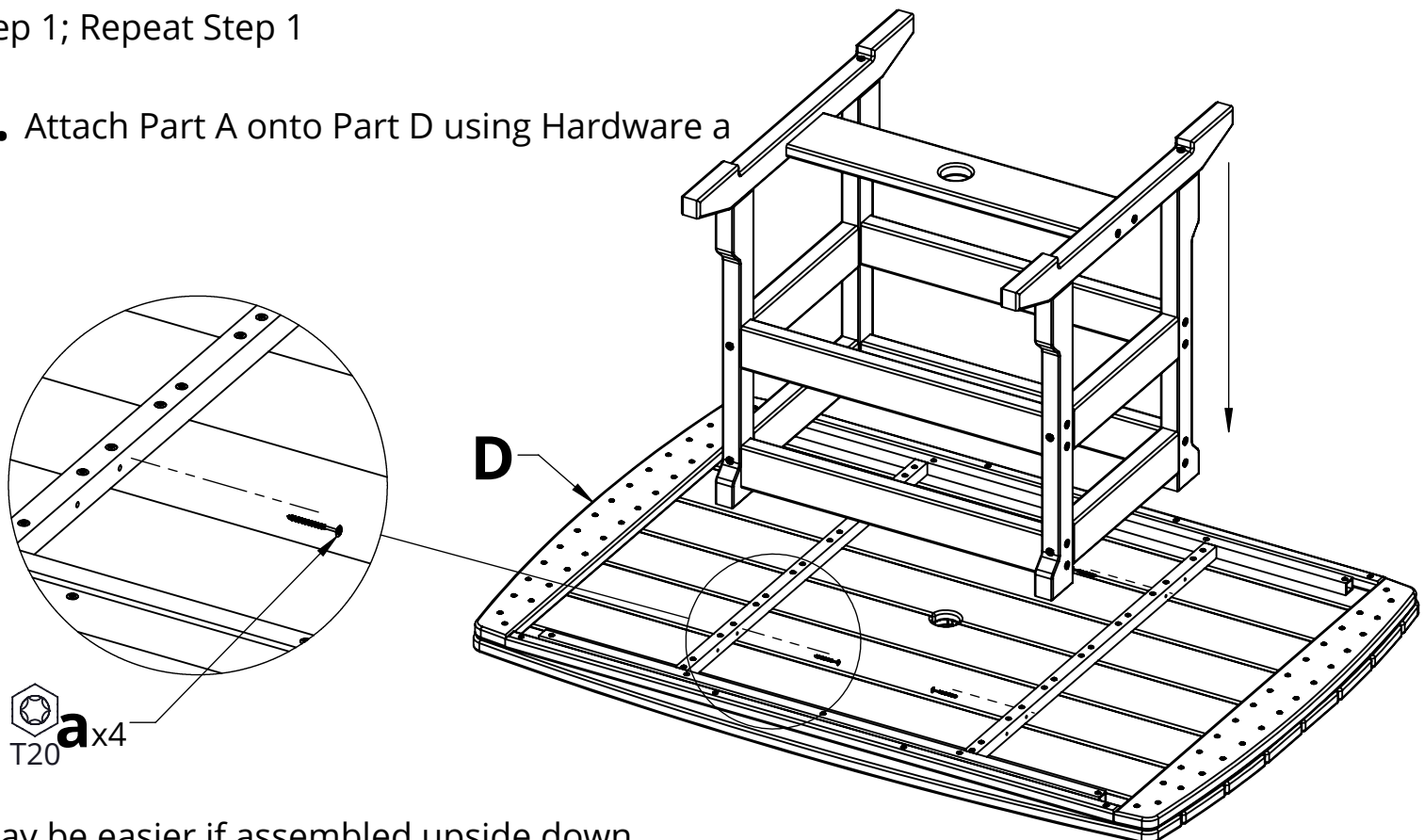

May be easier if assembled upside down