

breezesta™

48" ROUND COUNTER TABLE

CH-0809



REV02-3/21

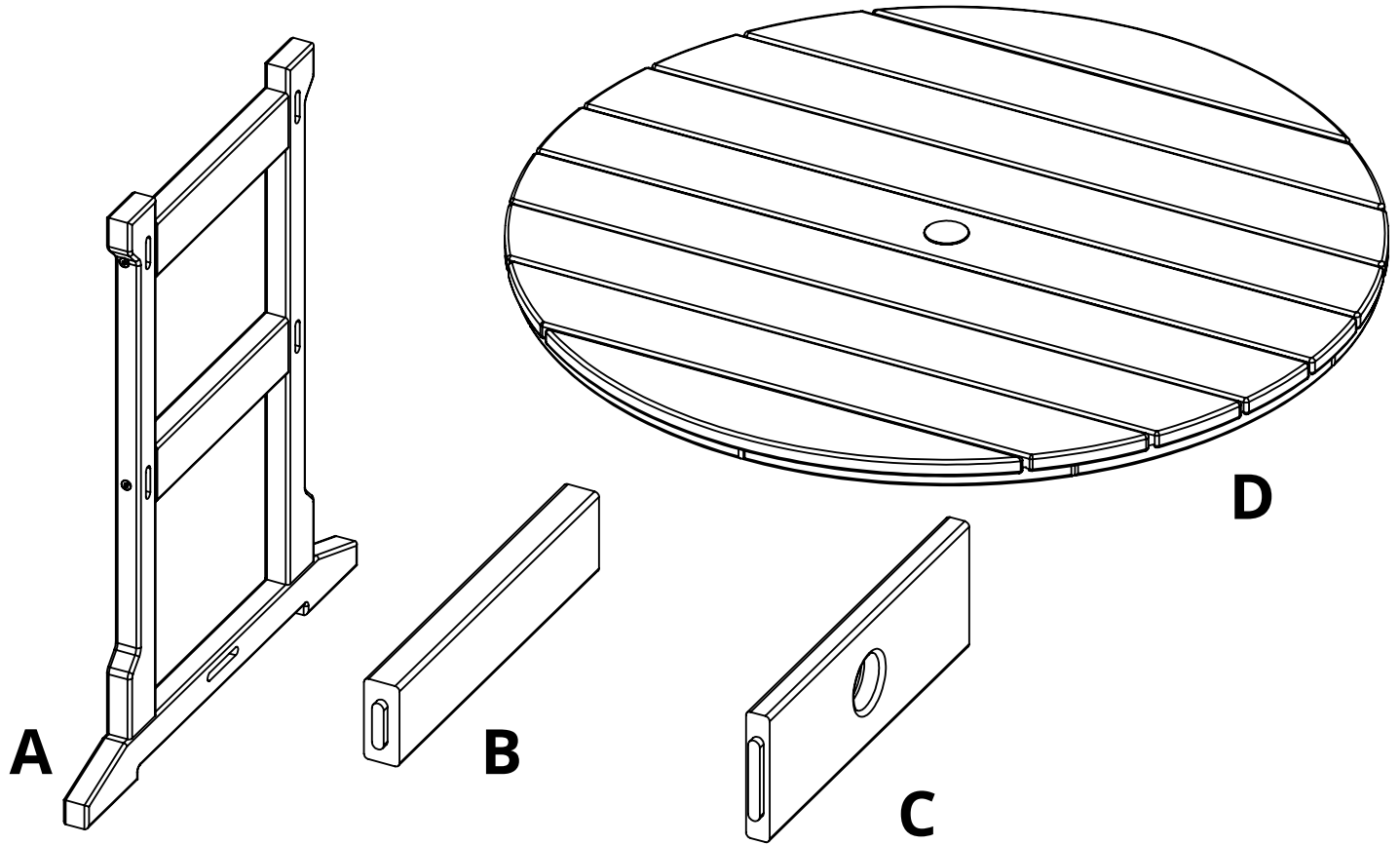

PARTS			
PART	DESCRIPTION	PART NO.	QTY
A	SIDE ASSEMBLY	SA-00243	2
B	SPREADER	PRT-00634	4
C	BASE SPREADER	PRT-00635	1
D	TABLE TOP ASSEMBLY 48" ROUND	SA-00319	1

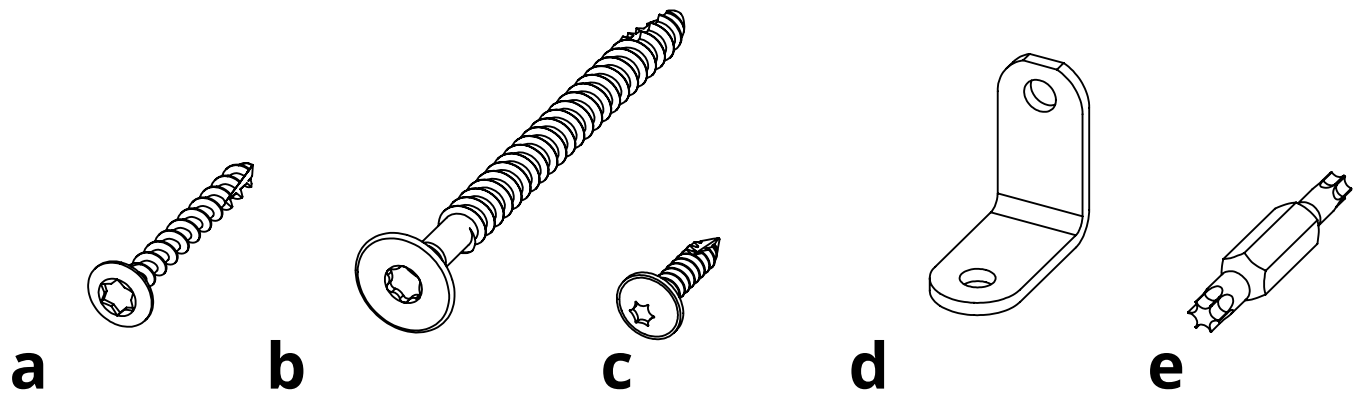

HARDWARE			
PART	DESCRIPTION	PART NO.	QTY
a	#8 X 1-1/2" TORX SCREW	H-0000-S815	4
b	1/4-10 x 3" LAG	H-0000-S103	20
c	#8 x 3/4" TORX SCREW	H-0000-S834	4
d	L BRACKET FOR TABLE TOPS	H-0000-MLB	4
e	T20 & T25 TORX BIT	H-0000-CTD	1

Suggested Tools: Drill, Plastic Mallet

Please read entire instructions before beginning

1. Attach Part B and Part C to Part A using Hardware b, attach Hardware d to Part A using Hardware a

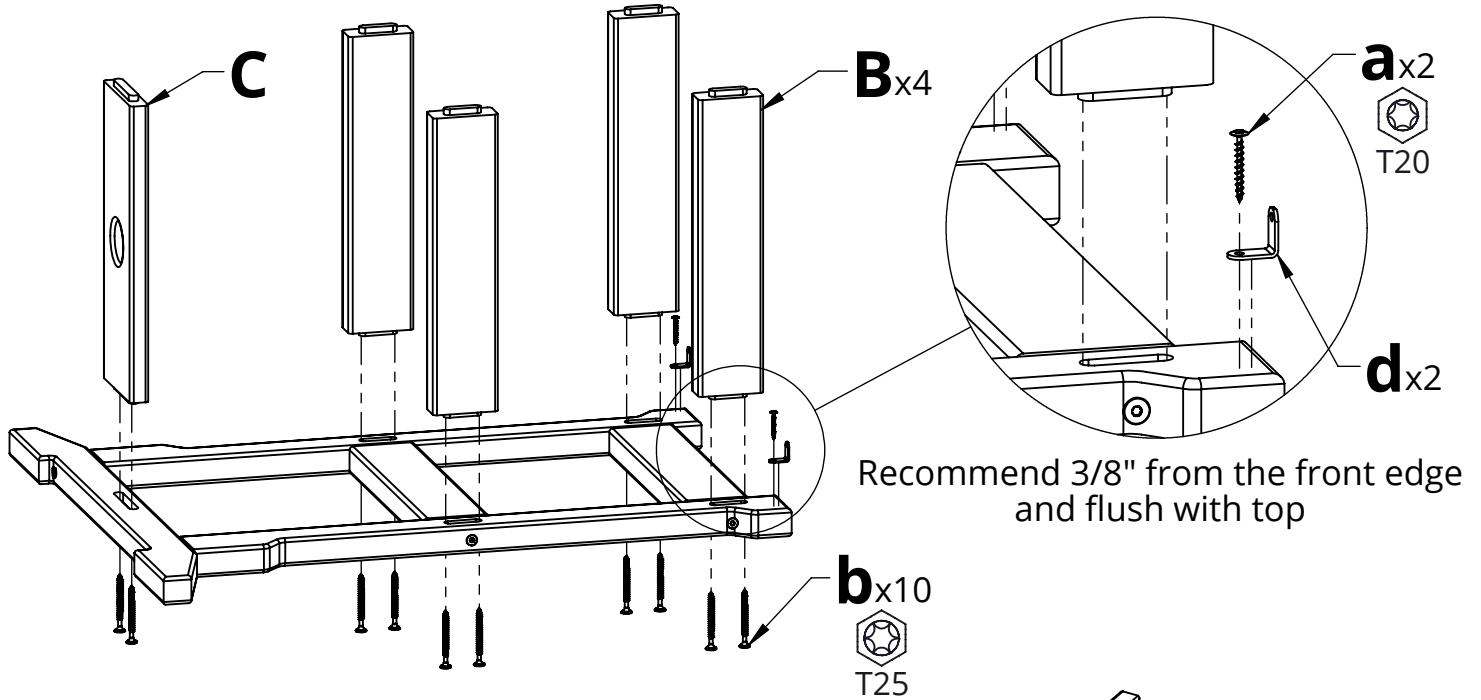

2. Place second Part A on assembled piece from Step 1; Repeat Step 1

3. Place Part A onto Part D, attach using Hardware b through Hardware d

