

Electric scooter

Welcome to use

Thank you for choosing TO electric scooter (hereinafter referred to electric scooter, electric scooter is a stylish sports entertainment equipment

Contents

1. Product and parts -----	2
2. Functional sketch -----	3
3. Body assembly -----	4
4. Charger Connection -----	5
5. Learning to drive -----	5
6. Safety instructions -----	7
7. Folding and transporting -----	12
8. Daily maintenance -----	13
9. Model parameter table -----	15
10. Name and content of harmful substance in the product -----	16
11. Warranty policy -----	17

1.Product and parts

Whole scooter

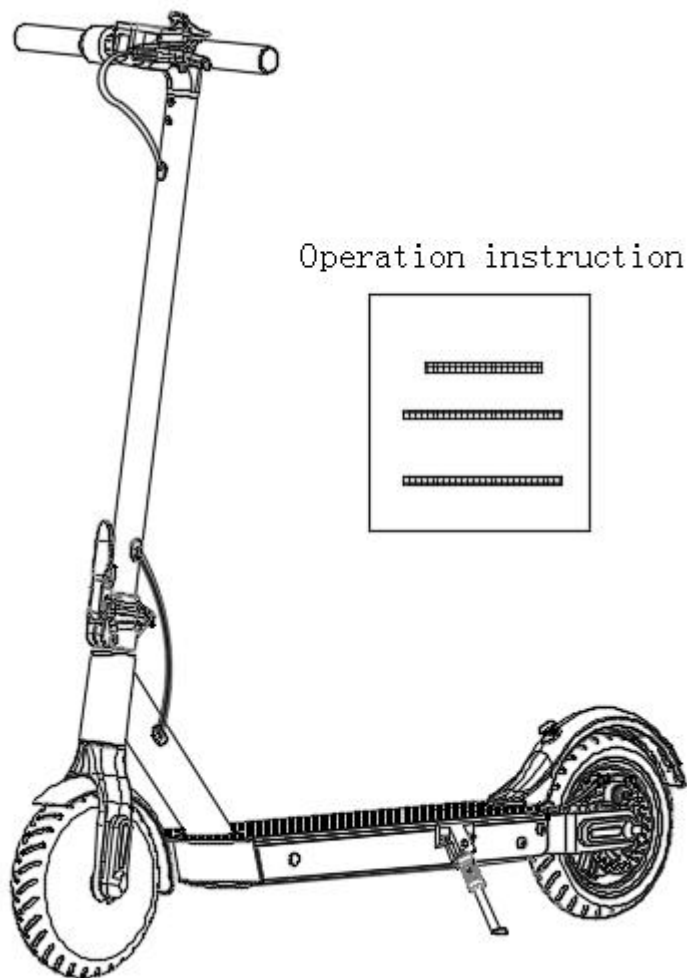

Access

Screw x 4



Socket head wrench



Charging adapter



Please carefully check whether the contents of the box are intact.

2.Functional Sketch

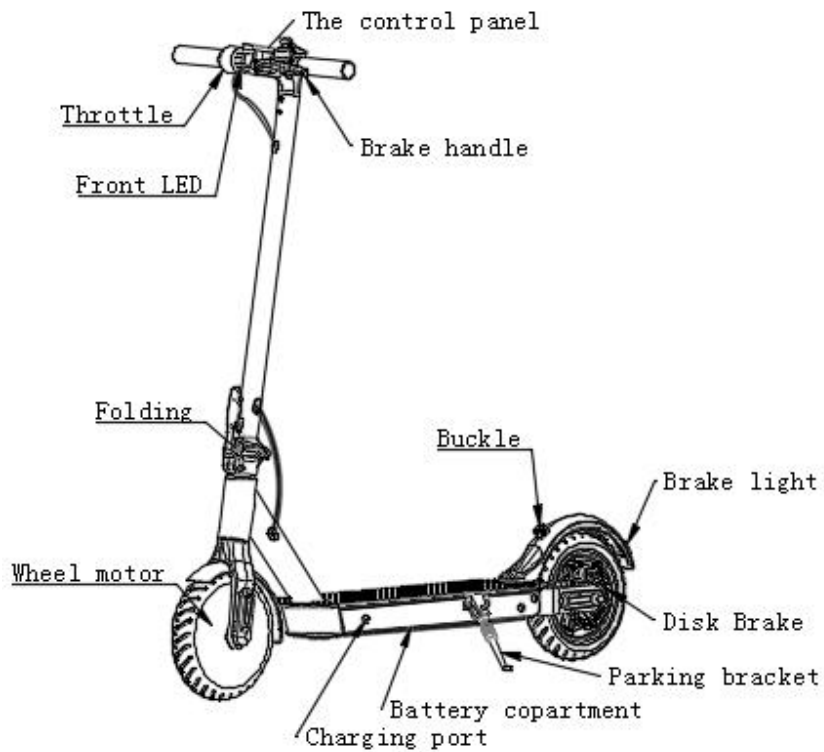

The control panel

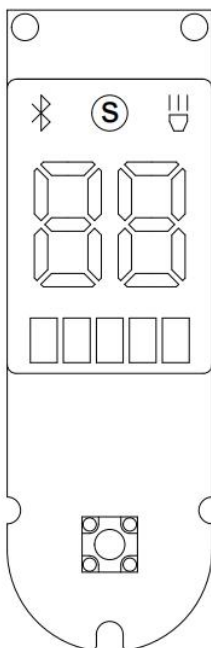

Speed display	Showing normal running speed while riding. When comfortable mode, the max speed is 20km/h; when sport mode, the max speed is 25km/h.
Battery indicator	There are four electric lights to indicate the amount of electricity. With battery consumption, the power light status will change from the top to the bottom in order of light on, flashing, and extinction. When 4 lights are on, the electricity is between 100%-80%; when 3 are lights on, the electricity is between 80%-60%. When the battery is used up, the four lights are all extinct, and the scooter will slide to the natural stop by inertia, please recharge it before using.
Power switch	When the scooter is power on, short press the switch to open the vehicle; long press the switch for 2S can turn it off. After turning on the vehicle, short press the switch can turn ON/OFF the Light; Press the switch twice in a row, switch between comfortable and sport mode.(The bottom light will be green when it changes to comfortable mode.)
Cruise control	<ul style="list-style-type: none"> - Activate CRUISE CONTROL mode: press and hold the accelerator lever at the same speed for 5 seconds. - Turn off CRUISE CONTROL mode: Braking with the brake lever, the cruise control mode will turned off (when decelerating, the cruise control mode is turn off).

3.Body assembly

1. Secure the scooter standpipe and open the parking bracket.

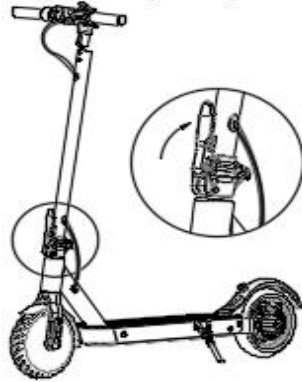

2. Install the crossbar on the standpipe.

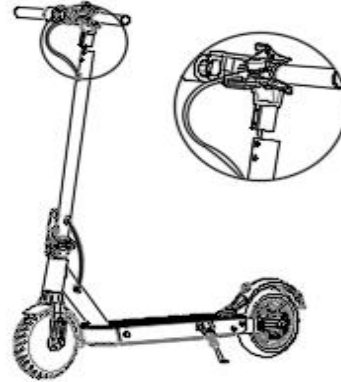

3. Use the hex wrench in the packing box to lock screws on both sides.

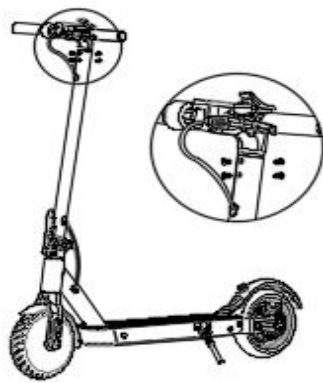

4. After the completion of the installation to carry out switch detection.



4.Charger connection

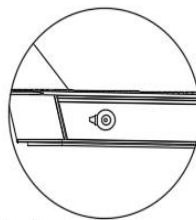
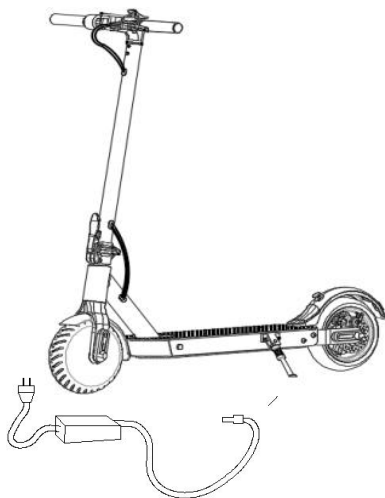

1. Open the rubber stopper

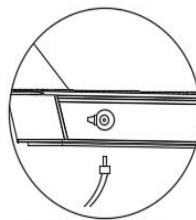

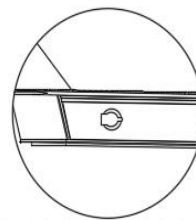

2. Insert the charging plug

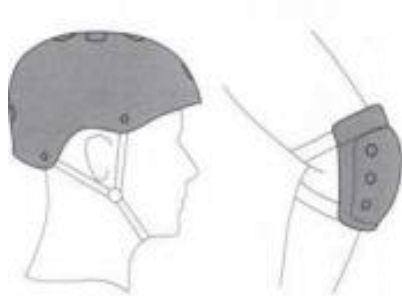

3. After checking, close the rubber stopper

5. Learn to drive



 There is a risk of falling injury during the study period, so please wear a helmet and a protective gear as shown

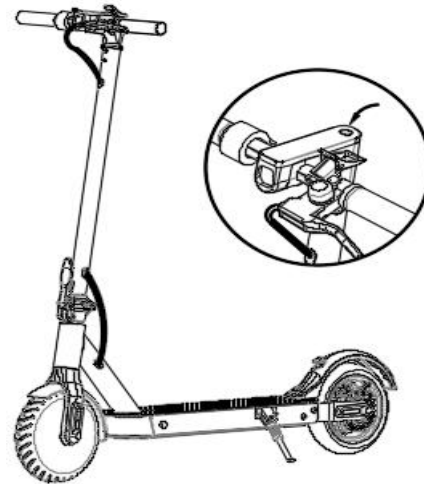

1. Turn on the power and check the power indicator

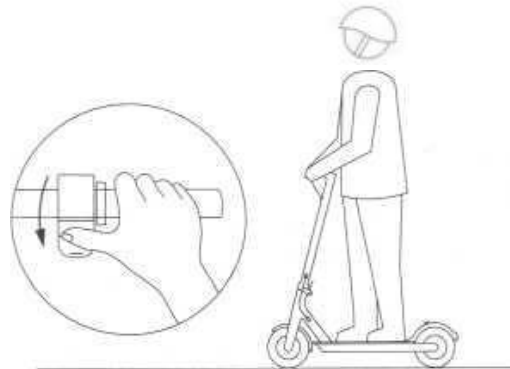

2. Single feet stand on the board, the other foot pedal back.

3. After electric scooter slide, the other foot pedal, when feet remain stable, tap the port finger (to be 5km / h above the speed will start the throttle

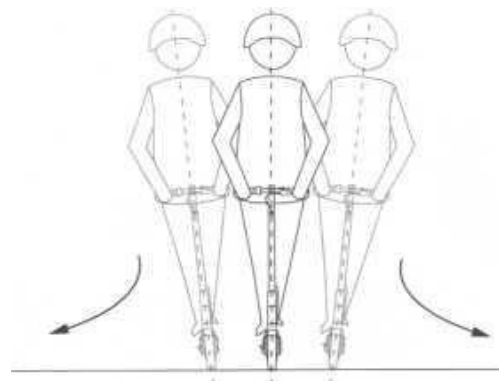
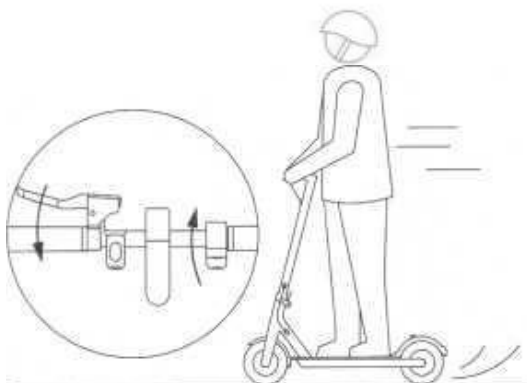

4. Release the throttle finger can slow deceleration, energy recovery system automatically open to help slow down, emergency brake need to shake the brake, handle at the front left handle.

5. When the focus is slightly tilted to the steering direction, and slowly turn the handle

6.Safety instructions

Avoid security risks

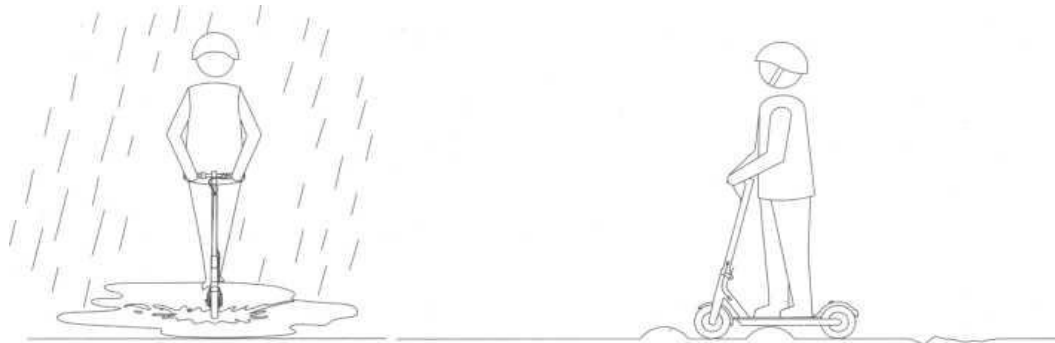

Please avoid riding in the rain



Encounter deceleration zone/elevator threshold/potholes and other unconventional road pavement, please do not pass at high-speed. Encounter rough road, please keep in the low speed (5-10km/h). A slight kneeling allows you to better adapt to the complex road

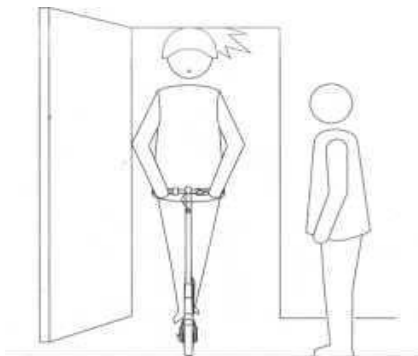

To avoid the head hit the door frame, elevators and other obstacles



Do not accelerate at downhill

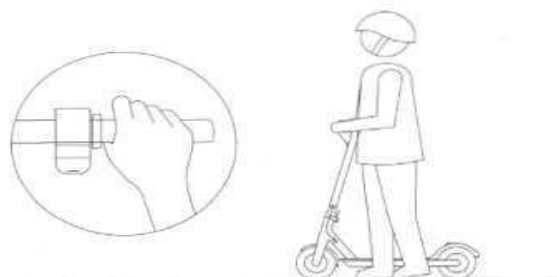

Do not press the throttle when walking



Please avoid obstacles to ride the electric scooter



Do not hang heavy objects such as backpack on the handlebar
Do not try the dangerous actions



Do not ride on the pedal or on the ground



Prohibit the ride electric scooter into the motor scooter lane and the car mixed with the residential

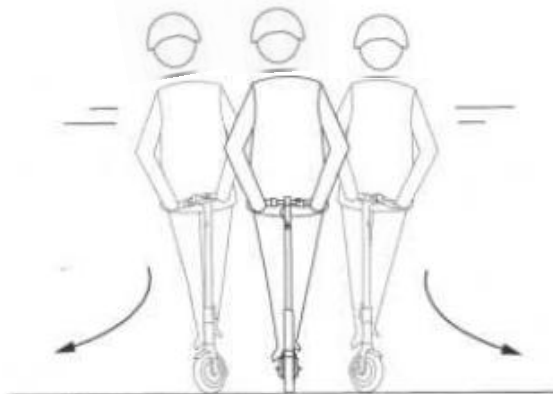

It is forbidden to turn the handle at high speed



It is forbidden to travel in more than 2cm-water

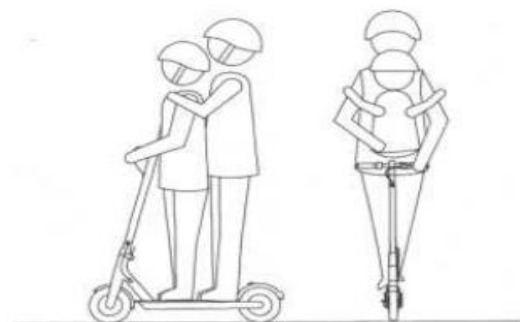

Prohibit many people at same time driving an electric scooter or driving with children



It is forbidden to step on the back of the fender

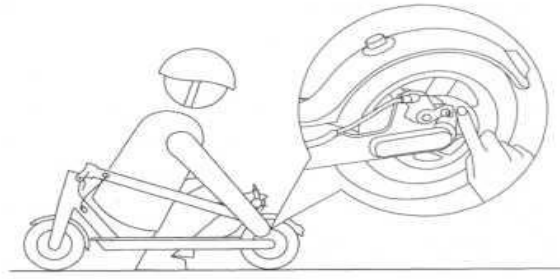

Do not touch the disc brakes

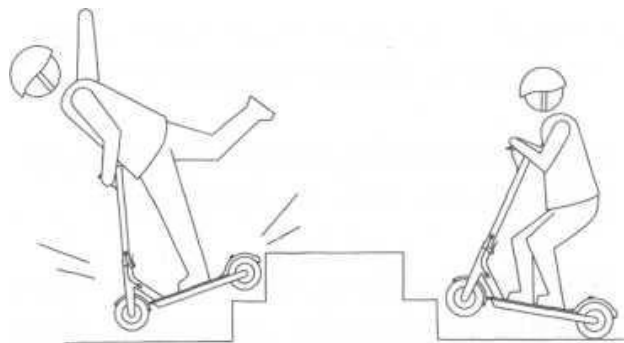

It is forbidden to not hold the handlebar when driving

Safety instructions

- An electric scooter is a sporting entertainment tool that is not a scooter, but once you drive it into a public area, it will also have a scooter property, so there are also possible safety risks for all modes of transport. Strictly following the instructions in this manual to drive for the maximum extent to protect you and the others's safety, and to ensure compliance with national and provincial traffic regulations and traffic regulations.
- At the same time, you need to understand: Once you have an electric scooter on a public road or other public place, you may be exposed to the risk of unauthorized driving/improper operation of others or scooters, even if you are in full compliance with this safe driving guide. Like walking or cycling may also be hurt by other means of transport. As with all scooters, the faster the electric scooter is driving, the longer the brakes need, and the emergency brakes on some smooth surfaces can also cause the wheels to slip and lose balance or even fall. Therefore, it is important to be vigilant and maintain the proper speed during driving, ad it is important to maintain a reasonable safety distance with others and the transport means. Please be vigilant and drive at low speed before entering unfamiliar terrain.
- Please respect the right of pedestrian way when driving. Avoid frightening pedestrians, especially the children. When pedestrians passing through, remind pedestrians and slowing down when passing. As far as possible from the left side of the pedestrian (applicable to the country where the scooter is traveling right). Face to face with pedestrians, keep on the right and lower speed.



It is forbidden to ride electric scooters upstairs and downstairs or jump obstacles

- We must strictly follow the safety requirements of this manual for drivers in countries and regions, where there are no national standards and regulations for electric scooters, such as in China. Millet Communications Co.,Ltd shall not be liable for any liability, personal injury, accident, legal dispute, and all other unfavorable events resulting from the use of violating the instructions indicated in this manual.
- Do not lend the electric scooter to a person who does not operate to avoid injury. If give the electric scooter to a friend, be sure to be responsible for the safety of your friends, you should teach him(her), and tell him(her) must wear safety care,.
- Please check the electric scooter for each time before driving. If you find that the parts are loose, the battery life is obviously reduced, the tire is slow to leak or excessive wear, turn to abnormal sound or malfunction, please stop using it immediately, and don not driving force. And call millet service number: 400-100-5678 for professional guidance or maintenance services.

7.Folding and transporting

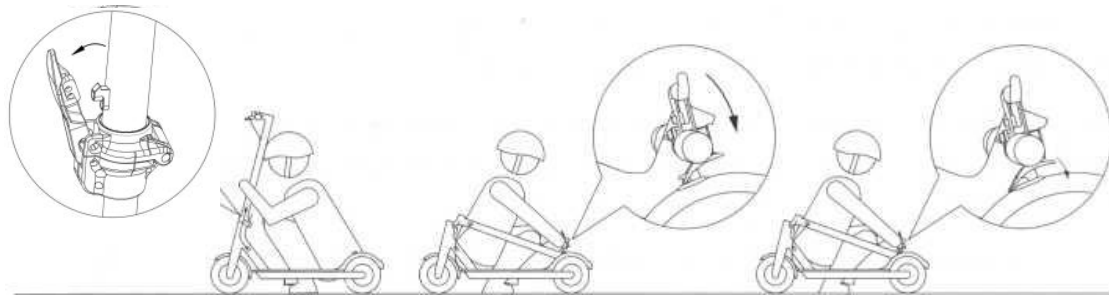

Make sure that the electric scooter is turned off, standpipe will dip through folding, open the folding wrench, and aim at the bell position and hook the bell with the rear mudguard. When opening you need to press the bell hook at the hook, until the bell hook is out of the stall after the hook, the vertical standpipe and lock folding plate back to fold.

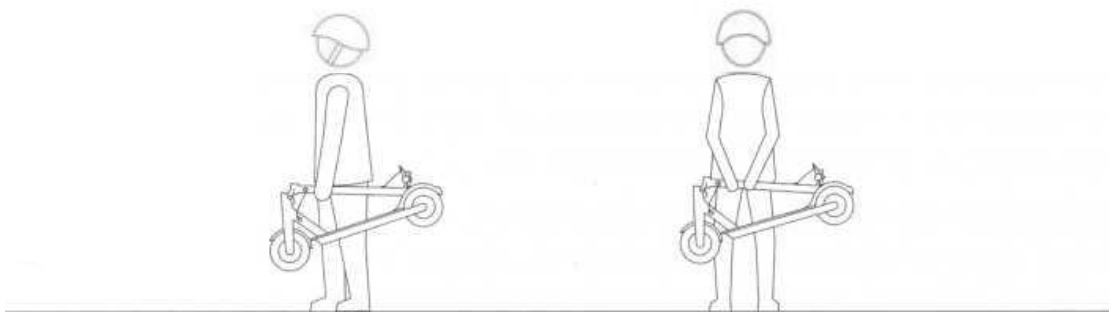

After folding, hold the standpipe with one hand or both hands to transport.

8.Daily maintenance

Electric scooter cleaning and storage

If the electric scooter body surface cracks, please use a soft cloth dipped in a small amount of water to wipe; if there is difficult to clean the dirty, you can use toothpaste and wash with a toothbrush repeatedly, and then use a

damp cloth to clean. If there are scratches in body plastic, you can use sandpaper or other grinding materials to polish.

Prompt: Do not use alcohol, gasoline, kerosene or other corrosive, volatile chemical solvent cleaning, otherwise it will seriously damage the appearance and internal structure of the body. It is forbidden to use a pressure water gun to spray and flush, and ensure that the electric scooter is closed all along and the charging cable has been unplugged and the rubber cap is tightened. Otherwise, it may cause electric shock or serious failure due to internal water intake.

When not in use, try to store electric scooters and tire aging and reduce the lift of electric scooters and their battery pack.

Electric scooter battery maintenance

1. Do not use other models or brands of batteries, or there may be a security risk.
2. Do not touch the battery contacts, and do not open or expose the shell. Avoid metal objects touching the battery contacts to cause a short circuit. Or it may cause damage to the battery or personal injury or death.
3. Only use the original charger to charge, otherwise there is a risk of damage or fire.
4. Improper disposal of used batteries may cause serious contamination of the environment. Observe local regulations when discarding this battery pack. Do not dispose of the battery pack, to protect the natural environment together.
5. After each use, please recharge the battery and then store, and it is conducive to extend battery life.

Do not place the battery in a high temperature environment higher than 50° C or below -20° C (for example, do not place the electric scooter or its battery pack put it under summer exposure in a car), and do not put a battery into a fire. Otherwise it may lead to battery failure, overheating, and even fire risk. When not using for more than 30 days, please be fully charged, stored in a cool dry place, and fully charged every 60 days, or it may damage the battery, and this damage is not within the warranty.

To avoid the full exhaustion of electricity and recharge, as far as possible with the charge with the use, which can greatly extend the battery life. In addition, at room temperature, the battery pack can play a higher mileage and performance; And if it is used in an environment below 0° C, battery life and performance will drop. Typically, at -20° C, the mileage may be only half or less at room temperature. And the temperature rises, the battery mileage will be restored.

Prompt: A fully charged electric scooter, depleting its stored power after about 120-180 days of standby. The battery inside has the smart chip to record the battery charge and discharge situation, and prolonged non-charging damage will not be recharged, at this time if not timely charging, it is likely to lead to excessive battery discharge damage, this damage is irreversible, and can not enjoy free warranty. (Note: Non-professional personnel is prohibited to the remove the battery pack, or it may be lead to serious security incidents due to electric shock or short circuit!)

Disc brakes debugging

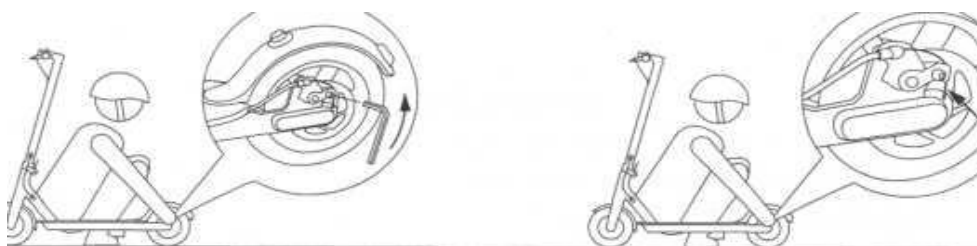

If you feel the brakes are too tight, please use the M5 hex wrench counterclockwise to release the pressure plate screws on the disc brake seat, return the brake line to make the exposed tail length slightly shorter, and lock the pressure plate screws; If you feel the brake is too loose, release the

pressure plate screws, drag the brake cable to make the exposed tail length slightly longer, and then lock the pressure plate screws.

Handle shake

debugging

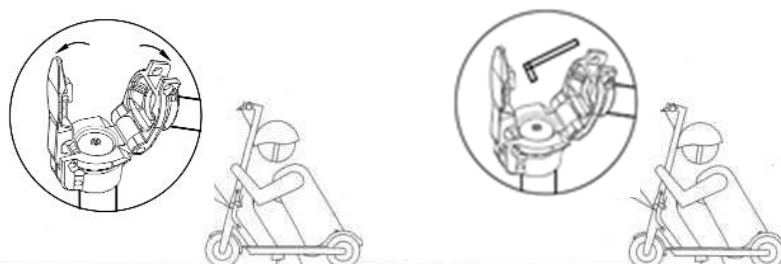

If your standpipe in electric scooter is shaking, please use the M5 hex wrench to lock the two screws at the fold mechanism.

Extend the use of inflatable mouth

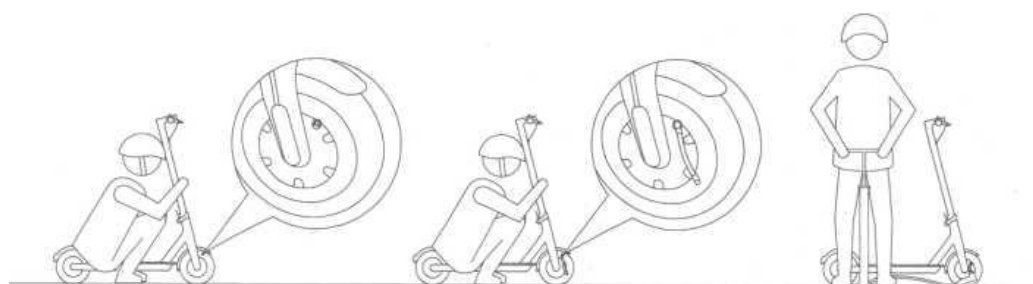

If your electric scooter front and rear tires are deficiency, please use the extended inflatable mouth to connect the scooter body tires to cheer. First remove the front and rear tire inflatable mouth cup, and then tighten the extension of the inflatable mouth and tire inflatable mouth, and connect the pump to inflate after they are to be tightened

9.Model parameter table

Performance index	Item	Parameters
Product dimensions	Unfolding: Length x Width x Height	1080 x 440 x 1100 mm
	Folding: Length x Width x Height	1080 x 440 x 500 mm
Product weight	Weight	13KG
Riding requirements	Max loading	120KG
	Applicable age	14-50 years old
	Applicable height	120-200cm
Main parameters	Max speed	25KM/H
	Range (km)	18-28KM(depends on battery capacity)
	Climbing ability	$\cong 15^\circ$
	Applicable terrain	Flat dirt road, no higher than 1cm steps, no more than 3cm wide channel
	Working temperature ° C	-10~40

	Storage temperature ° C	-20~45
Battery parameter	Rated Voltage (VDC)	36V
	Max charging voltage (VDC)	42V
	Rated power (W)	350W
Motor parameter	Max power (W)	540W
	Rated power (W)	350W
	Rated input voltage (VAC)	110-240V
	Rated output voltage (VDC)	42V
	Rated current (A)	1.7V
	Charging time	4-5H

- (1) Body height: the distance from the ground to the top of its body.
- (2) Typical life: When the electric scooter is full, 75kg load, 25 degrees Celsius, flat road without wind environment, in the energy-saving mode to keep at 20km/h even speed conditions measured, the actual life due to load, temperature, wind speed, road and operating habits and other factors to be different.

Note: Data and parameters vary with different models. Subject to change without notice.

10.Name and content of harmful substances in the product

Name of component	Harmful substance					
	Plumbum (Pb)	Mercury (Hg)	Cadmium (Cd)	Hexavalent chromium (Cr(VI))	Polybrominated Biphenyls (PBB)	Polybrominated Diphenyl ethers (PBDE)
Charger	X	O	O	O	O	O
Battery	X	O	O	O	O	O
Air tap	X	O	O	O	O	O
Charging port	X	O	O	O	O	O
Master Control board	X	O	O	O	O	O
Instrumentation circuit board	X	O	O	O	O	O
Wheel motor	X	O	O	O	O	O
Scooter frame	O	O	O	O	O	O

Tire	O	O	O	O	O	O
<p>This table is formulated in line with the SJ/11364.</p> <p>O: Indicate that the content of this harmful substance in all homogeneous materials of this components is below the limit prescribed in GB/T 26572</p> <p>X: Indicate that the content of this harmful substance in at least one homogeneous materials of this components is beyond the limit prescribed in GB/T 26572</p>						

11. Warranty policy

Electric scooter after-sales service is strictly based on the *People's Republic of China Consumer Protection Law* and *People's Republic of China Product Quality Law* to implement the three-guarantee service, the service content is as follows:

I. The warranty period

- 7 days from the date of signing, the product appears *Electric Scooter Performance Fault Table* listed in the performance fault situation, through the millet service center test to determine that is free to enjoy the return or replacement service;
- 8 - 15 days from the date of your signing, the product appears *Electric Scooter Performance Fault Table* listed in the performance fault situation, through the millet service center test to determine that is free to enjoy the replacement or repair service;
- 12 months from the date of your signing, the product appears *Electric Scooter Performance Fault Table* listed in the performance fault situation, through the millet service center test to determine that is free to enjoy the replacement service;

Friendly tips: It is advisable to keep the packing box for at least 15 days from the date of receipt of the shipping container, because of using packing boxes to ensure the safe Transportation of the product at the process to transporting.

II. The warranty content

Category	Maintenance contents	Starting time
Machine body	Frame assembly, wheel drive, controller assembly, handlebar, forehead main body, middle tank instrument board, rear wheel, brake disc, disc brake assembly, folding handle, front fork, front fork tube rotating parts, the control bus and brake line	One year
Accessories	Battery charger, brake and finger, switch	Six months
Wearing parts of appearance	Anti-collision strip, headlight assembly, instrument cover, tires, outer tubes, inner tubes, bell components, fender, rear taillights, decorative cover, foot support components, battery compartment, cover, foot pad, charging port seat and rubber stopper	Three months

Notes: Socket head wrench and extended inflatable mouth as the product random supplies, and it has no warranty period.

III. Non-warranty regulations

1. Unauthorized repair, misuse, collision, negligence, abuse, infusion, accident, alteration, improper use of non-product accessories or torn, altered label and anti-counterfeit mark;
2. Has been beyond the period of validity of the three guarantees;
3. Any damage is caused by force majeure;
4. Does not conform to the listed performance situation in the Performance Fault list of Electric Scooter Performance Table;
Electric scooter;
5. Due to man-made causes of this product and its accessories produce listed performance fault in the Electric Scooter Performance Table;
6. Damage caused by man-made reasons (including but not limited to the liquid entering into scooters, puncture, impact, the traces and damage of the normal use of the appearance, ect.):
7. If the product is used for commercial use, it is not guaranteed.

IV. The performance fault table of electric scooters

Designation	Performance faults
Electric scooter	Under normal use, the motor cannot work Under normal use, the controller appears a failure Under normal use, battery appears failure Under normal use, appearing deformation, break can not continue to use