



UREVO STROL LITE 2-IN-1 UNDER DESK TREADMILL

MAKING FITNESS FUN
UR9TM0011

USER MANUAL



CONTENT

- 02 SERVICE
- 03 IMPORTANT SAFETY GUIDELINES
- 04 PARTS LIST
- 04 TECHNICAL PARAMETERS
- 05 PRODUCT STRUCTURE
- 06 ASSEMBLY
- 08 CONSOLE
- 09 REMOTE CONTROL GUIDELINES
- 12 BATTERY REPLACEMENT
- 13 ADJUSTMENT OF RUNNING BELT
- 15 LUBRICATING
- 16 TROUBLESHOOTING
- 17 WARRANTY

IMPORTANT: FOR UREVO ONLY

For damaged or defective product, questions, replacement parts or any other service support, please contact our customer service department by the below methods:

For The Best Service, Email us with order ID at:

US: Services@urevosports.com

WALMART: service_walmart@urevosports.com

Response Time: 1-2 Business Days

Emailing us with the information above will be the best method to receive a response during peak business hours.

Website: www.urevosports.com

PLEASE DO NOT RETURN THIS PRODUCT TO THE STORE.

Scan this QR Code to get the Product Installation Guide





IMPORTANT SAFETY GUIDELINES



Please carefully read this manual before use to ensure your safety and avoid accidents.

- This product is home fitness equipment. Do not modify it for other purposes or outdoor use. The walking machine should be placed on clean and flat ground rather than thick carpet or near water with a 3-6 ft safe area free from any obstacles behind it.
- This product is intended for adults. Minors should be accompanied by adults when using it. Persons who are indisposed, mentally disabled or lack common sense are not allowed to use it. They can use it under the supervision and guidance of persons responsible for their safety.
- Damaged power cord must be replaced by the manufacturer or professional maintenance personnel to avoid danger.
- This product only works under 100V-120VAC voltage. Be sure to use a power socket with safety ground. The grounding plug must be installed and grounded according to the parameters specified locally. If the plug does not match the socket, ask qualified electricians or after-sales staff to handle it.
- Check all parts before use to ensure the screws and nuts are tightened.
- Wear tight fitting clothes to prevent clothes from being caught by the machine when using it. Keep children or pets away from the machine to avoid accidents.
- Avoid touching any moving parts with hands. Do not place your hands and feet in the space under the running belt.
- This product is suitable for home use rather than professional training and testing, nor medical purposes.
- The indication of heart rates on the product does not serve as data for clinical medicine.
- Only one person can use this product when it is in operation.
- Power off and unplug before cleaning and maintenance.
- Power off and unplug when you leave.
- Please use the original accessories. Do not make any replacements without permission.
- **The maximum weight capacity for this product is 265 lbs / 120 kg. DO NOT EXCEED MAXIMUM WEIGHT CAPACITY.**
- **Please make sure to add 10ml of lubricant to the lubrication port when using the product for the first time. Add lubricating oil every 3 months or after 100 miles of working.**

PACKAGE LIST

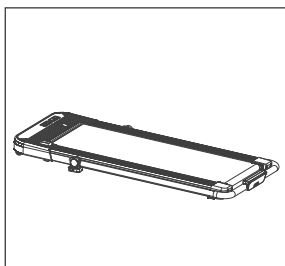

Walking machine × 1

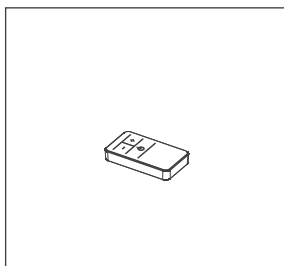

Remote control × 1

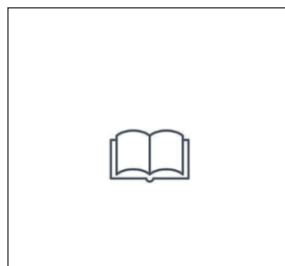

Manual & Warranty card × 1

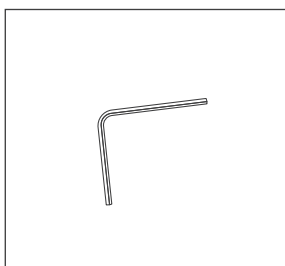

Allen wrench × 1

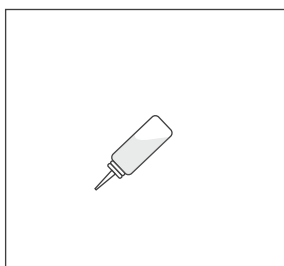

Silicone oil × 1

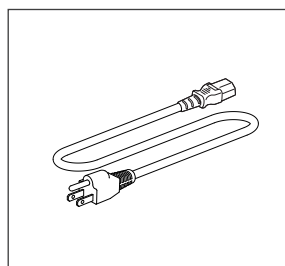

Power Cord × 1

TECHNICAL PARAMETERS

Product configuration	Technical parameter
Input voltage	100 ~ 120VAC
Packaging size	57.1 x 28.9 x 5.9 inch
Folding size	54.7 x 26.4 x 5.1 inch
Assembly size	52.6 x 26.4 x 39.7 inch
Running area	16.9 x 42.5 inch
Rated power	550 W
Range of speed	0.6 - 7.6 MPH
Maximum load bearing	265 LBS
Net / Gross weight	57.3 / 68.4 LBS

PRODUCT STRUCTURE

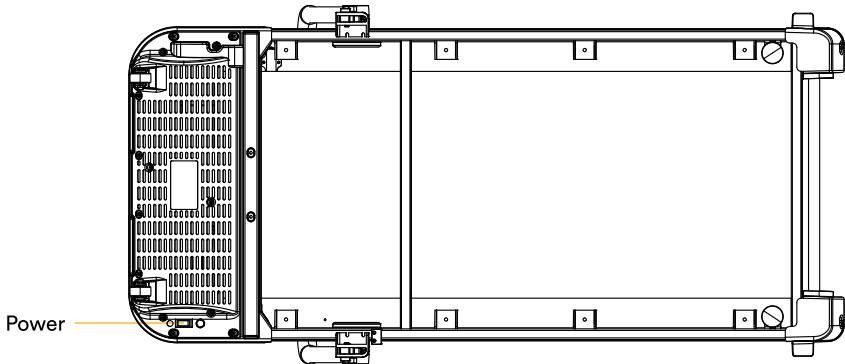
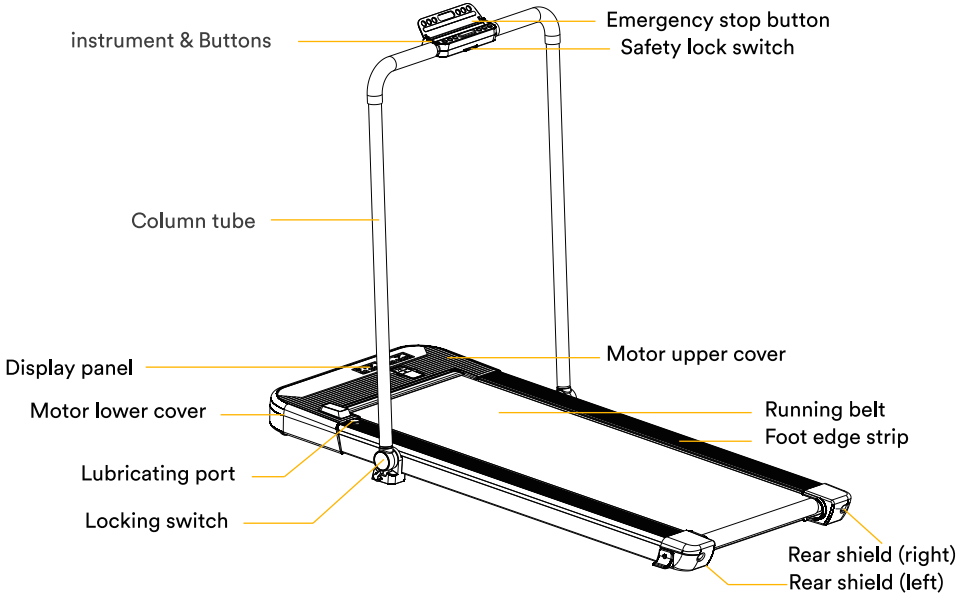

ASSEMBLY STEPS

1. Open the packaging box and take out the related accessories and the machine from the box.
Place the machine on the flat ground.
2. Lift and push the column tube upwards until it stops moving.
3. Hold the column tube with one hand and turn the locking switch to the OFF position with the other hand (the same operation on both sides).
4. The column tubes are fixed. Then the assembly of the machine is completed.

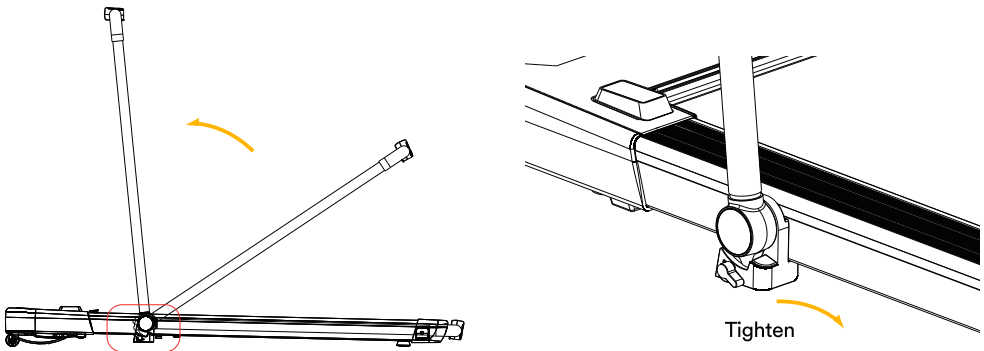

5. Connect the Power cord to the machine.

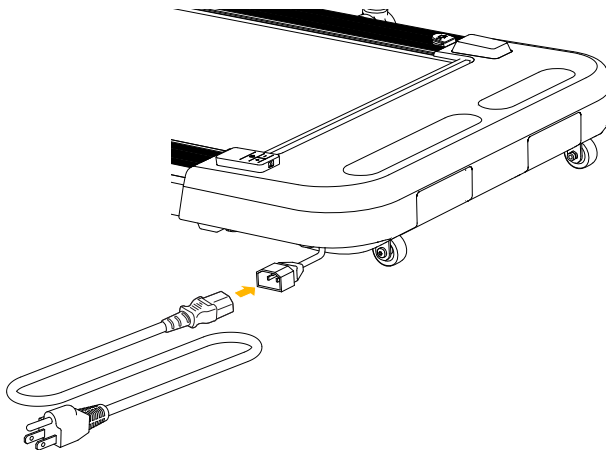

6. Plug in the power cord and turn on the Power.

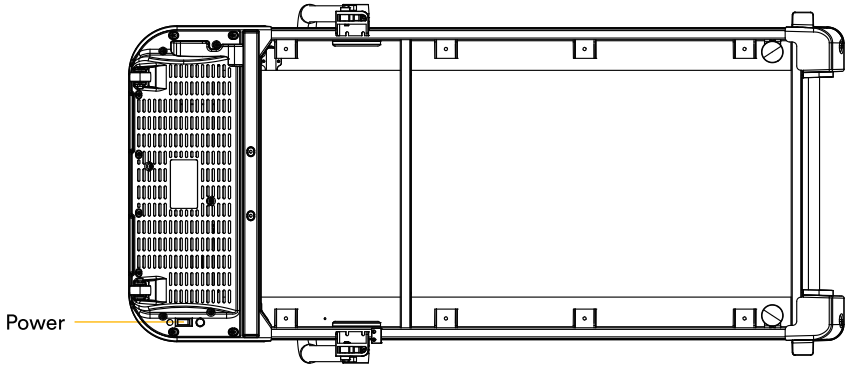

FOLDING STEPS

1. Hold the column tube with one hand and turn the locking switch to the ON position with the other hand (the same operation on both sides).
2. Hold and lower the column tube until it is placed flat.
3. The folding of the machine is completed.

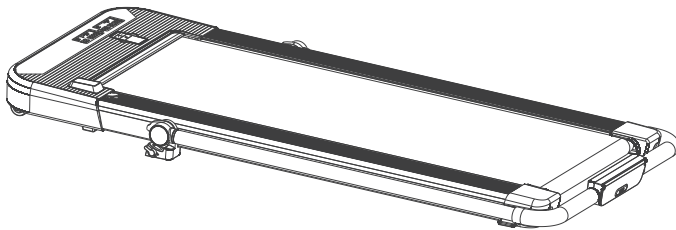

NOTE: Make sure the power is turned off and the power plug is removed from the socket.

SCREEN

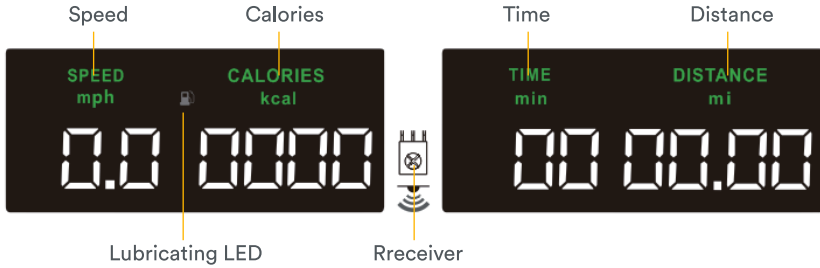

OPERATION INSTRUCTIONS

1. Start/Stop and Add/Reduce keys on the remote control or keyboard.
2. Emergency stop switch (STOP).
3. Pause in operation.
4. Speed: 0.6-7.6 mph;
Calories: 0001-9999KCAL;
Time: 01-99 minutes;
Distance: 00.00-99.99miles.
5. Sleep time in standby: 5 minutes. The screen turns off after sleep.
6. Lubricating prompt: every 100 miles.

REMOTE CONTROL GUIDELINES

REMOTE CONTROL PANEL

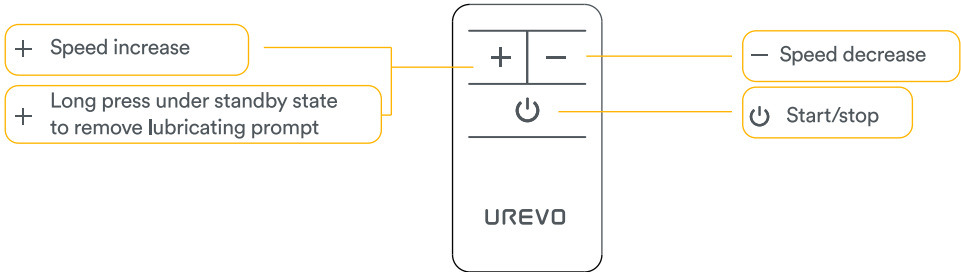

OPERATION OF REMOTE CONTROL

- Power button:** In standby mode, press the power button and the machine runs at the speed of 0.6 mph. Press the power button again and the machine stops. (i.e. another start/stop cycle begins)
- +** key: Each time when you press the "+" key during operation, the speed per hour will be increased by 0.2 miles; long press the "+" key to continuously increase the speed by 0.2 miles. Additional function: Press the "+" key for 10 seconds to clear the lubricating icon when the machine is in standby mode.
- key: Each time when you press the "-" key during operation, the speed per hour will be decreased by 0.2 miles; long press the "-" key to continuously decrease the speed by 0.2 miles.

Note: The speed can only be increased up to 3.8 mph via the remote control. To increase to 7.6 mph, you need to press "+" key on the keyboard.

Note: Make sure that the safety lock switch of the instrument is magnetically on before use, otherwise the machine cannot be started.

1. After power-on, the digital tube lights on both sides flash from outside to inside and bottom to top, then the machine enters the standby state.



2. Aim the remote control at the signal receiver of the display screen, and press the power button on the remote control. The digital tube lights on the display show three bars from bottom to top. The machine starts running at the speed of 0.6 mph.

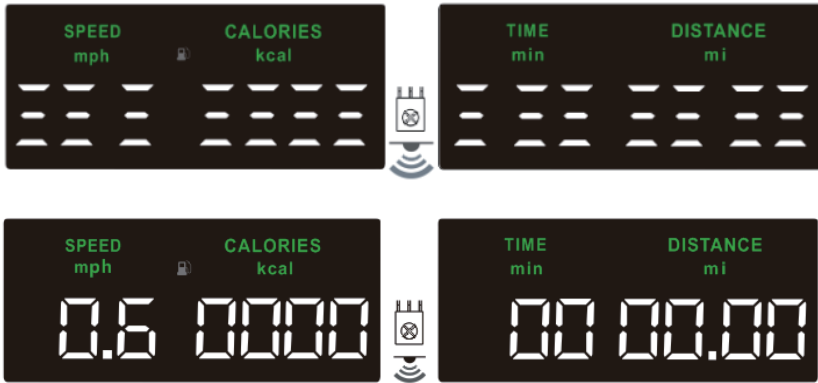

SPEED CONTROL

Each time when you press the “+” key on the remote control (or the instrument) during operation, the speed per hour will be increased by 0.2 miles; long press the “+” key to continuously increase the speed by 0.2 miles.

Each time when you press the “-” key on the remote control (or the instrument) during operation, the speed per hour will be decreased by 0.2 miles; long press the “-” key to continuously decrease the speed by 0.2 miles.







During operation, press the 3 shortcut key on the instrument, and the machine runs at the speed of 3 mph; press the 6 shortcut key on the instrument, and the machine runs at the speed of 6 mph.

STOP

1. During operation, press the  key on the remote control (or **STOP** key on the instrument), and the machine stops running.
2. After continuously running for 99 minutes, the machine stops automatically.

OPERATION OF INSTRUMENT





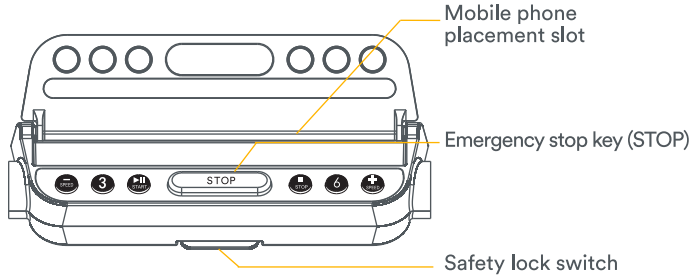







Function description of keys

-  Reduce key
-  3 mph
-  Start/Pause
-  Stop
-  6 mph
-  Add key



Note: You can start the machine only after turning on the safety lock switch; when the safety lock switch is not on, the STOP word keeps flashing.

FUNCTIONS/OPERATION INSTRUCTIONS

-  key: In standby mode, press  key and the machine runs at the speed of 0.6 mph. Press  key again the machine pauses. During pause, the  key light keeps flashing. (i.e. another Start/Pause cycle begins, and current data can be saved during pause).
-  key: In operation mode, press the  key and the machine slowly stops running.
-  Key: In operation mode, press the  key, the STOP word flashes, all key lights are off, and a bar appears on the display panel. The machine stops within 6 seconds.
-   shortcut keys: In operation mode, press the “3” key and the machine runs at the speed of 3 mph by slow increase (or decrease) from the current speed. The operation on reaching the speed of 6 mph is the same as that of reaching the speed of 3 mph.
-   keys: In operation mode, press the keys to increase or decrease the speed.

BATTERY REPLACEMENT

1. Removing insulating paper from the remote control before use:

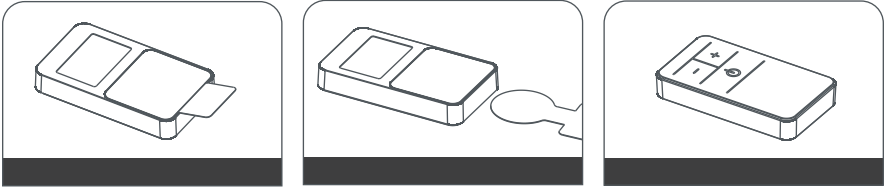

Prepare to remove the insulating paper. Pull out the insulating paper. Available status.

2. Replacement of button battery of the remote control:

The remote control would present less sensitivity or cannot be operated due to low battery after having been used for a long time, the battery of the remote control needs to be replaced.

Removing the battery:

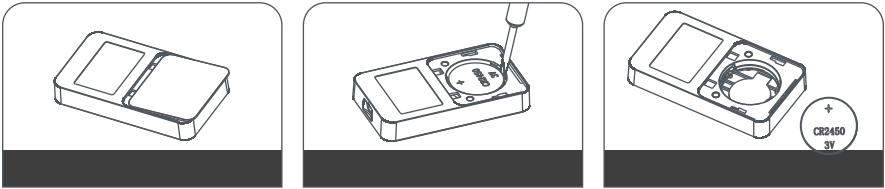

Push the battery cover backward and lift it. Remove the battery with a slotted screwdriver. Take out the battery.

Installing the battery

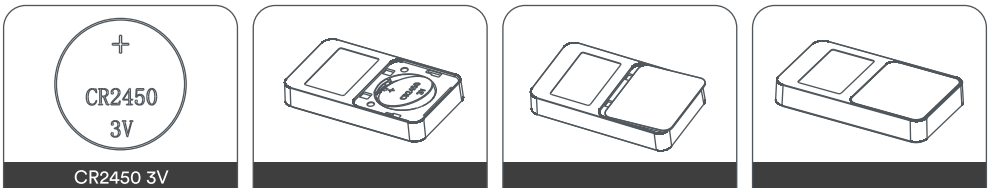

Battery specifications
Battery installation

with (+) pole facing up

Close the battery cover
and push it forward,
then press it down.

Battery installation
completed

ADJUSTMENT OF RUNNING BELT

Moving to the left

Adjustment: Turn off the power. Clockwise rotate the bolt of the left rear roller by 1/4 turn with the 5mm Allen wrench to tighten the running belt. Then power on the machine and test whether the running belt is centered. Adjust the running belt with this method until it is centered.

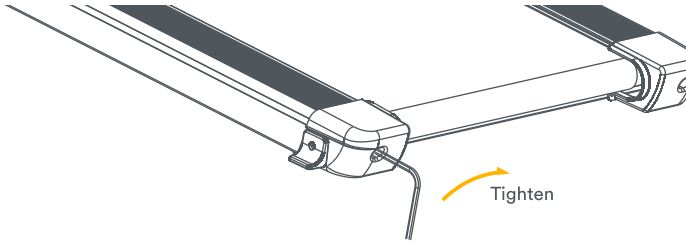

Moving to the right

Adjustment: Turn off the power. Clockwise rotate the bolt of the right rear roller by 1/4 turn with the 5mm Allen wrench to tighten the running belt. Then power on the machine and test whether the running belt is centered. Adjust the running belt with this method until it is centered.

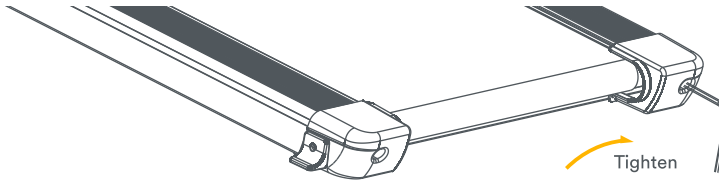

The running belt will be loose after being used for a period of time. Loose running belt will slip during use.

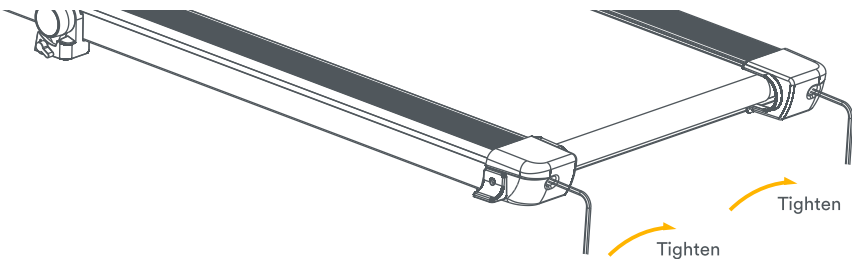

BATTERY REPLACEMENT

Adjustment: Turn off the power. Clockwise rotate the bolts of the left and right rear rollers by 1/4 turn simultaneously with the 5mm Allen wrench to tighten the running belt. Then power on the machine and test the tightness of the running belt. Adjust the running belt with this method until its tightness is appropriate.

Note: When you are running on the walking machine, the pressure on the running belt is imbalanced as the force applied by your feet on the belt is different, which will deviate the running belt from the center. Such deviation is normal and the running belt will return to the center if no one runs on it.

The running belt cannot be tightened too much. Failure to do so may damage the running belt, the roller bearings, etc., increase the pressure on the front/rear rollers, and cause abnormal noise or other problems.

The walking machine has been lubricated before shipment. However, the rubbing between the running belt and the running board greatly affects the service life and performance of the product, so you must add lubricating oil according to the instructions of the machine. When the walking machine has run a distance of 100 miles, a red indicator will appear on the display for lubricating.

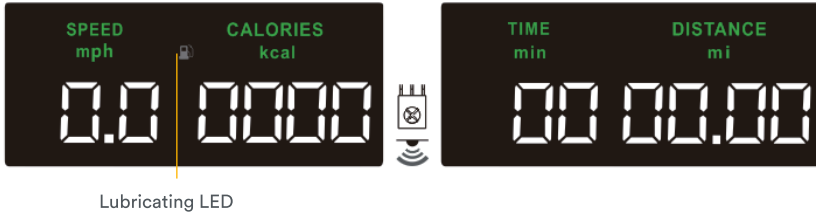

Note: Use special lubricant of walking machine or contact our company directly.

LUBRICATING OPERATION

Please make sure to add 10ml of lubricant to the lubrication port when using the product for the first time. Add lubricating oil every 3 months or after 100 miles of working.

- Cut off the seal inside the oil bottle, and cut a small opening on the oil bottle cap (for easy squeezing out oil);
- Turn up the oil filler plug;
- Adjust the speed of the machine to 0.6 mph. Align the bottle opening to the lubricating guide hole and properly squeeze oil by about 10ml each time;
- After adding silicone oil, run the machine for about 3 minutes. When the silicone oil covers the running belt evenly, press the key on the remote control (or the  key on the instrument) to stop it. Then press the “+” key on the remote control for 10 seconds (or press the “+” and 6 keys on the keyboard simultaneously for 10 seconds) to remove the lubricating LED icon. The lubricating is completed.

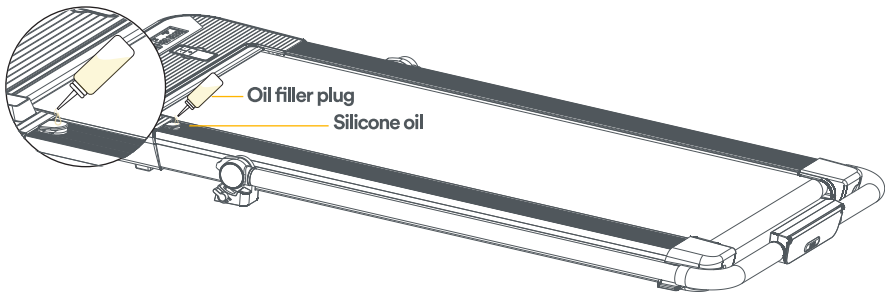

Note: Be careful during lubricating operation. Do not touch the moving parts.

Code	Causes	Resolutions
E01	Poor communication between electric meter and controller	<ol style="list-style-type: none"> 1. Check whether the electric meter is properly connected to the controller. 2. Reinsert the main IC of the controller as it is in poor contact. 3. Replace the controller as its power supply is abnormal.
E02	Explosion protection	<ol style="list-style-type: none"> 1. Replace the motor or check the connection terminal as motor open circuit or contact fails. 2. Replace the power tube or controller as power tube is damaged.
E05	Overcurrent protection	<ol style="list-style-type: none"> 1. Overload 2. Add lubricating oil as the resistance on the running belt is high. 3. Replace damaged motor.
E06	Overload protection	
E10	Failure in communication between keyboard and panel control.	<ol style="list-style-type: none"> 1. Check whether the electric meter is properly connected to the controller. 2. Reinsert the plug of the controller as it is in poor contact. 3. Replace the controller as its power supply is abnormal.

MANUFACTURER'S LIMITED WARRANTY

UREVO warrants to the original purchaser that this product is free from defects in material and workmanship when used for the purpose intended, under the conditions that it has been installed and operated in accordance with UREVO Owner's Manual. UREVO 's obligation under this warranty applies to the following:

COMPONENT LENGTH OF WARRANTY

Structural Frame 1 year For Home Use Only

All Other Components 90 days For Home Use Only

Exclusions from Warranty Coverage:

UREVO does not warrant against and is not responsible for, and no implied warranty shall be deemed to cover, any product failure, product malfunction, or damages attributable to:

1. Improper installation and/or failure to abide by UREVO 's installation guidelines;
2. Use of this product beyond normal home use, or in an application for which it was not designed;
3. Cosmetic items such as scratches, dents or discolorations;
4. Damage caused by normal wear and tear, vandalism, accidental or by animals;
5. Any act of Nature (such as fire, flooding, snow, ice, hurricane, earthquake, lightning or other natural disaster), environmental condition (such as air pollution, mold, mildew, etc.), or staining from foreign substances (such as dirt, grease, oil, etc.);
6. Normal weathering due to exposure to sunlight, weather and atmosphere which can cause colored surfaces to among other things, flake, chalk, accumulate dirt or stains.
7. Improper operation, alteration, handling, storage, abuse or neglect of the products.

UREVO , using its sole discretion, will either repair or replace free of charge any part(s) proven to be defective under normal home use. Any repair or replacement shall provide no new warranty coverage, but shall retain only the remaining portion of the original product's warranty. This warranty is offered only to the original purchaser and is not transferable. Proof of original purchase is required.

Replacement parts can be ordered by emailing our customer service department:

US: Services@urevosports.com

WALMART: service_walmart@urevosports.com

Open Monday thru Friday 8:00 AM - 5:00 PM (PST).

When ordering replacement parts please have the following information ready:

1. Order Number
2. Description of Parts(Add photos or videos would be helpful)
3. Part Number
4. Date of Purchase



IMPORTANT: Read all instructions carefully before using this product. Retain this owner's manual for future reference. The specifications of this product may vary from this photo, subject to change without notice.

Manufacturer: Shanghai Runmi Technology Co., Ltd.

Address: 15th Floor, Building 21B, No.1158, Zhongxin Rd, Songjiang district, Shanghai, P.R.China



MADE IN CHINA