



Gyrocopters Pro 6.0

User manual



Before You Begin-----01



Main Components-----02



Charging Your Batteries-----03



Powering on the Scooter-----04



Indicator Lights -----05



Pairing your Bluetooth Device ----06



Riding Your Scooter-----07-10



Mobile App -----11



Safety Alerts-----12



Driving Safety-----13-16



Technical Specifications-----17



Battery Safety-----18-19



Warranty Details ----- 20



Before You Begin

Before learning to ride your scooter, you must read and follow all instructions and warnings in this user manual. It is important that you follow all safety warnings and cautions that appear throughout the user manual and that you use good judgment when you ride your scooter.

The Risk of injury

The scooter is a self-balancing, personal scooter that uses balancing technology. Balancing technology cannot prevent injury if you do not ride the scooter safely. Whenever you ride the scooter, you may be at risk for serious injuries from loss of control, collisions, and falls. To reduce your risk of injury, you must read and follow all instructions and warnings in this user manual.

Disposal and Storage

Dispose of according to local laws.

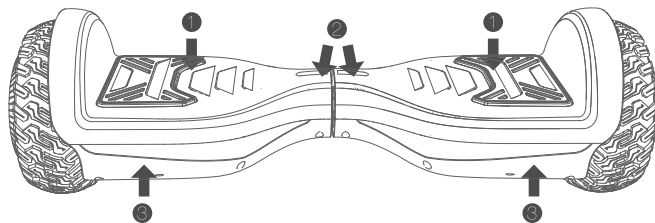

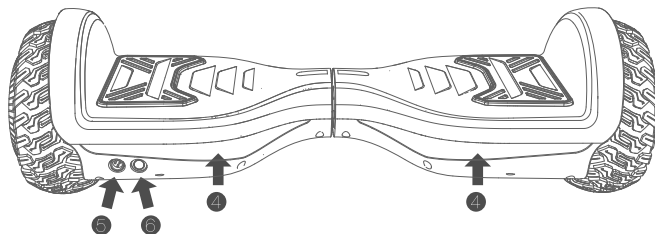

- ① Foot Mat
- ② Indicator Lights
- ③ Headlights

- Brake Lights ④
- Power Button ⑤
- Charging Port ⑥

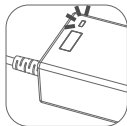
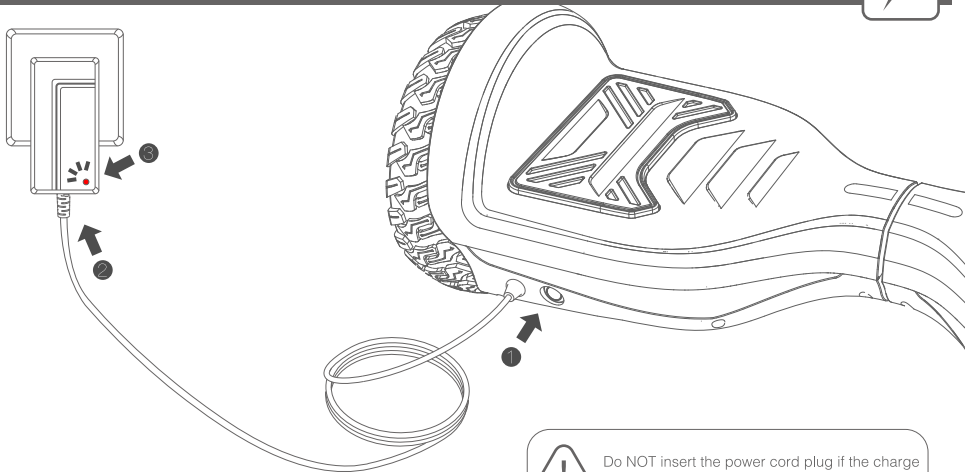



Battery Charge Indicator Light

- "  " When scooter is plugged in and charging, battery charge indicator will be solid red
- "  " If battery charge indicator is green, the batteries are fully charged



Do NOT insert the power cord plug if the charge port, power cord or AC power outlet is wet.

Model AOI-08420150DD1 manufactured by DONGGUAN AOI ELECTRONIC TECHNOLOGY
CO LTD Input 100-240Vac, 50/60Hz, Output: 42Vdc, 1A



Powering On the Scooter

Power on your scooter by pressing the Power button. The Power button is located on the back side of the scooter. The indicator lights will illuminate to indicate the power is ON.

Resetting the Scooter

1. Turn off the hoverboard
2. Place the hoverboard on top of a flat surface in a way so the wheels aren't touching the surface (not upside down)
3. Ensure the center part of the board is completely straight and aligned
4. Press and keep holding power button for 20 seconds. You will notice that hoverboard will beep and lights will flash
5. After 1st set of 20 seconds, let go of the power button but let the hoverboard continue to beep and flash for 20 seconds
6. After 2nd set of 20 seconds, turn off the hoverboard.
7. Place it back on the floor. Turn it on and give it a try

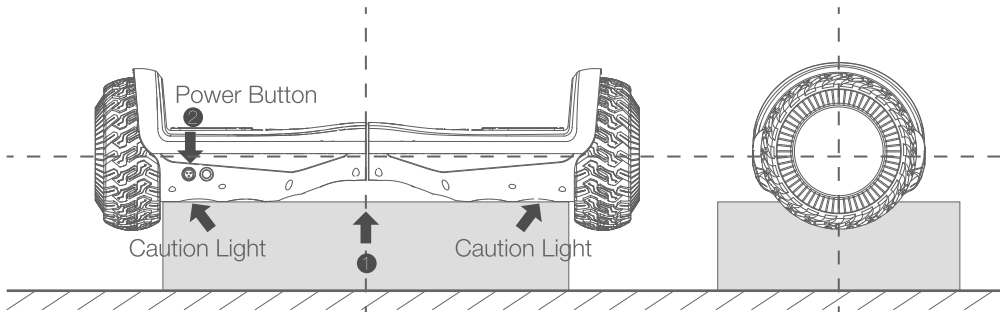

Indicator Lights

① Warning Indicator Light (Red)

If red warning lights are flashing, there is an issue with the scooter (over speed, balance issue, power issue, etc)

② Balance Indicator Light (Green)

The scooter is in Balance Mode when the green light is on

③ Battery Status Indicator Light (Green)

When turned on, the battery status indicator light will be solid green. This means it is charged more than 20% and can be used

④ Battery Level Indicator Lights (Red)

If the light is red, charge immediately because the battery is less than 20%

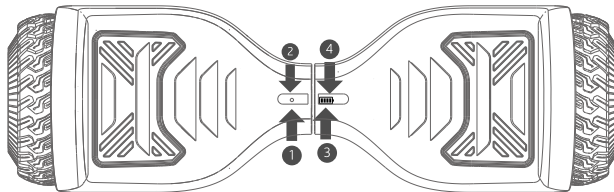



To pair with a Bluetooth® device follow these steps:

- 1 Make sure both the Bluetooth® function in your device and the scooter are turned on.
- 2 Open the scooter APP on your device to connect wirelessly to the scooter.
- 3 On your device, locate the Bluetooth® device list. Select “GYROCOPTERS” from the list .

Resetting Bluetooth® Memory

To reset Bluetooth® Memory, resetting the scooter is needed, Refer to **Resetting the scooter** (page 4).

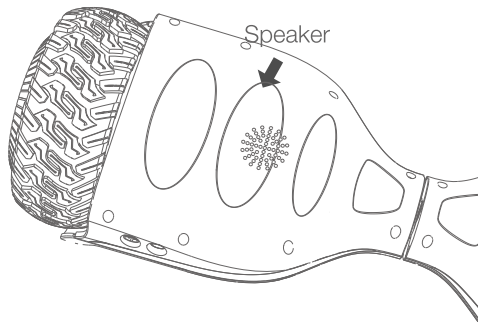



Before riding, make sure your scooter is fully assembled and charged, inspect your scooter before each use. Do not ride if any part is loose or damaged.

The scooter is highly maneuverable and allows you to easily navigate around obstacles. However, to prevent the loss of traction, you must always be careful when riding and learn to identify and avoid unsafe surfaces. Slippery, icy, or wet surfaces, loose materials (sand/gravel), steep slopes, and obstacles might affect the scooter's performance.

Familiarize yourself with the indicator lights that may be displayed on the scooter.

Step 1. Power ON the Scooter by pressing the power button, make sure the Battery Status Indicator light is on.

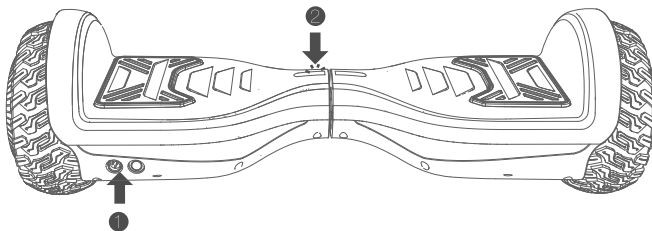



NOTE: The Scooter comes with the No-Fall Technology mode turned on. This feature keeps the board upright whether you are standing on it or not. To turn off this feature, make sure the scooter is off. Now double click the power button when turning it on (quickly tap twice). You will hear the normal power-on beep tone, followed by a longer beep tone. The No-Fall Technology mode is now turned off.

Step 2: Getting on the Scooter

- 1 Place one foot on the foot mat
- 2 The Balance indicator light will turn ON enabling the automatic balancing system.
- 3 Try to keep the scooter steady and leveled.
- 4 Place your other foot on the other foot mat

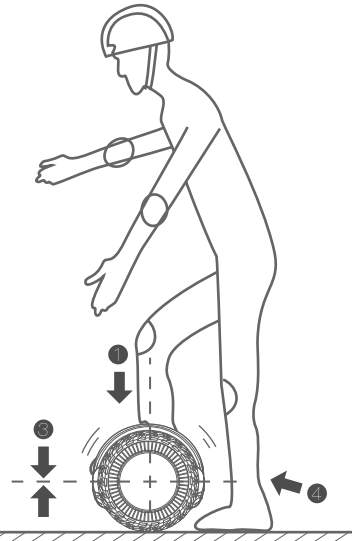
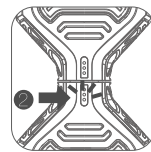



Step 3: Moving forward and backwards

- 1 Keep the scooter still by remaining level when standing on it.
- 2 SLIGHTLY lean your body forward or backward to enable the scooter to move forward or backwards respectively.

NOTE: When the scooter is unable to achieve a balanced position, an alarm will sound and trigger the Warning Indicator light. The scooter will return to a balanced position automatically. During this process, you should not step or ride the scooter.

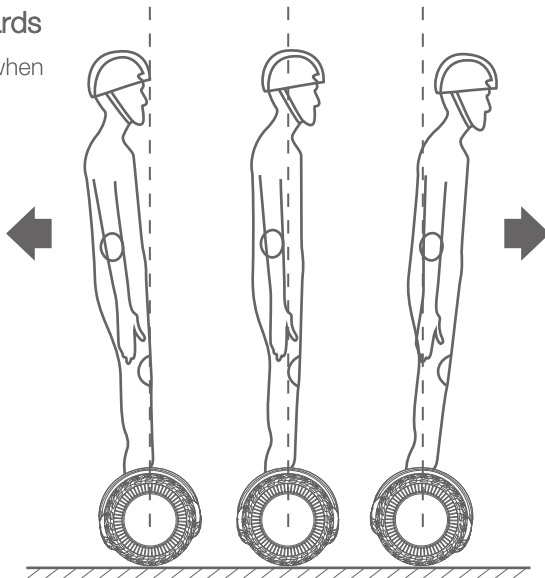

- Body leaning should be done in small increments. Only small leaning angles are needed to drive the scooter forward or backwards.
- Leaning forward or backwards too much can affect riding safely.

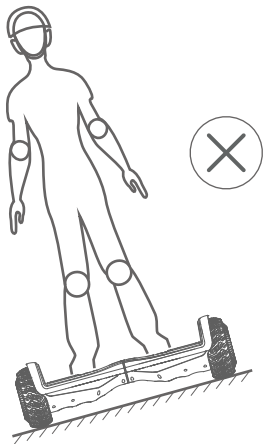

Step 4: Steering the Scooter

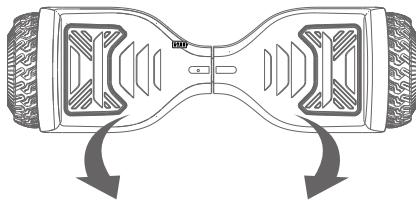

Press right foot forward
to turn left

Press left foot forward
to turn right

Step 5: Getting off the Scooter

Make sure the scooter has completely stopped and is stable before stepping off. Step off the scooter one foot at a time.



- Do not turn while in high speeds to avoid dangerous situations.
- The scooter balances from front to back but not side-to-side. Avoid riding across steep slopes.

1. Install free app called “Tao Tao Plus” from your smart phone by visiting App Store on apple device or Play store on any android device.
2. Once Tao Tao Plus app is installed, turn on Bluetooth under settings of your mobile device.
3. Power on Gyrocopters Hoverboard and launch the TAOTAO app. Click the bluetooth icon in the top left corner and look for device name “TaoTao” on your smart phone to connect. This will connect your mobile device with Gyrocopters Hoverboard and allow you to control and view various parameters of the Gyrocopters Hoverboard. If prompted for password, enter 000000.



While operating, the scooter can alert users if there are any irregularities in the system. If the scooter detects a fault in any of its redundant systems or the batteries are depleted beyond limit, it automatically slows down the motors. Flashing warning indicator light emits a warning tone, and disables self balancing mode.

Here are some reasons that will trigger the Warning Indicator Light:

- Irregular platform angle.
- Low Battery Voltage
- Plugged in and Charging
- Platform distortion while riding (System Shutdown)
- Speed Limit reached
- Platform angle is greater than 35 degrees (System Shutdown)
- Wheels get stuck
- Electrical Current Surge



- Risk of Fire, No User Serviceable Parts
- Do not get back on the scooter until the condition that caused the warning alert has been identified and corrected.
- Never restart and ride your scooter after it has indicated an empty Battery condition or shutdown due to low Battery. The Scooter may not have enough power to keep you balanced. If you restart and continue riding, you risk falling. Also you risk damaging your batteries, resulting in reduced battery life and capacity.



When riding the scooter you are at risk for serious injuries from loss of control, collisions, and falls. It is your responsibility to learn how to safely ride the scooter in order to reduce this risk. To ride safely you must follow all instructions in this user manual.

- Always wear proper attire when using the scooter, do not wear loose clothing that can catch in the tires and prevent proper steering.
- Never place anything on the foot mats except your feet.
- Avoid obstacles and surfaces that could result in a loss of balance or traction and cause a fall
- Use caution when riding over any terrain change such as pavement to sand, grass or speed bumps.
- Avoid riding across steep slopes, maintain both tires in contact with the ground.
- Avoid holes, curbs, and other obstacles.
- Avoid riding over any surface where the bottom of the scooter may impact any object.
- When using on a sidewalk, make sure the wheels do not drop off the curb
- Use caution when riding in new environments.
- Make sure you leave enough wheel clearance
- Be careful and considerate of others while riding.



- Always ride under control at a speed that is safe for you and those around you.
- Always be prepared to stop.
- Respect pedestrians by always yielding the right of way.
- Avoiding startling pedestrians. When approaching from behind, announce yourself and slow down to a walking speed when passing, and pass on the left whenever possible. When approaching a pedestrian from the front, stay to the right and slow down.
- In heavy pedestrian traffic conditions, slow down and proceed at the pace of pedestrian traffic. Pass only if there is ample space to do so safely. Do not weave in and out of pedestrian traffic.
- When riding with other scooter riders, maintain a safe distance. Identify hazards and obstacles, and do not ride side-by-side unless there is plenty of room left for pedestrians.
- Cross roads at designated crosswalks or signaled intersections. Do not jaywalk/ride.
- Only travel on a road when a pedestrian way is not available or when sidewalk use is not allowed. Do not ride your scooter on private property (inside or outside) unless you have obtained permission to do so.
- Learn about and obey applicable local laws and regulations.
- Inspect your scooter before ride it.
- Do not allow any person to use your scooter unless that person has carefully read this manual.



- Use caution on slopes, use caution when ascending , descending, or crossing slopes. When riding across any slope, lean uphill to maintain balance
- Always turn slowly and with caution, fast turns can lead to loss of control and falls.
- No passengers. The scooter is designed for one rider, do not ride in pairs or carry any passengers. Do not carry a child in your arms or in a child carrier while riding. Expectant mothers should not ride the scooter.
- Do not exceed the maximum weight limit (rider and all cargo) specified in this manual. If you exceed the maximum weight limit, you are at a greater risk of falling and injury. Also, the rider's weight must not be less than the minimum rider weight limit specified in this manual.
- Do not step off the scooter while moving, always come to a stop before stepping off.
- Be alert. As with any other transportation device, you must be mentally alert to safely ride. Do not attempt to ride if you are ill or if you cannot comply fully with the instructions and warnings in this manual. Do not ride under the influence of alcohol or drugs. Avoid distractions. Do not use a mobile phone, or engage in any other activity that might distract you or interfere with your ability to monitor your surroundings while riding.
- When riding , keep both feet on the foot mats. Be relaxed, ride in a relaxed position with your knees and elbows slightly bent and head up.



- Do not ride backwards for long periods of time. Instead, turn and ride forward.
- Riding on the road. The scooter is not intended or recommended for primary use on roads. If you must ride on the road, or must cross the road, be extremely careful. Ride as far away from traffic as possible. Check to make sure that riding on the road is allowed by local law.
- Use the Beginner Setting and ride in areas free of obstacles and distractions until you are comfortable using and maneuvering your scooter. Practice at the Beginner level until you can step on, ride forward and backward, turn, stop, and step off without any problems.



Lithium-ion Battery	2.0Ah, 36V 72WH
Motor	Dual Motor with Dual Independent Gyros
Run time on full charge	Up to 60 mins
Charging Temperature	0°C to 40°C / 32 °F to 104 °F
Charging time	2 to 3 hours
Input	DC 42V \mp 1A
Max Speed	12 km/h
Driving Mode	Three (3) Selective Speed Modes
Max Loading	75 KGs / 164 LBS
Mini Loading	15KGs / 33 LBS
Max Climbing Limit	10 degree
Temperature	-10°C to 50°C / 14°F to 122°F
Frame Material	Aluminum with Plastic Components
Wheel size	165mm / 6.5 inch
Product Dimensions	574*176*175 mm / 22.6*6.92 *6.88 inch
Net Weight	10kgs / 22LBS



- Do not use a battery if the battery pack casing is broken or if the battery emits an unusual odor, smoke, excessive heat or leaks any substance. Avoid contact with any substance seeping from the batteries.
- Keep out of reach of children and pets. Exposure to battery voltage could result in death or serious injury.
- Unplug or disconnect the scooter from AC power before removing or attaching batteries or performing any service. Never work on any part of the scooter when it is plugged into AC power source. You risk serious bodily injury from electric shock as well as damage to the scooter.
- The cells within the batteries contain toxic substances, do not attempt to open the batteries. Do not insert any object into the batteries or use any device to pry at the battery casing. If you insert an object into any of the battery ports or openings you could suffer electric shock, injury, burns, or cause a fire. Attempting to open the battery casing will damage the casing and could release toxic and harmful substances, and will render the pack unusable.
- Observe and follow all safety information on the warning label found on the batteries
- Failure to charge the batteries could result in permanent damage to them. Left unplugged, the batteries could fully discharge over time, causing permanent damage.
- Only use charging devices approved by scooter and never attempt to bypass or override their charging protection circuits.



- Do not attempt to wash the scooter with a power washer or high pressure hose. Avoid getting water into the charge port. Always close the charge port cover after charging is completed. Make sure that the charge port is dry before you plug in the power cord. Failure to follow these instructions could expose you to electric shock, injury, burns, or cause a fire.
- Do not submerge the batteries or platform in water, If you suspect the batteries or powerbase have been submerged or experienced water intrusion, do not attempt to remove the batteries. Do not plug the power cord into the scooter. Failure to follow these instructions could expose you to electric shock, injury, burns, or cause a fire.
- As with all rechargeable batteries, do not charge near flammable material.
- If you use, charge, or store the scooter batteries outside the limits specified, you may void the limited warranty, damage your batteries, and/or experience reduced range and ineffective battery charging.

Note: Lithium-ion batteries are regulated as “Hazardous Materials”. Transporting Lithium battery by air, or other methods, might be prohibited by policies or law . Please contact the designated agents from the carrier company for more details.

Warranty Details

Gyrocopters offer 90 days warranty on all products. 90 days warranty commences from the date of purchase. Please retain your payment receipt/order#, and original packaging for proof of purchase and to claim your warranty/repairs. All defective merchandise are eligible for repair within 90 days of the original purchase date.

This warranty DOES NOT cover normal wear and tear or any other physical damage or liquid damage caused to your parts/unit by improper usage or handling. Warranty does not cover over-charging, or damages due to improperly maintaining the lithium battery installed in the unit. Opening and altering the device will void any original manufacturing warranty. By opening your unit, you acknowledge that you assume all responsibility for your device, and its functionality or lack thereof. We assume no liability for loss or damages caused by unsafe riding and/or improper usage. Our warranty does not cover when used unsafely or out of limits.

Gyrocopters will only accept returns or unused and undamaged products that are returned in the original packaging within 14 days of your purchase date.

IMPORTANT: This warranty does not cover physical damages resulting from accident, misuse, or abuse, lack of reasonable care, the affixing of any attachments, stunts, tricks, loss of parts, over-load or subject in the product to any but the specified voltage. Use of unauthorized replacement parts will void warranty. This warranty is only eligible for the purchase of the initial Gyrocopters Pro 6.0 Hoverboard. No responsibility is assumed for any special incidental or consequential damages.

Contact Details:

Gyrocopters e-mobility systems
www.gyrocopters.ca
For support: customercare@imgadgets.ca

Warning:
LED Wheels are fragile so please do NOT drop them vertically!



DO NOT drop
the hoverboard vertically