



# User Manual

Gyrocopters off road - 8finiti





Before You Begin-----01



Main Components-----02



Charging Your Batteries-----03



Powering on the Scooter-----04



Indicator Lights -----05



Pairing your Bluetooth Device ----06



Riding Your Scooter-----07-10



Mobile App -----11



Safety Alerts-----12



Driving Safety-----13-16



Technical Specifications-----17



Battery Safety-----18-19



## Before You Begin

Before learning to ride your scooter, you must read and follow all instructions and warnings in this user manual. It is important that you follow all safety warnings and cautions that appear throughout the user manual and that you use good judgment when you ride your scooter.

## The Risk of injury

The scooter is a self-balancing, personal scooter that uses balancing technology. Balancing technology cannot prevent injury if you do not ride the scooter safely. Whenever you ride the scooter, you risk death or serious injury from loss of control, collisions, and falls.

To reduce the risk of injury, you must read and follow all instructions and warnings in the user manual.

## Disposal and Storage

Disposal according to local laws.

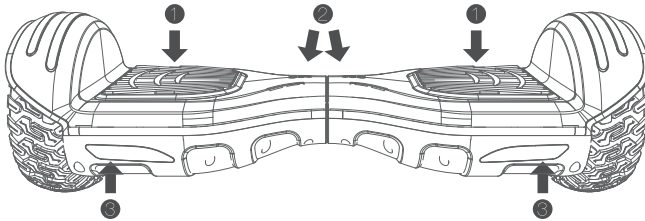

- ① Foot Mat
- ② Indicator Lights
- ③ Headlights

Charging Port ④  
Power Button ⑤

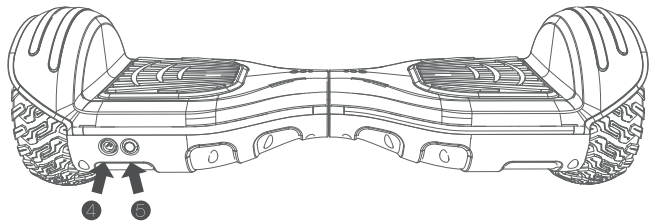

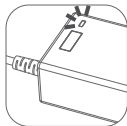
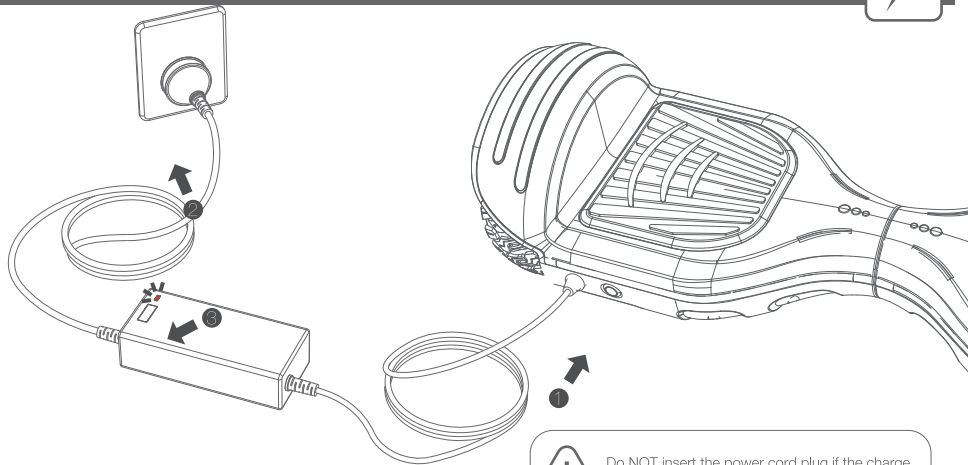

## Battery Charge Indicator Light

- " **Red** " When scooter is plugged in and charging, battery charge indicator will be solid red.
- " **Green** " If battery charge indicator is green, the batteries are fully charged.



Do NOT insert the power cord plug if the charge port, power cord or AC power outlet is wet.

Model CP2915 manufactured by COMING DATA CO LTD  
Input:100-130Vac,50/60Hz,1A Output:29.4Vdc,1A



## Powering On the Scooter

Power on your scooter by pressing the Power button. The Power button is located on the back side of the scooter. The indicator lights will illuminate to indicate the power is ON.

## Resetting the Scooter

- 1 Put the scooter on a level surface where the wheels do not make contact with the ground.
- 2 Press the Power button for 3-5 seconds until caution light flashes.
- 3 Turn OFF the scooter and turn ON again.

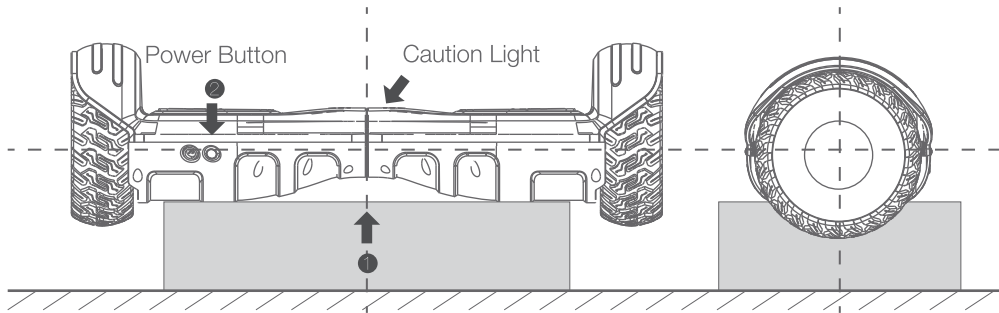



## ① Warning Indicator Light (Red)

If red warning light is flashing, there is an issue with the scooter (low battery, over speed, power issue, etc.)

## ② Balance Indicator Light (Green)

The scooter is in Balance Mode with ride on.

## ③ Battery Status Indicator Light (Green)

When power is ON, battery status indicator light 1 will be solid green. If it is OFF, power shuts off.

## ④ When light 2 turns red, please power off then turn on again

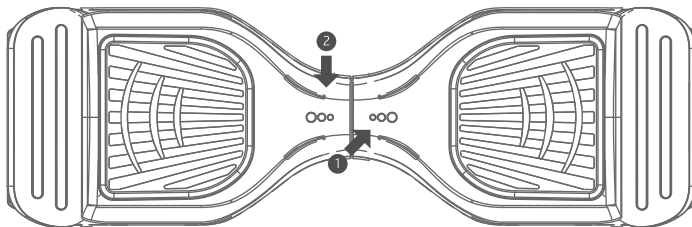





To pair with a Bluetooth® device follow these steps:

- 1 Make sure both the Bluetooth® function in your device and the scooter are turned on.
- 2 Open the bluetooth settings on your device to connect wirelessly to the scooter.
- 3 On your device, locate the Bluetooth® device list. Select “Gyrocopters 8finiti” from the list .

### Resetting Bluetooth® Memory

To reset Bluetooth® Memory, resetting the scooter is needed. Refer to **Resetting the scooter** (page 4).

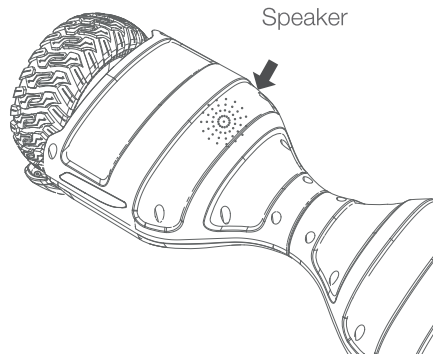



Before riding, make sure your scooter is fully assembled and charged. Inspect your scooter before each use. Do not ride if any part is loose or damaged.

The scooter is highly maneuverable and allows you to easily navigate around obstacles. However, to prevent the loss of traction, you must always be careful when riding and learn to identify and avoid unsafe surfaces. Slippery, icy or wet surfaces, loose materials (sand/gravel), steep slopes, and obstacles might affect the scooter performance.

Familiarize yourself with the indicator lights that may be displayed on the scooter.

**Step 1. Power ON the scooter by pressing the Power button. Make sure the Battery Status Indicator light is ON.**

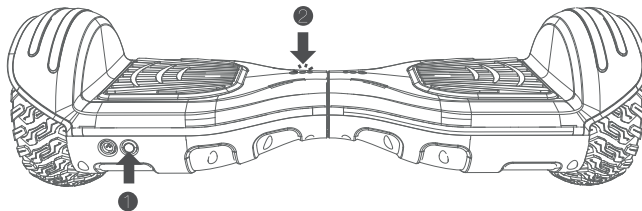



**NOTE:** The scooter comes with the No-Fall Technology mode turned on. This feature keeps the board upright whether you are standing on it or not.

## Step 2: Getting on the Scooter

- 1 Place one foot on the foot mat.
- 2 The Balance indicator light will turn ON, enabling the automatic balancing system.
- 3 Try to keep scooter steady and leveled.
- 4 Place your other foot on the other foot mat.

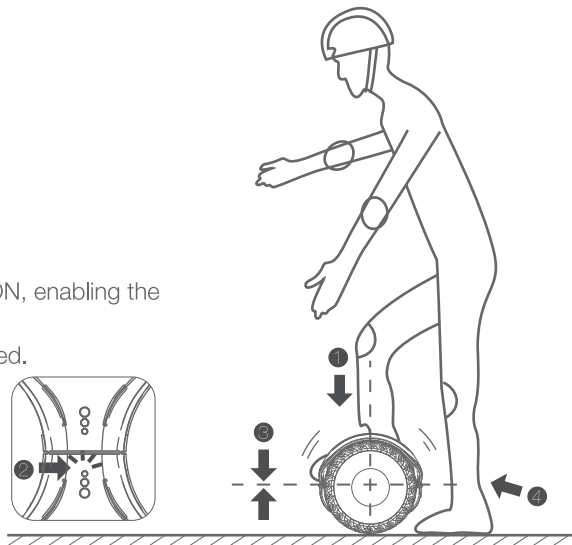



## Step 3: Moving forward and backward

- 1 Keep scooter still by remaining level when standing on it.
- 2 SLIGHTLY lean your body forward or backward to enable the scooter to move forward or backwards respectively.

NOTE, When the scooter is unable to achieve a balanced position, an alarm will sound and trigger the Warning Indicator light. The scooter will return to a balanced position automatically. During this process, you should not step on or ride the scooter.



- Body leaning should be done in small increments. Only small leaning angles are needed to drive the scooter forward or backward.
- Leaning forward or backward too much can affect riding safety.

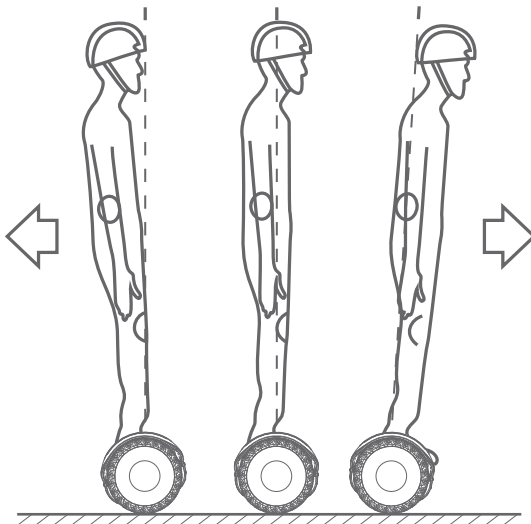

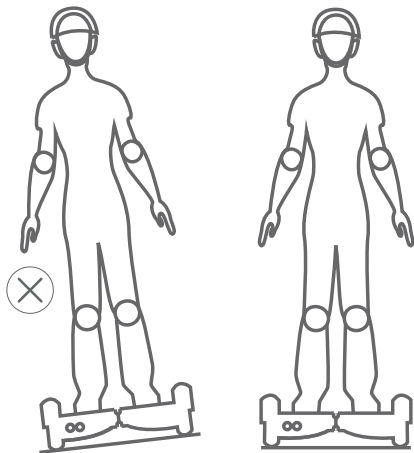

- Do not turn while in high speeds to avoid dangerous situations.
- The scooter balance front-to-back but not side-to-side. Avoid riding across steep slopes.

## Step 4: Steering the Scooter

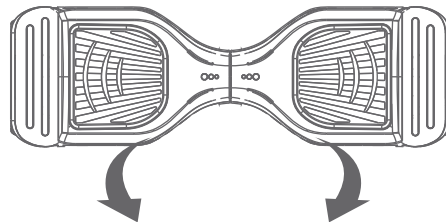

Press right foot forward  
to turn left

Press left foot forward  
to turn right

## Step 5: Getting Off the Scooter

Make sure the scooter is completely stopped and stable before stepping off. Step off the scooter one foot at a time.

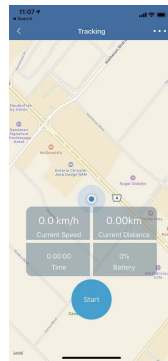
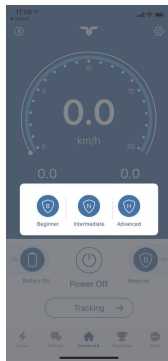

1. Install free app called “Tao Tao Plus” from your smart phone by visiting App Store on apple device or Play store on any android device.
2. Once Tao Tao Plus app is installed, turn on Bluetooth under settings of your mobile device.
3. Power on Gyrocopters Hoverboard and launch the TAOTAO app. Click the bluetooth icon in the top left corner and look for deevice name “TaoTao” on your smart phone to connect. This will connect your mobile device with Gyrocopters Hoverboard and allow you to control and view various parameters of the Gyrocopters Hoverboard. If prompted for password, enter 000000.



While operating, the scooter can alert users if there are any irregularities in the system. If the scooter detects a fault in any of its redundant systems or the batteries are depleted beyond limit, it automatically slows down the motors. Flashing warning indicator light emits a warning tone, and disables self-balancing mode.

### Here are some reasons that will trigger the Warning Indicator Light:

- Irregular platform angle
- Low battery voltage
- Plugged in and charging
- Platform distortion while riding (System Shutdown)
- Speed limit reached
- Platform angle is greater than 35 degrees (System Shutdown)
- Wheels get stuck
- Electrical current surge



- Risk of Fire; No User Serviceable Parts.
- Do not get back on the scooter after until the condition that caused the warning alert has been identified and corrected.
- Never restart and ride your scooter after it has indicated an empty battery condition or shutdown due to low battery. The scooter may not have enough power to keep you balanced. If you restart and continue riding, you risk falling. Also you risk damaging your batteries, resulting in reduced battery life and capacity.



When riding the scooter you risk serious injury from loss of control, collisions and falls. It is your responsibility to learn how to safely ride the scooter in order to reduce this risk. To ride safely you must follow all instructions in the user material.

- Always wear proper attire when using the scooter, do not wear loose clothing that can get caught in the tires and prevent proper steering.
- Never place anything on the foot mats except your feet.
- Avoid obstacles and surfaces that could result in a loss of balance or traction and cause a fall.
- Use caution when riding over any terrain change such as pavement to sand, grass or speed bumps.
- Avoid riding across steep slopes. Maintain both tires in contact with the ground.
- Avoid holes, curbs and other obstacles.
- Avoid riding over any surface where the bottom of the scooter may impact any object.
- When using on sidewalk, make sure that the wheel does not drop off the curb.
- Use caution when riding in new environments.
- Make sure you leave enough wheel clearance.
- Be careful and considerate of others while riding.





- Always ride under control at a speed that is safe for you and those around you.
- Always be prepared to stop.
- Respect pedestrians by always yielding the right of way.
- Avoid startling pedestrians. When approaching from behind, announce yourself and slow down to walking speed when passing. Pass on the left whenever possible. When approaching a pedestrian from the front, stay to the right and slow down.
- In heavy pedestrian traffic conditions, slow down and proceed at the pace of pedestrian traffic. Pass only if there is ample space to do so safely. Do not weave in and out of pedestrian traffic.
- When riding with other scooter riders, maintain a safe distance, identify hazards and obstacles, and do not ride side-by-side unless there is plenty of room left for pedestrians.
- Cross roads at designated crosswalks or signaled intersections. Do not jaywalk/ride.
- Only ride on a road when a pedestrian way is not available or when sidewalk use is not allowed. Do not ride your scooter on private property (inside or outside) unless you have obtained permission to do so.
- Learn and obey applicable local laws and regulations.
- Inspect your scooter before riding it.
- Do not allow any person to use your scooter unless that person has carefully read this manual.



- Use caution on slopes. Use caution when ascending, descending or crossing slopes. When riding across any slope, lean uphill to maintain balance.
- Always turn slowly and with caution. Fast turns can lead to loss of control and falls.
- No passengers. The scooter is designed for one rider. Do not ride double or carry any passengers. Do not carry a child in your arms or in a child carrier while riding. Expectant mothers should not ride the scooter.
- Do not exceed the maximum weight limit (rider and all cargo) specified in this manual. If you exceed the maximum weight limit, you are at greater risk of falling and injuries. Also, the rider's weight must not be less than the minimum rider weight limit specified in this manual.
- Do not step off the scooter while it is moving. Always come to a stop before stepping off.
- Be alert. As with any other transportation device, you must be mentally alert to safely ride.
- Do not attempt to ride if you are ill or if you cannot comply fully with the instructions and warnings in this manual. Do not ride under the influence of alcohol or drugs. Avoid distractions.
- Do not use a mobile phone, or engage in any other activity that might distract you or interfere with your ability to monitor your surroundings while riding.
- When riding, keep both feet on the foot mats. Be relaxed. Ride in a relaxed position with your knees and elbows slightly bent and head up.



- Do not ride backward for long periods of time. Instead, turn and ride forward.
- Riding on the road: The scooter is not intended or recommended for primary use on roads. If you must ride on the road, or must cross the road, be extremely careful. Ride as far away from traffic as possible. Check to make sure that riding on the road is allowed by local law.
- Use the Beginner setting and ride in areas free of obstacles and distractions until you are comfortable using and maneuvering your scooter. Practice at the Beginner level until you can step on, ride forward and backward, turn, stop and step off without any problems.



<b>Lithium-ion Battery</b>	4.0Ah, 25.9V 103.6WH
<b>Motor</b>	Dual Motor with Dual Independent Gyros
<b>Distance on Full Charge</b>	12 km / 7.5 miles
<b>Charging Temperature</b>	0C to 40C / 32 °F to 104 °F
<b>Charging Time</b>	2 to 3 hours
<b>Input</b>	DC 29.4V $\approx$ 1.5A
<b>Max Speed</b>	10 km/h / 6mPH
<b>Water Resistance</b>	IPX4
<b>Max Loading</b>	120 kgs / 264 LBS
<b>Max Climbing Limit</b>	15 degree
<b>Temperature</b>	-10C to 45C / 14°F to 113°F
<b>Frame Material</b>	Aluminum with Plastic Components
<b>Wheel Size</b>	165 mm / 6.5 inch
<b>Product Dimensions</b>	605*190*186 mm / 23.8*7.48 *7.32 inch
<b>Net Weight</b>	9 kgs / 19.8 LBS



- Do not use a battery if the battery pack casing is broken or if the battery emits an unusual odor, smoke, excessive heat or leaks any substance. Avoid contact with any substance seeping from the batteries.
- Keep out of reach of children and pets. Exposure to battery voltage could result in death or serious injury.
- Unplug or disconnect the scooter from AC power before removing or attaching batteries or performing any service. Never work on any part of the scooter when it is plugged into AC power source. You risk serious bodily injury from electric shock as well as damage to the scooter.
- The cells within the batteries contain toxic substances. Do not attempt to open the batteries. Do not insert any object into the batteries or use any device to pry at the battery casing. If you insert an object into any of the battery ports or openings you could suffer electric shock, injury, burns, or cause a fire. Attempting to open the battery casing will damage the casing and could release toxic and harmful substances, and will render the pack unusable.
- Observe and follow all safety information on the warning label found on the batteries.
- Failure to charge the batteries could result in permanent damage to them. Left unplugged, the batteries could fully discharge over time, causing permanent damage.
- Using only charging devices approved for the scooter and never attempt to bypass or override their charging protection circuits.



- Do not attempt to wash the scooter with a power washer or high-pressure hose. Avoid getting water into the charge port. Always close the charge port cover after charging is completed. Make sure that the charge port is dry before you plug in the power cord. Failure to follow these instructions could expose you to electric shock, injury, burns, or cause a fire.
- Do not submerge the batteries or platform in water. If you suspect the batteries or powerbase have been submerged or experienced water intrusion, do not attempt to remove the batteries. Do not plug the power cord into the scooter. Failure to follow these instructions could expose you to electric shock, injury, burns, or cause a fire.
- As with all rechargeable batteries, do not charge near flammable material.
- If you use, charge or store the scooter batteries outside the limits specified, you may void the limited warranty, damage your batteries and/or experience reduced range and ineffective battery charging.

Note: Lithium-ion batteries are regulated as “Hazardous Materials”. Transporting a Lithium battery by air, or other methods, might be prohibited by policies or law. Please contact the designated agents from the carrier company for more details.



