



bathonomy

ASME A112.18.1 / CSA B125.1
NSF61, NSF372



Metro 3-Way Tub Spout, Hand Shower And Head Included Complete Shower Set - Wall Mount - 8" Brass/Matt Black

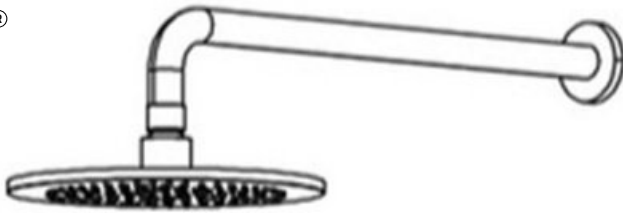

- Working pressure:
- Min: 20 PSI (1.5 bar)
 - Max: 125 PSI (8 bar)
 - Recommended: 45 PSI (3 bar)
 - Hot water inlet max. temperature: 180 °F (80 °C)
 - Water inlet threads: 1/2 NPT female
 - Full brass

- Tub spout features:
- NPT 1/2 in. male inlet.
 - Full brass construction.
 - Adjustable scutcheon

- Shower head features:
- Thin design (0.2 in. / 5 mm)
 - G 1/2 in. female inlet
 - Full rain spray single function
 - 1.8 Gpm @ 80 PSI
 - Silicone sharp nozzles easy to clean
 - Made in stainless steel.

- Shower arm features:
- Wall mount.
 - NPT 1/2 in. inlet . G 1/2 in. outlet
 - 15" length
 - Movil scutcheon
 - Full brass construction.

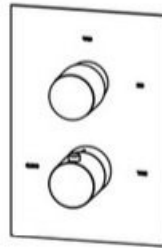

- Connector features:
- Round design with holder for hand shower.
 - NPT 1/2 in. inlet. G 1/2 in. outlet

- Hose features:
- Length 60 in.
 - Stainless Steel construction.
 - NPT 1/2 in. inlet

- Hand shower features:
- Round design.
 - Only rain function.
 - 1.8 Gpm
 - G1/2 in. Inlet.
 - Silicone nozzles easy to clean.
 - Brass construction.
 - Material: Brass
 - Finish/Color: Matt Black

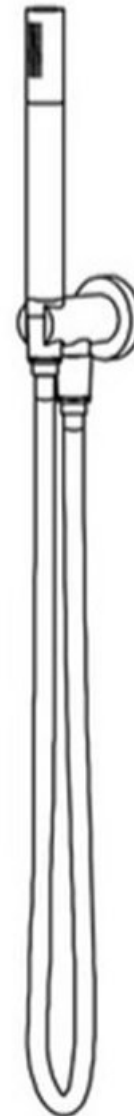

- Dimensions:
- Weight: 15.6 lb.

COMPONENTS:

- Shower arm wall mount 15 in. length.
- Shower head 8 in. with sharp nozzles.
- Shower mixer rough-in valve with trim.
- Hand shower holder connector.
- Hose.
- Hand shower round design.
- Tub spout square.

COLOR	CODE	DESCRIPTION
	MBL	MATT BLACK



bathonomy Shower Arm

Metro

Shower Arm - 14"

Features

Modern shower arm of our Metro family, a family of components for your shower with a round and modern design that will delight your daily shower. This family covers everything you need to build your bathroom area: mixers, heads, hand showers, connectors, tub spout, etc. Available in different finishes and functions.

- Shower arm.
- NPT 1/2 in. inlet
- G 1/2 in. outlet

Material

- Premium material construction with metal handle ensures reliability and durability.
- BATHONOMY finishes resist corrosion and tarnishing.
- Brass construction

Dimensions

- H: 3.5" * D: 14" / Ø: 0.93"

Weight

- 1.1 lb.



Codes/Standards



COF.SHA.MTO.14.00.BR.MBL

BATHONOMY Faucet Lifetime Limited Warranty

See website for detailed warranty information.

Available Colors/Finishes

Color tiles intended for reference only.

Color	Code	Description
	BNI	Brushed Nickel
	MBL	Matt Black
	PCH	Polished Chrome
	SBR	Satin Brass



Codes / Standards compliance: Uniform Plumbing Code (UPC)
 National Plumbing Code of Canada
 ASME A112.18.1-2018 / CSA B125.1-18 / ASSE 1016
 IAPMO file number: 8659 (for more info visit: <http://pld.iapmo.org/default.aspx>)
 SKU for iapmo search LTA1010



bathonomy ShowerArm

Metro

Shower Arm - 14"

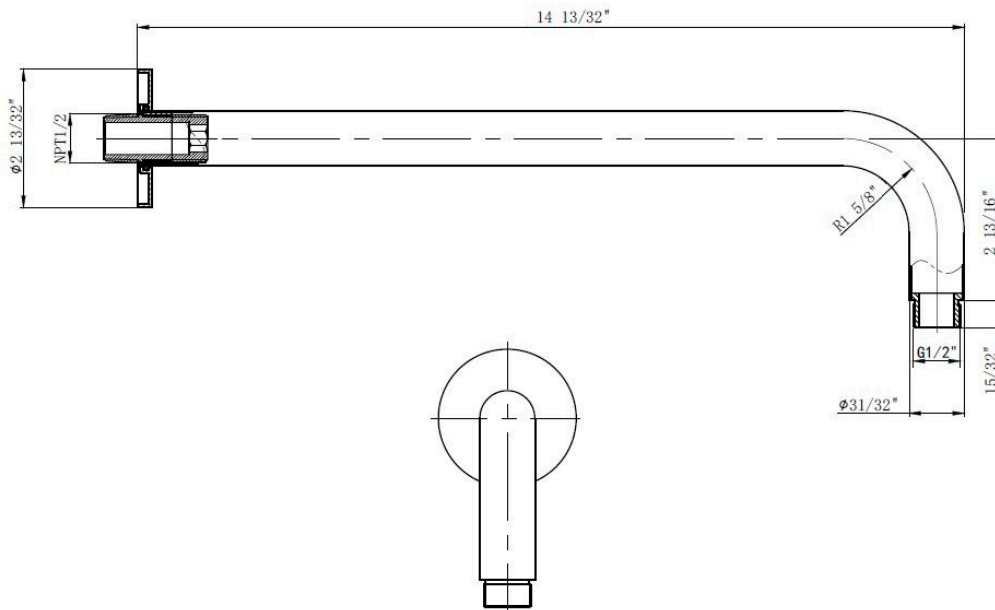

Technical Information

All product dimensions are nominal.

Notes

Install the product according to the installation guide.



bathonomy ShowerHead

Metro

Sharp Nozzles Shower Head Wall
Or Ceiling Mount - 8"

Features

Modern shower head of our Metro family, a family of components for your shower with a round and modern design that will delight your daily shower. This family covers everything you need to build your bathroom area: mixers, heads, hand showers, connectors, tub spout, etc. Available in different finishes and sizes.

- Shower head
- Thin design (5mm / 0.2 in.)
- G 1/2 in. inlet
- Silicone sharp nozzles easy to clean
- 1.8 Gpm
- Rustproof: Yes

Material

- Premium material construction with metal handle ensures reliability and durability.
- BATHONOMY finishes resist corrosion and tarnishing.
- Stainless steel construction

Dimensions

- H: 0.2" * / Ø: 8"

Weight

- 2.2 lb.

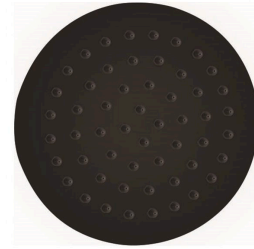

Codes/Standards

COF.SHH.MTO.08.00.SS.MBL

BATHONOMY Faucet Lifetime Limited Warranty
See website for detailed warranty information.

Available Colors/Finishes

Color tiles intended for reference only.

Color Code Description

Color	Code	Description
	BSS	Brushed Stainless Steel
	MBL	Matt Black
	PSS	Polished Stainless Steel
	SBR	Satin Brass



Codes / Standards compliance: Uniform Plumbing Code (UPC)
National Plumbing Code of Canada
ASME A112.18.1-2018 / CSA B125.1-18 / ASSE 1016
IAPMO file number: 8659 (for more info visit: <http://pld.iapmo.org/default.aspx>)
SKU for iapmo search LTA1010



bathonomy ShowerHead

Metro

Sharp Nozzles Shower Hea Wall
Or Ceiling Mount - 8"

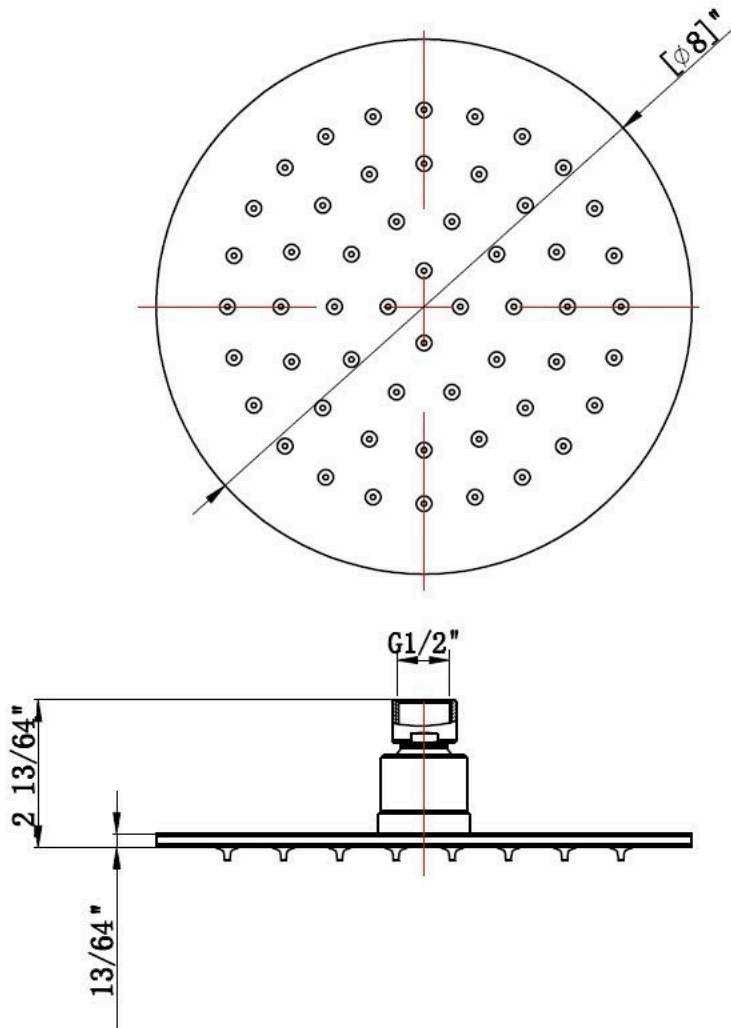

Technical Information

All product dimensions are nominal.

Notes

Install the product according to the installation guide.



bathonomy Shower Mixer

Metro

Thermostatic 2-3 Way Shower Mixer - Wall Mount - 4"

Features

- Thermostatic valve.
- Brass valve body.
- Zinc alloy handles.
- Stainless steel trim plate with chrome surface.
- Designed to fit into standard 4.5" frame wall.
- Delivers a generous flow rate.
- Standard 1/2 inch inlet and outlet.
- Flow rate 3.4 GPM.
- Diverter with 2 or 3 functions configurable during the installation process.
- Sedal ceramic thermostatic cartridge.
- Integrated shut-off valves.

Material

- Premium material construction with metal handle ensures reliability and durability.
- BATHONOMY finishes resist corrosion and tarnishing.
- Brass

Dimensions

- W: 4.3" * H:7.9" * D: 4"

Weight

- 8.8 lb.



Codes/Standards



COF.SHM.MTO.04.00.BR.MBL

BATHONOMY Faucet Lifetime Limited Warranty

See website for detailed warranty information.

Available Colors/Finishes

Color tiles intended for reference only.

Color	Code	Description
	BNI	Brushed Nickel
	MBL	Matt Black
	PCH	Polished Chrome
	SBR	Satin Brass



Codes / Standards compliance: Uniform Plumbing Code (UPC)
 National Plumbing Code of Canada
 ASME A112.18.1-2018 / CSA B125.1-18 / ASSE 1016
 IAPMO file number: 8659 (for more info visit: <http://pld.iapmo.org/default.aspx>)
 SKU for iapmo search LTA1010



bathonomy ShowerMixer

Metro

Thermostatic 2-3 Way Shower Mixer - Wall Mount - 4"

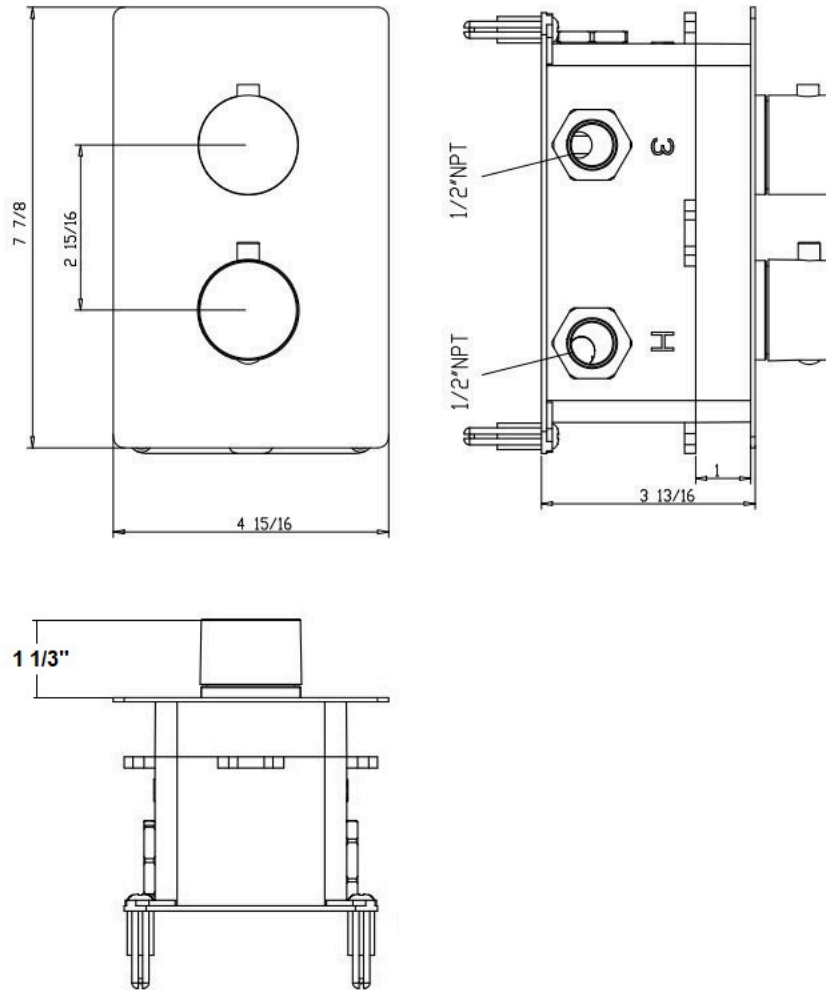

Technical Information

All product dimensions are nominal.

Shower head included: No

Shower arm: No

Notes

Install the product according to the installation guide.



bathonomyHandShowerConnetor

Metro

Hand Shower Holder
Connetor Wall Mount - 3"

Features

Modern hand shower hose holder with connector of our Metro family, a family of components for your shower with a round and modern design that will delight your daily shower. This family covers everything you need to build your bathroom area: mixers, heads, hand showers, connectors, tub spout, etc. Available in different finishes and functions.

- Hose connector with holder
- Adjustable scutcheon
- NPT 1/2 in. inlet
- G 1/2 in. outlet



Material

- Premium material construction with metal handle ensures reliability and durability.
- BATHONOMY finishes resist corrosion and tarnishing.
- Brass construction

Dimensions

- W: 2.87" * H: 2.37" * D: 3.12" / Ø: 1.25"

Weight

- 1.0 lb.

Codes/Standards



COF.HHC.MTO.03.00.BR.MBL

BATHONOMY Faucet Lifetime Limited Warranty

See website for detailed warranty information.

Available Colors/Finishes

Color tiles intended for reference only.

Color	Code	Description
	BNI	Brushed Nickel
	MBL	Matt Black
	PCH	Polished Chrome
	SBR	Satin Brass



Codes / Standards compliance: Uniform Plumbing Code (UPC)
National Plumbing Code of Canada
ASME A112.18.1-2018 / CSA B125.1-18 / ASSE 1016
IAPMO file number: 8659 (for more info visit: <http://pld.iapmo.org/default.aspx>)
SKU for iapmo search LTA1010



bathonomyHandShowerConnector

Metro

Hand Shower Holder
Connector Wall Mount - 3"

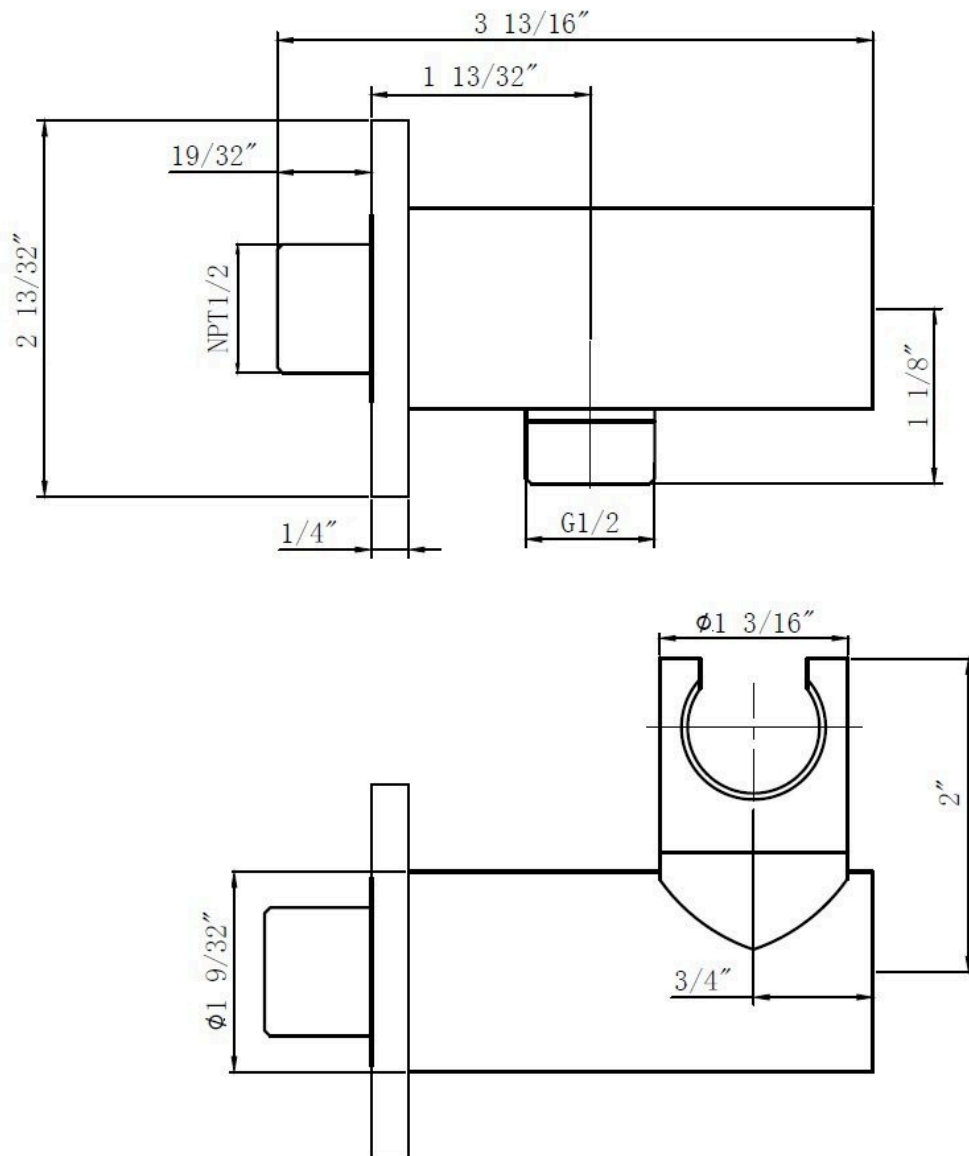

Technical Information

All product dimensions are nominal.

Notes

Install the product according to the installation guide.



bathonomy ShowerHose

ShowerComplements

Hand Shower Hose
Wall Mount - 5"

Features

Traditional and modern hand shower hose of our Shower Complements family, a family of components where you will find what you need to complete the installation of your shower. Available in different finishes.

- Hand shower hose
- 60 in. length
- Round connector on each end.
- Rubber washer on the bracket connector to prevent slipping.
- NPT 1/2 in. inlet and outlet connections.

Material

- Premium material construction with metal handle ensures reliability and durability.
- BATHONOMY finishes resist corrosion and tarnishing.
- Stainless steel construction

Dimensions

- W: 120" * / Ø: 0.5"

Weight

- 0.3 lb.



Codes/Standards

COF.HHO.SCO.05.00.SS.MBL

BATHONOMY Faucet Lifetime Limited Warranty

See website for detailed warranty information.

Available Colors/Finishes

Color tiles intended for reference only.

Color	Code	Description
	BNI	Brushed Nickel
	MBL	Matt Black
	PCH	Polished Chrome
	SBR	Satin Br



Codes / Standards compliance: Uniform Plumbing Code (UPC)
 National Plumbing Code of Canada
 ASME A112.18.1-2018 / CSA B125.1-18 / ASSE 1016
 IAPMO file number: 8659 (for more info visit: <http://pld.iapmo.org/default.aspx>)
 SKU for iapmo search LTA1010



bathonomyHandShower

Metro

Hand Shower
Wall Mount - 1"

Features

Modern hand shower of our Metro family, a family of components for your shower with a round and modern design that will delight your daily shower. This family covers everything you need to build your bathroom area: mixers, heads, tubes, connectors, tub spout, etc. Available in different finishes and function.

- Hand shower
- Only rain function
- 1.8 Gpm.
- G 1/2" inlet

Material

- Premium material construction with metal handle ensures reliability and durability.
- BATHONOMY finishes resist corrosion and tarnishing.
- Brass construction
- Silicone sharp nozzle easy to clean.

Dimensions

- H: 9" * / Ø: 0.93"

Weight

- 0.6 lb.



Codes/Standards

COF.HSH.MTO.01.00.BR.MBL

BATHONOMY Faucet Lifetime Limited Warranty

See website for detailed warranty information.

Available Colors/Finishes

Color tiles intended for reference only.

Color	Code	Description
	BNI	Brushed Nickel
	MBL	Matt Black
	PCH	Polished Chrome
	SBR	Satin Brass



Codes / Standards compliance: Uniform Plumbing Code (UPC)
 National Plumbing Code of Canada
 ASME A112.18.1-2018 / CSA B125.1-18 / ASSE 1016
 IAPMO file number: 8659 (for more info visit: <http://pld.iapmo.org/default.aspx>)
 SKU for iapmo search LTA1010



bathonomy HandShower

Metro

Hand Shower
Wall Mount - 1"

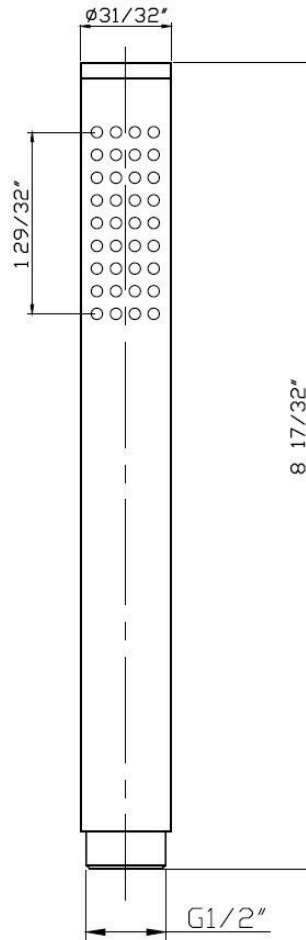

Technical Information

All product dimensions are nominal.

Notes

Install the product according to the installation guide.



bathonomy TubSpout

Metro

Tub Spout - Wall Mount - 7"

Features

Modern bathtub spout of our Metro family, a family of components for your shower with a round and modern design that will delight your daily shower. This family covers everything you need to build your bathroom area: mixers, heads, hand showers, connectors, tub spout, etc. Available in different finishes and functions.

- Bathtub spout
- NPT 1/2 in. inlet
- Adjustable scutcheon
- Rustproof: Yes

Material

- Premium material construction with metal handle ensures reliability and durability.
- BATHONOMY finishes resist corrosion and tarnishing.
- Brass construction

Dimensions

- W: 2.12" * H: 2.12" * D: 7.5" / Ø: 1.37"

Weight

- 1.5 lb.



Codes/Standards

COF.TUS.MTO.07.05.BR.MBL





BATHONOMY Faucet Lifetime Limited Warranty

See website for detailed warranty information.

Available Colors/Finishes

Color tiles intended for reference only.

Color Code Description

	BNI	Brushed Nickel
	MBL	Matt Black
	PCH	Polished Chrome
	SBR	Satin Brass



Codes / Standards compliance: Uniform Plumbing Code (UPC)
 National Plumbing Code of Canada
 ASME A112.18.1-2018 / CSA B125.1-18 / ASSE 1016
 IAPMO file number: 8659 (for more info visit: <http://pld.iapmo.org/default.aspx>)
 SKU for iapmo search LTA1010

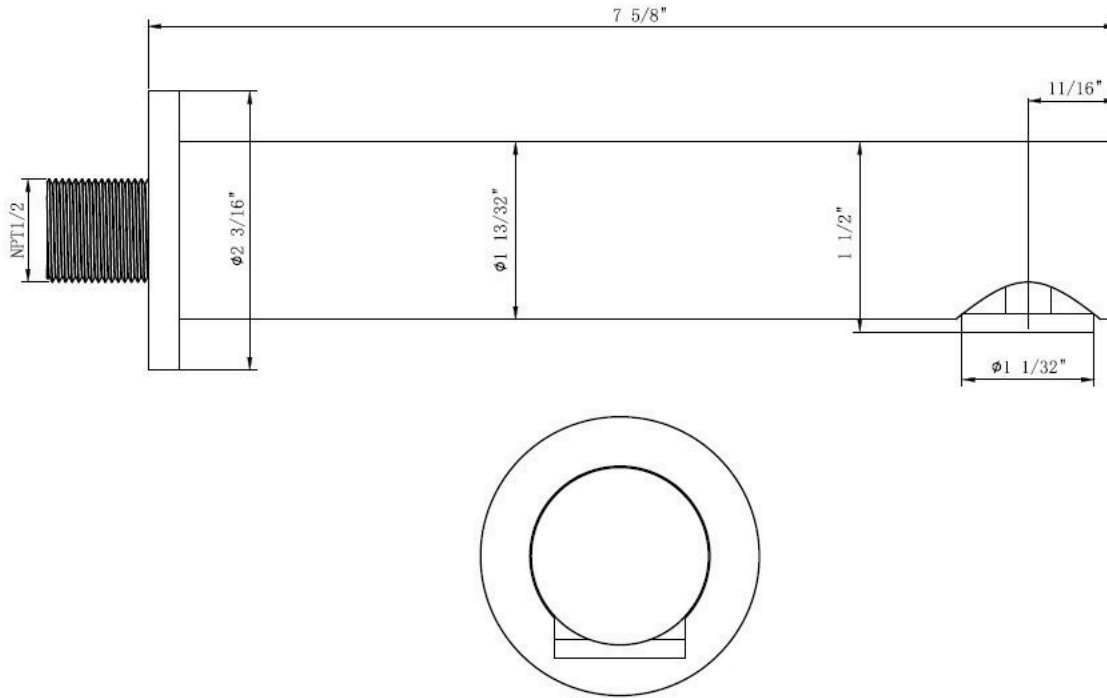

Technical Information

All product dimensions are nominal.

Notes

Install the product according to the installation guide.