



bathonomy

ASME A112.18.1 / CSA B125.1
NSF61, NSF372



Metro 2-Way Hand Shower And Head Included Complete Shower Set - Wall Mount - 8" Brass/Polished Chrome

COMPONENTS:

- Shower arm wall mount 14 in. length.
- Shower head 8 in. slim design with sharp nozzles.
- Connector with swivel holder.
- Hose 5 feet.
- Hand shower round with sharp silicone nozzles.
- Shower mixer rough-in valve with trim.

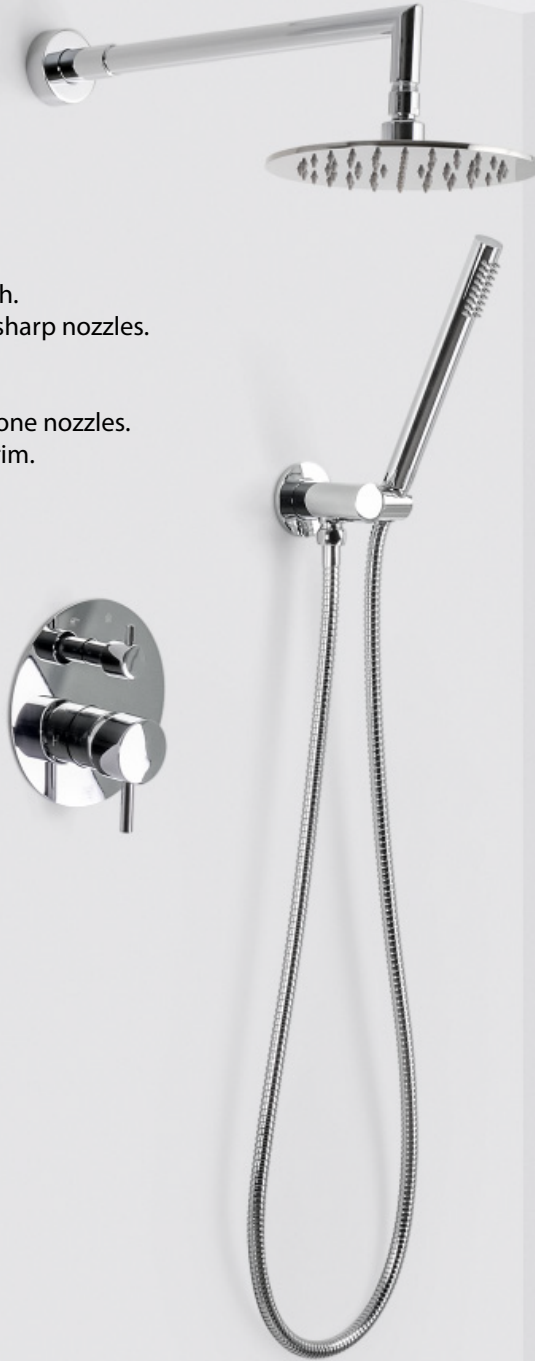

Working pressure:

- Min: 20 PSI (1.5 bar)
- Max: 125 PSI (8 bar)
- Recommended: 45 PSI (3 bar)
- Hot water inlet max. temperature: 180 °F (80 °C)
- Water inlet threads: 1/2 NPT male
- Full brass

Connector features:

- Round design with swivel holder for hand shower.
- NPT 1/2 in. inlet. G 1/2 in. outlet

Hose features:

- Length 60 in.
- Stainless Steel construction.
- NPT 1/2 in. inlet

Hand shower features:

- Round design.
- Only rain function.
- 1.8 Gpm
- G1/2 in. Inlet.
- Silicone square nozzles easy to clean.
- Brass construction.

Shower head features:

- Thin design (0.2 in. / 5 mm)
- G 1/2 in. female inlet
- Full rain spray single function
- 1.8 Gpm @ 80 PSI
- Silicone sharp nozzles easy to clean
- Made in stainless steel.

Shower arm features:

- Wall mount.
- NPT 1/2 in. inlet . G 1/2 in. outlet
- 14" length
- Mobil scutcheon
- Full brass construction.
- Material: Brass
- Finish/Color: Brushed Nickel

Dimensions:

- Weight: 9.3 lb.

COLOR	CODE	DESCRIPTION
	PCH	POLISHED CHROME



bathonomy Shower Arm

Smart

Shower Arm - Wall Mount - 15"

Features

Elegant and traditional shower arm. Of our family of accessories Smart. This shower arm is manufactured in full brass. Wall mounted.

- Shower arm
- Suggested room fit: Showers
- 1/2" NPT male inlet and outlet

Material

- Premium material construction with metal handle ensures reliability and durability.
- BATHONOMY finishes resist corrosion and tarnishing.
- Stainless steel construction

Dimensions

- W: 15" * Ø: 0.87"

Weight

- 0.6 lb.



Codes/Standards

JUM.SHA.SMA.15.00.BR.PCH

BATHONOMY Faucet Lifetime Limited Warranty

See website for detailed warranty information.

Available Colors/Finishes

Color tiles intended for reference only.

Color Code Description

Color	Code	Description
	BSS	Brushed Stainless Steel
	MBL	Matt Black
	PSS	Polished Stainless Steel
	SBR	Satin Brass



Codes / Standards compliance: Uniform Plumbing Code (UPC)

National Plumbing Code of Canada

ASME A112.18.1-2018 / CSA B125.1-18 / ASSE 1016

IAPMO file number: 8659 (for more info visit: <http://pld.iapmo.org/default.aspx>)

SKU for iapmo search LTA1010

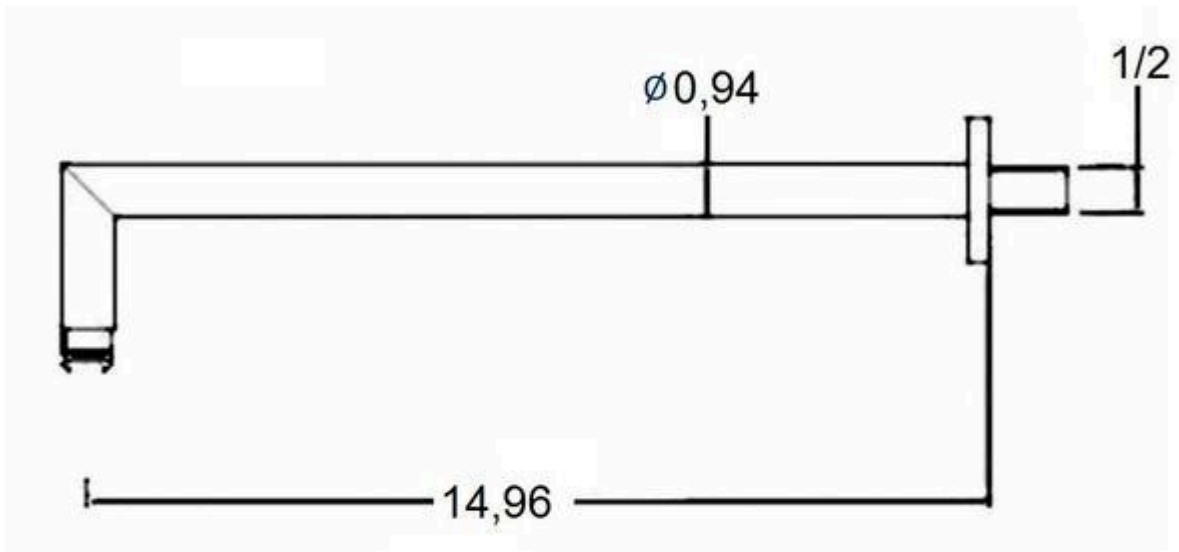

Technical Information

All product dimensions are nominal.

Notes

Install the product according to the installation guide.



bathonomy ShowerHead

Metro

Sharp Nozzles Shower Head Wall
Or Ceiling Mount - 8"

Features

Modern shower head of our Metro family, a family of components for your shower with a round and modern design that will delight your daily shower. This family covers everything you need to build your bathroom area: mixers, heads, hand showers, connectors, tub spout, etc. Available in different finishes and sizes.

- Shower head
- Thin design (5mm / 0.2 in.)
- G 1/2 in. inlet
- Silicone sharp nozzles easy to clean
- 1.8 Gpm
- Rustproof: Yes

Material

- Premium material construction with metal handle ensures reliability and durability.
- BATHONOMY finishes resist corrosion and tarnishing.
- Stainless steel construction

Dimensions

- H: 0.2" * / Ø: 8"

Weight

- 2.2 lb.



Codes/Standards

COF.SHH.MTO.08.00.SS.PSS

BATHONOMY Faucet Lifetime Limited Warranty

See website for detailed warranty information.

Available Colors/Finishes

Color tiles intended for reference only.

Color Code Description

Color	Code	Description
	BSS	Brushed Stainless Steel
	MBL	Matt Black
	PSS	Polished Stainless Steel
	SBR	Satin Brass



Codes / Standards compliance: Uniform Plumbing Code (UPC)

National Plumbing Code of Canada

ASME A112.18.1-2018 / CSA B125.1-18 / ASSE 1016

IAPMO file number: 8659 (for more info visit: <http://pld.iapmo.org/default.aspx>)

SKU for iapmo search LTA1010



bathonomy ShowerHead

Metro

Sharp Nozzles Shower Head Wall
Or Ceiling Mount - 8"

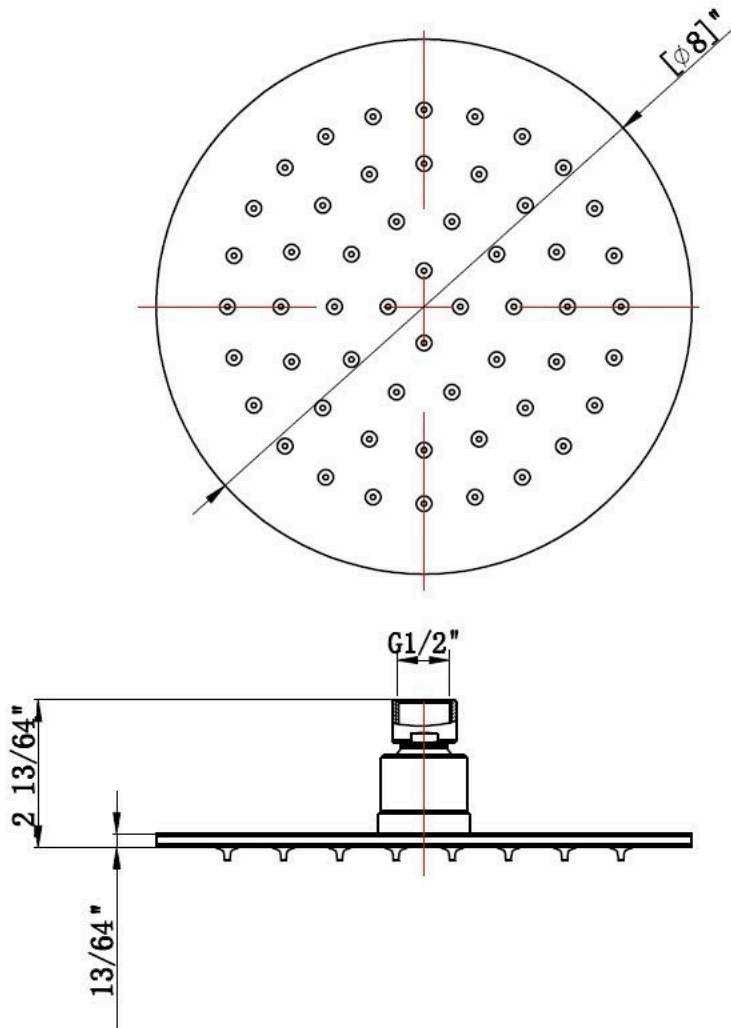

Technical Information

All product dimensions are nominal.

Notes

Install the product according to the installation guide.



bathonomyHandShowerConnetor

Metro

Hand Shower Holder
Connetor Wall Mount - 3"

Features

Modern hand shower hose holder with connector of our Metro family, a family of components for your shower with a round and modern design that will delight your daily shower. This family covers everything you need to build your bathroom area: mixers, heads, hand showers, connectors, tub spout, etc. Available in different finishes and functions.

- Hose connector with holder
- Adjustable scutcheon
- NPT 1/2 in. inlet
- G 1/2 in. outlet



Material

- Premium material construction with metal handle ensures reliability and durability.
- BATHONOMY finishes resist corrosion and tarnishing.
- Brass construction

Dimensions

- W: 2.87" * H: 2.37" * D: 3.12" / Ø: 1.25"

Weight

- 1.0 lb.

Codes/Standards

COF.HHC.MTO.03.00.BR.PCH

BATHONOMY Faucet Lifetime Limited Warranty

See website for detailed warranty information.

Available Colors/Finishes

Color tiles intended for reference only.

Color	Code	Description
	BNI	Brushed Nickel
	MBL	Matt Black
	PCH	Polished Chrome
	SBR	Satin Brass



Codes / Standards compliance: Uniform Plumbing Code (UPC)
National Plumbing Code of Canada
ASME A112.18.1-2018 / CSA B125.1-18 / ASSE 1016
IAPMO file number: 8659 (for more info visit: <http://pld.iapmo.org/default.aspx>)
SKU for iapmo search LTA1010



bathonomyHandShowerConnector

Metro

Hand Shower Holder
Connector Wall Mount - 3"

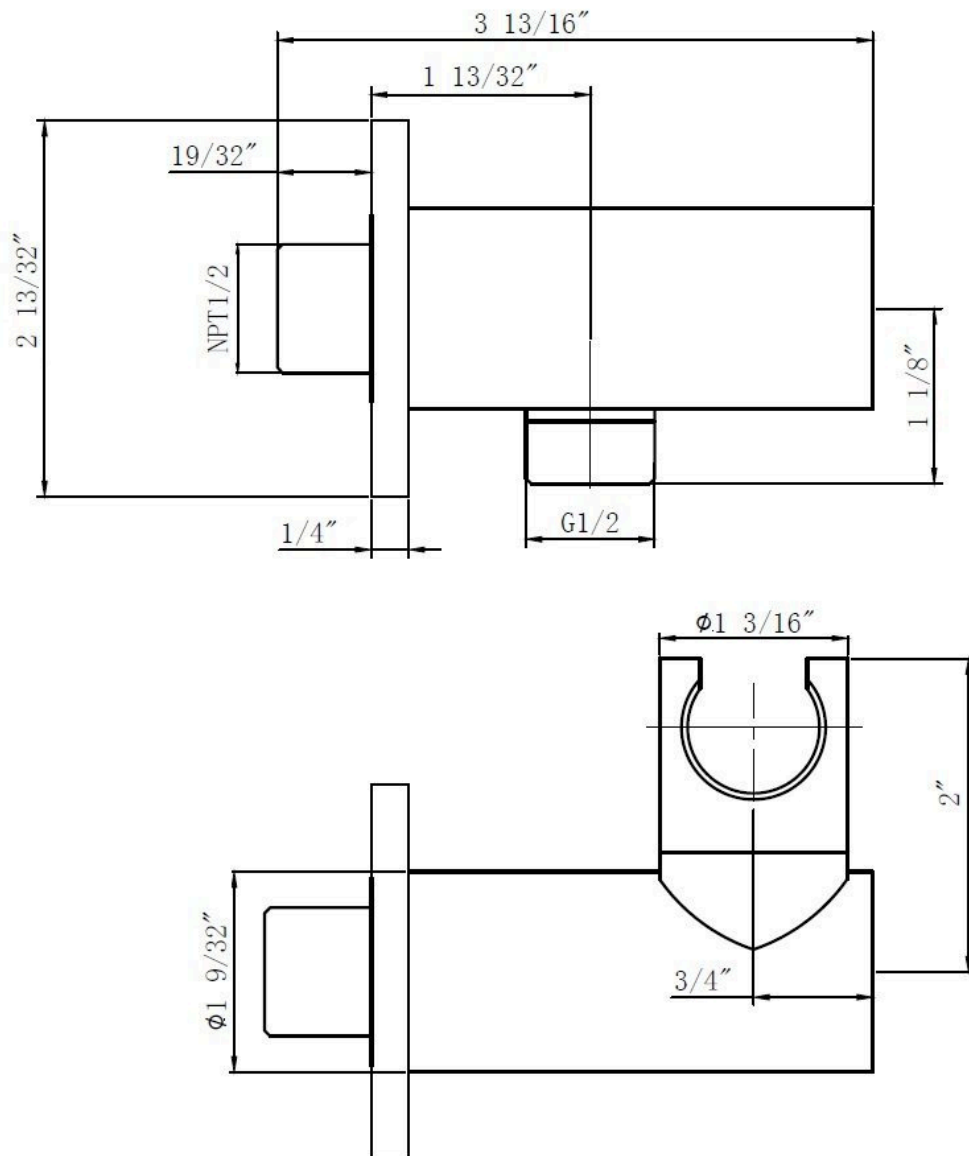

Technical Information

All product dimensions are nominal.

Notes

Install the product according to the installation guide.



bathonomy ShowerHose

ShowerComplements

Hand Shower Hose
Wall Mount - 5"

Features

Traditional and modern hand shower hose of our Shower Complements family, a family of components where you will find what you need to complete the installation of your shower. Available in different finishes.

- Hand shower hose
- 60 in. length
- Round connector on each end.
- Rubber washer on the bracket connector to prevent slipping.
- NPT 1/2 in. inlet and outlet connections.

Material

- Premium material construction with metal handle ensures reliability and durability.
- BATHONOMY finishes resist corrosion and tarnishing.
- Stainless steel construction

Dimensions

- W: 120" * / Ø: 0.5"

Weight

- 0.3 lb.



Codes/Standards





COF.HHO.SCO.05.00.SS.PCH

BATHONOMY Faucet Lifetime Limited Warranty

See website for detailed warranty information.

Available Colors/Finishes

Color tiles intended for reference only.

Color	Code	Description
	BNI	Brushed Nickel
	MBL	Matt Black
	PCH	Polished Chrome
	SBR	Satin Br



Codes / Standards compliance: Uniform Plumbing Code (UPC)
 National Plumbing Code of Canada
 ASME A112.18.1-2018 / CSA B125.1-18 / ASSE 1016
 IAPMO file number: 8659 (for more info visit: <http://pld.iapmo.org/default.aspx>)
 SKU for iapmo search LTA1010



bathonomyHandShower

Metro

Hand Shower
Wall Mount - 1"

Features

Modern hand shower of our Metro family, a family of components for your shower with a round and modern design that will delight your daily shower. This family covers everything you need to build your bathroom area: mixers, heads, tubes, connectors, tub spout, etc. Available in different finishes and function.

- Hand shower
- Only rain function
- 1.8 Gpm.
- G 1/2" inlet

Material

- Premium material construction with metal handle ensures reliability and durability.
- BATHONOMY finishes resist corrosion and tarnishing.
- Brass construction
- Silicone sharp nozzle easy to clean.

Dimensions

- H: 9" * / Ø: 0.93"

Weight

- 0.6 lb.



Codes/Standards



COF.HSH.MTO.01.00.BR.PCH

BATHONOMY Faucet Lifetime Limited Warranty

See website for detailed warranty information.

Available Colors/Finishes

Color tiles intended for reference only.

Color	Code	Description
	BNI	Brushed Nickel
	MBL	Matt Black
	PCH	Polished Chrome
	SBR	Satin Brass



Codes / Standards compliance: Uniform Plumbing Code (UPC)
 National Plumbing Code of Canada
 ASME A112.18.1-2018 / CSA B125.1-18 / ASSE 1016
 IAPMO file number: 8659 (for more info visit: <http://pld.iapmo.org/default.aspx>)
 SKU for iapmo search LTA1010



bathonomy HandShower

Metro

Hand Shower
Wall Mount - 1"

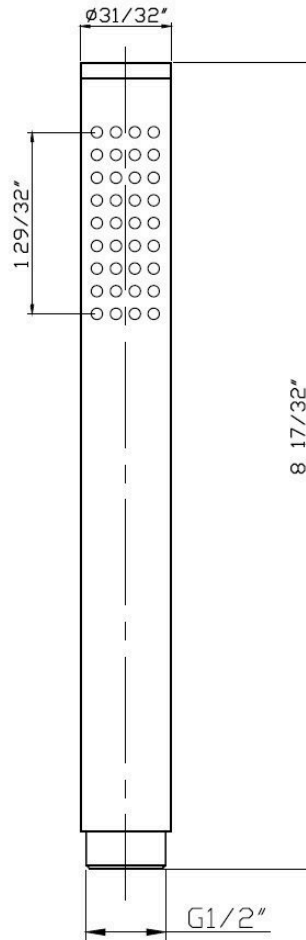

Technical Information

All product dimensions are nominal.

Notes

Install the product according to the installation guide.



bathonomy Shower Mixer

Metro

2 Way Pressure Balance Shower Mixer - Wall Mount - 2"

Features

- Pressure balance rough-in valve with 2 way diverter.
 - Two way selectable through a diverter
- Shut-off valves and integrated anti-return valves.
 - Temperature and flow limiter incorporated in cartridge.
- Pressure balance cartridge adjust inlet pressure fluctuations.
- Pressure balance cartridge prevent scalding, cold water supply stops when cold water pressure fail.
- Maximun outlet temperature and flow can be limited.
- Minimun working pressure: 20 Psi (1.4 Bar).
- Maximun working pressure: 125 Psi (8 bar).
- Recommended working pressure: 45 Psi (3 Bar).
- Maximun test pressure: 500 Psi (35 Bar)
- Hot water inlet max. temperature: 180°F (80°C)
- Water inlet and outlet threads: Male 1/2 in. NPT



Codes/Standards

COF.SHM.MTO.02.00.BR.PCH





BATHONOMY Faucet Lifetime Limited Warranty

See website for detailed warranty information.

Available Colors/Finishes

Color tiles intended for reference only.

Color Code Description

	BNI	Brushed Nickel
	MBL	Matt Black
	PCH	Polished Chrome
	SBR	Satin Brass

Material

- Premium material construction with metal handle ensures reliability and durability.
- BATHONOMY finishes resist corrosion and tarnishing.
- Brass

Dimensions

- D: 3" * Ø: 6.5"

Weight

- 4.1 lb.

Codes / Standards compliance:



Uniform Plumbing Code (UPC)
National Plumbing Code of Canada
ASME A112.18.1-2018 / CSA
B125.1-18 / ASSE 1016



IAPMO file number: 8659 (for more info visit: <http://pld.iapmo.org/default.aspx>)

SKU for iapmo search LTA1010



bathonomy ShowerMixer

Metro

2 Way Pressure Balance Shower Mixer - Wall Mount - 2"

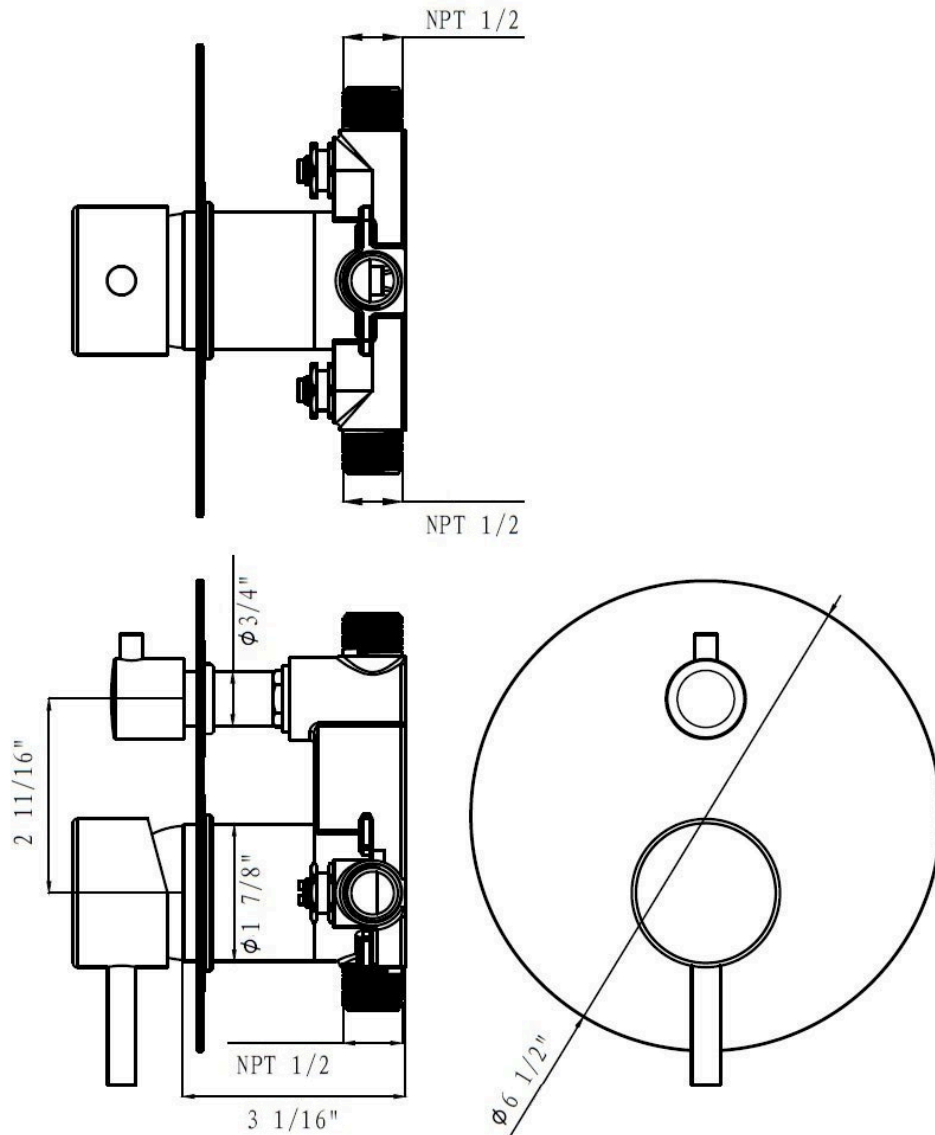

Technical Information

All product dimensions are nominal.

Shower head included: No

Shower arm: No

Notes

Install the product according to the installation guide.