



bathonomy

ASME A112.18.1 / CSA B125.1
NSF61, NSF372



Devon 2-Way Sliding Bar And Head Included Complete Shower Set - Wall Mount - 8" Brass/Brushed Nickel

COMPONENTS:

- Shower arm wall mount 16 in. length.
- Shower head 8 in. design with sharp nozzles.
- Sliding bar.
- Shower mixer rough-in valve with trim.
- Hose connector.
- Hose 5 feet.
- Hand shower square with square silicone nozzles.



Working pressure:

- Min: 20 PSI (1.5 bar)
- Max: 125 PSI (8 bar)
- Recommended: 45 PSI (3 bar)
- Hot water inlet max. temperature: 180 °F (80 °C)
- Water inlet threads: 1/2 NPT male
- Full brass

Connector features:

- Square design.
- NPT 1/2 in. inlet. G 1/2 in. outlet

Hose features:

- Length 60 in.
- Stainless Steel construction.
- NPT 1/2 in. inlet

Hand shower features:

- Square design.
- Only rain function.
- 1.8 Gpm
- G1/2 in. Inlet.
- Silicone square nozzles easy to clean.
- ABS construction.

Shower head features:

- Thin design (0.2 in. / 5 mm)
- G 1/2 in. female inlet
- Full rain spray single function
- 1.8 Gpm @ 80 PSI
- Silicone sharp nozzles easy to clean
- Made in stainless steel.

Shower arm features:

- Wall mount.
- NPT 1/2 in. inlet . G 1/2 in. outlet
- 16" length
- Fixed scutcheon
- Full brass construction.

Sliding bar features:

- Made in full brass
- Support for hand shower adjustable in height and inclination.
- Material: Brass
- Finish/Color: Brushed Nickel

Dimensions:

- Weight: 12.3 lb.

COLOR CODE DESCRIPTION



BNI BRUSHED
NICKEL



bathonomy Shower Arm

Devon

Devon Shower Arm
Wall Mount - 15"

Features

Modern shower arm of our Devon family, a family of components for your shower with a square and modern design that will delight your daily shower. This family covers everything you need to build your bathroom area: mixers, heads, hand showers, connectors, tub spout, etc. Available in different finishes and functions.

- Shower arm.
- NPT 1/2 in. inlet
- G 1/2 in. outlet
- Rustproof: Yes

Material

- Premium material construction with metal handle ensures reliability and durability.
- BATHONOMY finishes resist corrosion and tarnishing.
- Brass construction

Dimensions

- W: 1" * H: 2.75" * D: 15.75"

Weight

- 1.5 lb.



Codes/Standards

COF.SHA.DEV.15.75.BR.BNI

BATHONOMY Faucet Lifetime Limited Warranty

See website for detailed warranty information.

Available Colors/Finishes

Color tiles intended for reference only.

Color	Code	Description
	BNI	Brushed Nickel
	MBL	Matt Black
	PCH	Polished Chrome
	SBR	Satin Brass



Codes / Standards compliance: Uniform Plumbing Code (UPC)
 National Plumbing Code of Canada
 ASME A112.18.1-2018 / CSA B125.1-18 / ASSE 1016
 IAPMO file number: 8659 (for more info visit: <http://pld.iapmo.org/default.aspx>)
 SKU for iapmo search LTA1010



bathonomy ShowerArm

Devon

Devon Shower Arm
Wall Mount - 15"

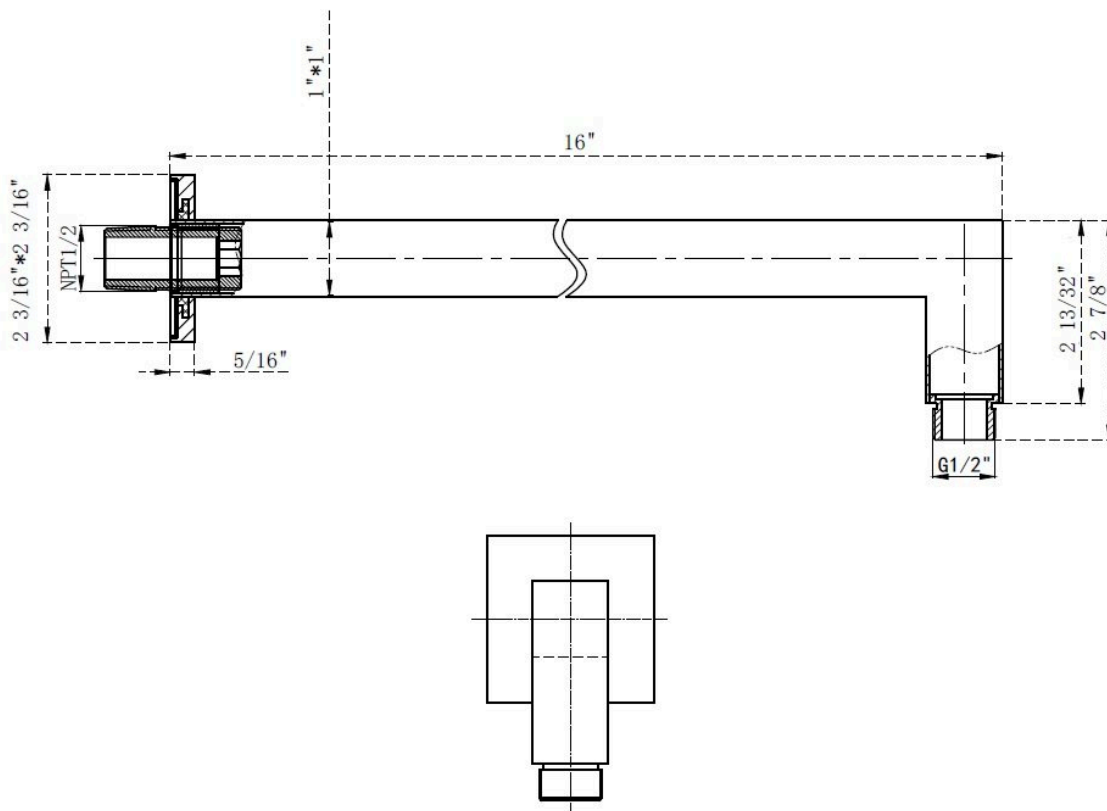

Technical Information

All product dimensions are nominal.

Notes

Install the product according to the installation guide.



bathonomy ShowerHead

Devon

Sharp Nozzles Shower Head Wall
Or Ceiling Mount - 8"

Features

Modern shower head of our Devon family, a family of components for your shower with a square and modern design that will delight your daily shower. This family covers everything you need to build your bathroom area: mixers, heads, hand showers, connectors, tub spout, etc. Available in different finishes and sizes.

- Shower head
- Thin design (5mm / 0.2 in.)
- G 1/2 in. inlet
- Silicone sharp nozzles easy to clean
- 1.8 Gpm
- Rustproof: Yes

Material

- Premium material construction with metal handle ensures reliability and durability.
- BATHONOMY finishes resist corrosion and tarnishing.
- Stainless steel construction

Dimensions

- W: 8" * H: 0.2" * D: 8"

Weight

- 2.4 lb.

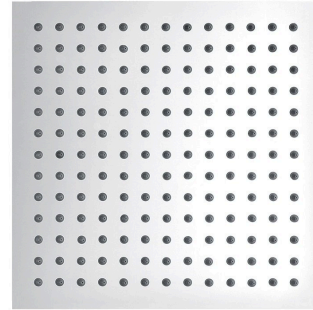

Codes/Standards

COF.SHH.DEV.08.00.SS.BSS

BATHONOMY Faucet Lifetime Limited Warranty

See website for detailed warranty information.

Available Colors/Finishes

Color tiles intended for reference only.

Color Code Description

Color	Code	Description
	BSS	Brushed Stainless Steel
	MBL	Matt Black
	PSS	Polished Stainless Steel
	SBR	Satin Brass



Codes / Standards compliance: Uniform Plumbing Code (UPC)

National Plumbing Code of Canada

ASME A112.18.1-2018 / CSA B125.1-18 / ASSE 1016

IAPMO file number: 8659 (for more info visit: <http://pld.iapmo.org/default.aspx>)

SKU for iapmo search LTA1010



bathonomy ShowerHead

Devon

Sharp Nozzles Shower Hea Wall
Or Ceiling Mount - 8"

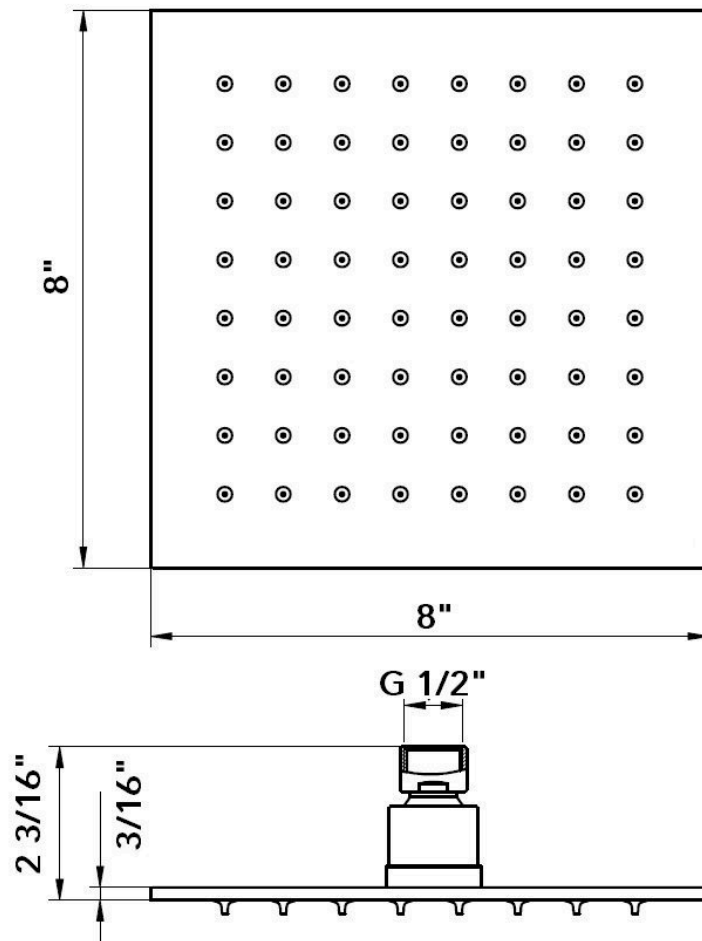

Technical Information

All product dimensions are nominal.

Notes

Install the product according to the installation guide.



bathonomyHandShower

Luk 2

Hand Shower Column - Wall Mount - 27"

Features

Shower bar without accessories Luk 2 family. Made in full brass this bar will make your shower look like the first day resisting the passage of time. It has of support for the hand shower adjustable in height and with head adjustable in inclination. Complete this bar with the necessary accessories from our Luk 2 or Cubic series. Available in different finishes.

- Support for hand shower adjustable in height and inclination.
- Made in full brass.
- You need to complete this product with hose, connector and hand shower.

Material

- Premium material construction with metal handle ensures reliability and durability.
- BATHONOMY finishes resist corrosion and tarnishing.
- Brass construction
- Silicone sharp nozzle easy to clean.

Dimensions

- W: 5.25" * H: 27.5" * D: 3"

Weight

- 2.7 lb.



Codes/Standards

JUM.HCL.LUK.27.00.BR.BNI





BATHONOMY Faucet Lifetime Limited Warranty

See website for detailed warranty information.

Available Colors/Finishes

Color tiles intended for reference only.

Color Code Description

	BNI	Brushed Nickel
	MBL	Matt Black
	PCH	Polished Chrome
	SBR	Satin Brass



Codes / Standards compliance: Uniform Plumbing Code (UPC)

National Plumbing Code of Canada

ASME A112.18.1-2018 / CSA B125.1-18 / ASSE 1016

IAPMO file number: 8659 (for more info visit: <http://pld.iapmo.org/default.aspx>)

SKU for iapmo search LTA1010



bathonomy HandShower

Luk 2

Hand Shower Column - Wall Mount -
27"

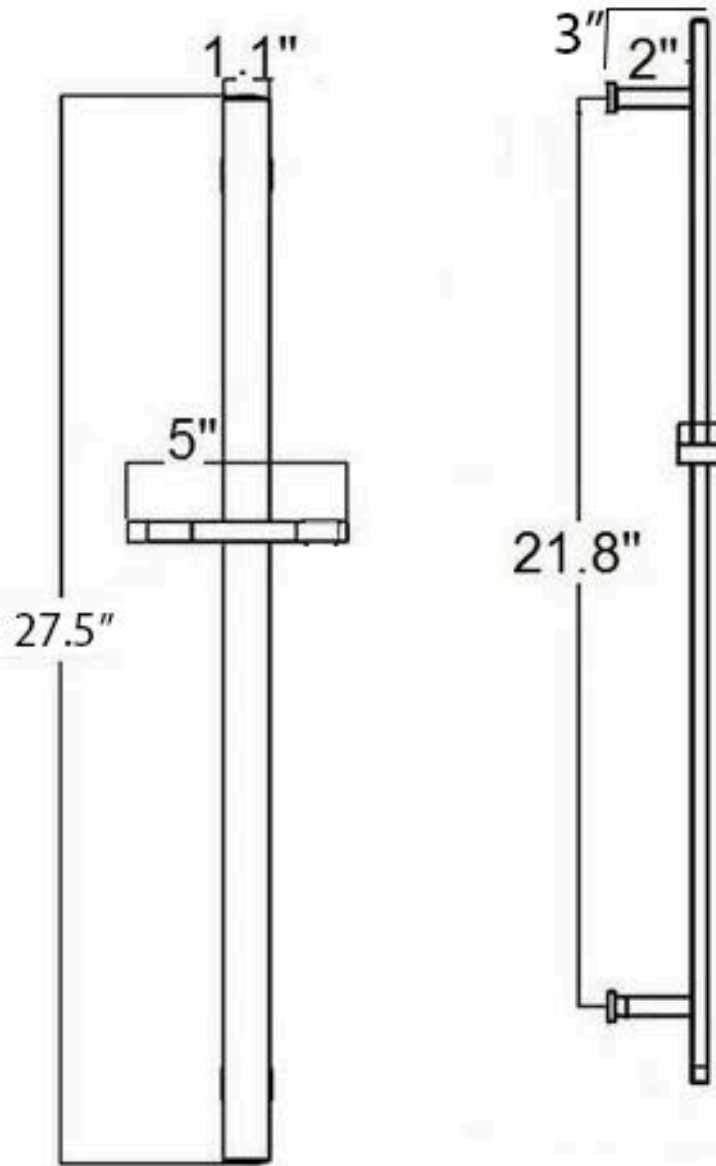

Technical Information

All product dimensions are nominal.

Notes

Install the product according to the installation guide.



bathonomy Shower Mixer

Devon

2 Way Pressure Balance Shower Mixer - Wall Mount - 2"

Features

- Pressure balance rough-in valve with 2 way diverter.
 - Two way selectable through a diverter
- Shut-off valves and integrated anti-return valves.
 - Temperature and flow limiter incorporated in cartridge.
- Pressure balance cartridge adjust inlet pressure fluctuations.
- Pressure balance cartridge prevent scalding, cold water supply stops when cold water pressure fail.
- Maximun outlet temperature and flow can be limited.
- Minimun working pressure: 20 Psi (1.4 Bar).
- Maximun working pressure: 125 Psi (8 bar).
- Recommended working pressure: 45 Psi (3 Bar).
- Maximun test pressure: 500 Psi (35 Bar)
- Hot water inlet max. temperature: 180°F (80°C)
- Water inlet and outlet threads: Male 1/2 in. NPT

Material

- Premium material construction with metal handle ensures reliability and durability.
- BATHONOMY finishes resist corrosion and tarnishing.
- Brass

Dimensions

- W: 5.31" * H: 6.31" * D: 3"

Weight

- 4.4 lb.



Codes/Standards

COF.SHM.DEV.02.00.BR.BNI





BATHONOMY Faucet Lifetime Limited Warranty

See website for detailed warranty information.

Available Colors/Finishes

Color tiles intended for reference only.

Color Code Description

	BNI	Brushed Nickel
	MBL	Matt Black
	PCH	Polished Chrome
	SBR	Satin Brass

Codes / Standards compliance:



Uniform Plumbing Code (UPC)
National Plumbing Code of Canada
ASME A112.18.1-2018 / CSA
B125.1-18 / ASSE 1016



IAPMO file number: 8659 (for more info visit: <http://pld.iapmo.org/default.aspx>)

SKU for iapmo search LTA1010



bathonomy ShowerMixer

Devon

2 Way Pressure Balance Shower Mixer - Wall Mount - 2"

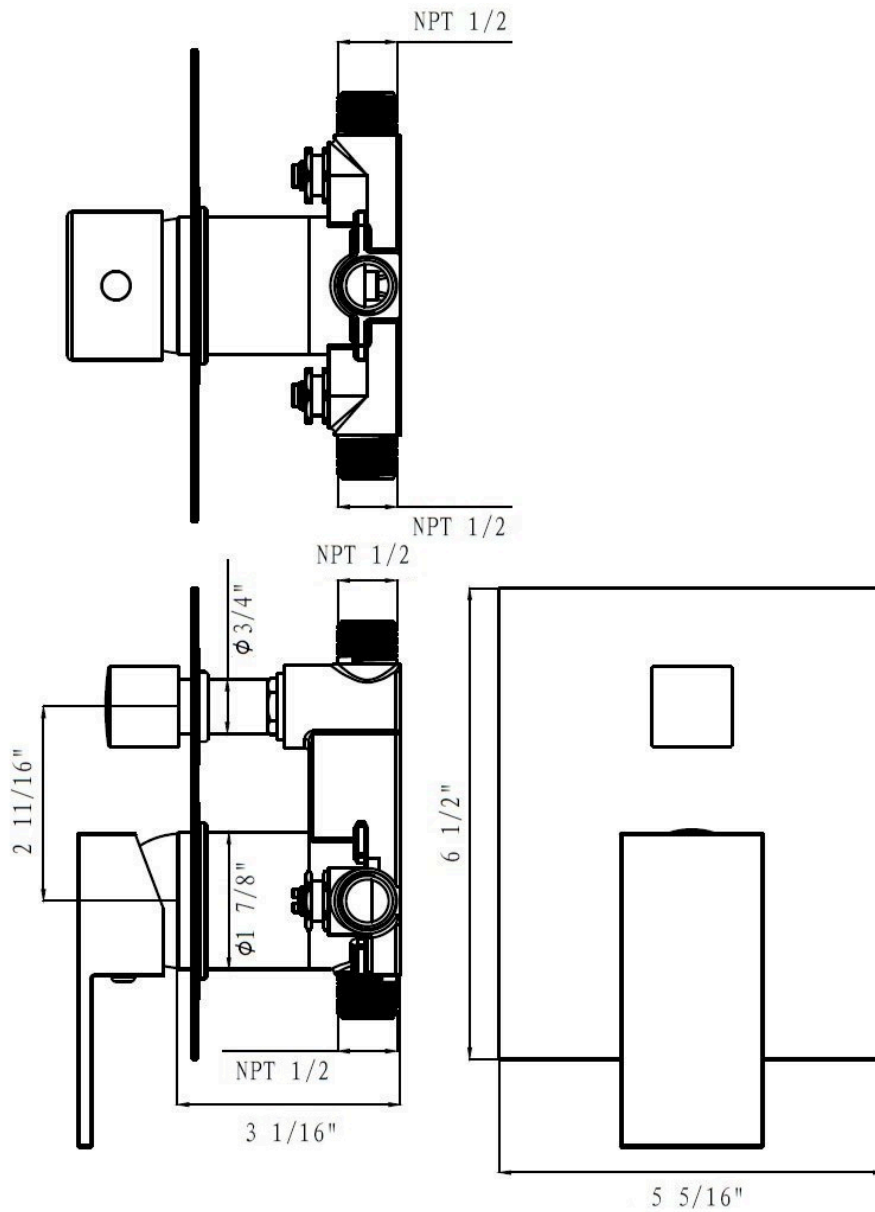

Technical Information

All product dimensions are nominal.

Shower head included: No

Shower arm: No

Notes

Install the product according to the installation guide.



bathonomyHandShowerConnetor

Devon

Hand Shower Connetor
Wall Mount - 1"

Features

Modern hand shower hose connector of our Devon family, a family of components for your shower with a square and modern design that will delight your daily shower. This family covers everything you need to build your bathroom area: mixers, heads, hand showers, connectors, tub spout, etc. Available in different finishes and functions.

- Hose connector
- Fixed scutcheon, cannot be adjusted
- NPT 1/2 in. inlet
- G 1/2 in. outlet



Material

- Premium material construction with metal handle ensures reliability and durability.
- BATHONOMY finishes resist corrosion and tarnishing.
- Brass construction

Dimensions

- W: 2" * H: 2" * D: 1.87"

Weight

- 0.9 lb.

Codes/Standards





COF.HCO.DEV.02.00.BR.BNI

BATHONOMY Faucet Lifetime Limited Warranty

See website for detailed warranty information.

Available Colors/Finishes

Color tiles intended for reference only.

Color	Code	Description
	BNI	Brushed Nickel
	MBL	Matt Black
	PCH	Polished Chrome
	SBR	Satin Brass



Codes / Standards compliance: Uniform Plumbing Code (UPC)
 National Plumbing Code of Canada
 ASME A112.18.1-2018 / CSA B125.1-18 / ASSE 1016
 IAPMO file number: 8659 (for more info visit: <http://pld.iapmo.org/default.aspx>)
 SKU for iapmo search LTA1010



bathonomyHandShowerConnetor

Devon

Hand Shower Connetor
Wall Mount - 1"

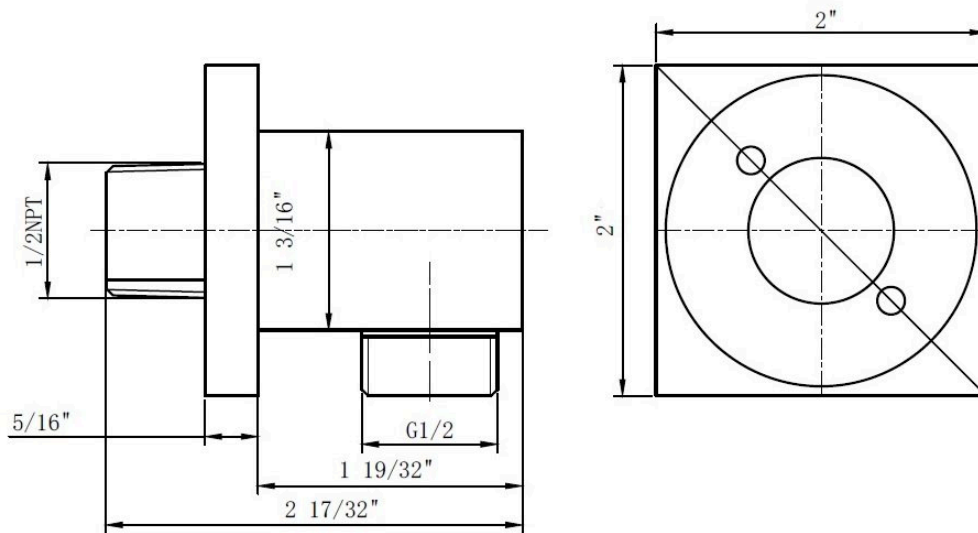

Technical Information

All product dimensions are nominal.

Notes

Install the product according to the installation guide.



bathonomy ShowerHose

ShowerComplements

Hand Shower Hose
Wall Mount - 5"

Features

Traditional and modern hand shower hose of our Shower Complements family, a family of components where you will find what you need to complete the installation of your shower. Available in different finishes.

- Hand shower hose
- 60 in. length
- Round connector on each end.
- Rubber washer on the bracket connector to prevent slipping.
- NPT 1/2 in. inlet and outlet connections.

Material

- Premium material construction with metal handle ensures reliability and durability.
- BATHONOMY finishes resist corrosion and tarnishing.
- Stainless steel construction

Dimensions

- W: 120" * / Ø: 0.5"

Weight

- 0.3 lb.



Codes/Standards

COF.HHO.SCO.05.00.SS.BNI

BATHONOMY Faucet Lifetime Limited Warranty

See website for detailed warranty information.

Available Colors/Finishes

Color tiles intended for reference only.

Color	Code	Description
	BNI	Brushed Nickel
	MBL	Matt Black
	PCH	Polished Chrome
	SBR	Satin Br



Codes / Standards compliance: Uniform Plumbing Code (UPC)
 National Plumbing Code of Canada
 ASME A112.18.1-2018 / CSA B125.1-18 / ASSE 1016
 IAPMO file number: 8659 (for more info visit: <http://pld.iapmo.org/default.aspx>)
 SKU for iapmo search LTA1010



bathonomyHandShower

Devon

Hand Shower
Wall Mount - 1"

Features

Modern hand shower of our Devon family, a family of components for your shower with a square and modern design that will delight your daily shower. This family covers everything you need to build your bathroom area: mixers, heads, tubes, connectors, tub spout, etc. Available in different finishes and functions.

- Hand shower
- Only rain function
- 1.8 Gpm.
- G 1/2" inlet

Material

- Premium material construction with metal handle ensures reliability and durability.
- BATHONOMY finishes resist corrosion and tarnishing.
- Brass construction
- Silicone sharp nozzle easy to clean.

Dimensions

- W: 1.12" * H: 8.25" * D: 1.12"

Weight

- 0.3 lb.



Codes/Standards

COF.HSH.DEV.01.00.AB.BNI

BATHONOMY Faucet Lifetime Limited Warranty

See website for detailed warranty information.

Available Colors/Finishes

Color tiles intended for reference only.

Color	Code	Description
	BNI	Brushed Nickel
	MBL	Matt Black
	PCH	Polished Chrome
	SBR	Satin Brass



Codes / Standards compliance: Uniform Plumbing Code (UPC)
 National Plumbing Code of Canada
 ASME A112.18.1-2018 / CSA B125.1-18 / ASSE 1016
 IAPMO file number: 8659 (for more info visit: <http://pld.iapmo.org/default.aspx>)
 SKU for iapmo search LTA1010



bathonomy HandShower

Devon

Hand Shower
Wall Mount - 1"

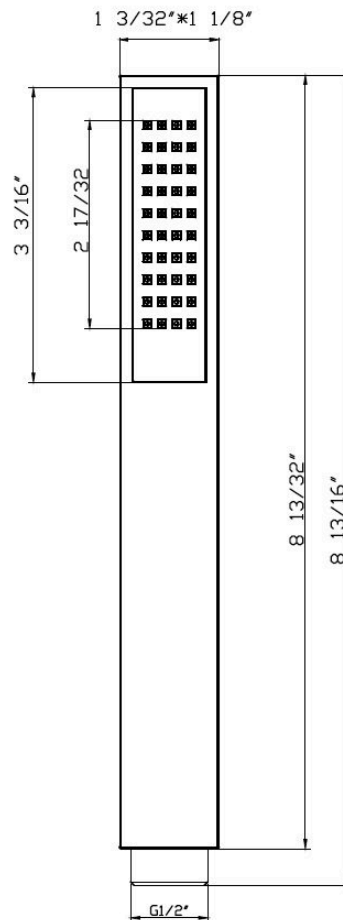

Technical Information

All product dimensions are nominal.

Notes

Install the product according to the installation guide.