



bathonomy

ASME A112.18.1 / CSA B125.1
NSF61, NSF372



Devon 3-Way Hand Shower And Waterfall Head Included Complete Shower Set - Wall Mount - 10" Brass/Matt Black



COMPONENTS:

- Double function shower head with rain and waterfall.
- Hand shower holder connector.
- Hose.
- Hand shower square design.
- Shower mixer rough-in valve with trim.

Working pressure:

- Min: 20 PSI (1.5 bar)
- Max: 125 PSI (8 bar)
- Recommended: 45 PSI (3 bar)
- Hot water inlet max. temperature: 180 °F (80 °C)
- Water inlet threads: 1/2 NPT female
- Full brass

Shower head features:

- Waterfall and rain shower.
- 1/2" NPT male inlet for each function
- 2 functions, needs premixed water
- 4 Gpm @ 80 PSI / 15 L/min @ 522 kPa
- Silicone nozzles easy to clean in rain function
- Made in stainless steel.

Connector features:

- Rectangular design with holder for hand shower.
- NPT 1/2 in. inlet. G 1/2 in. outlet

Hose features:

- Length 60 in.
- Stainless Steel construction.
- NPT 1/2 in. inlet

Hand shower features:

- Square design.
- Only rain function.
- 1.8 Gpm
- G1/2 in. Inlet.
- Silicone square nozzles easy to clean.
- ABS construction.
- Material: Brass
- Finish/Color: Brushed Nickel

Dimensions:

- Weight: 18.8 lb.

COLOR CODE DESCRIPTION



MBL MATT BLACK



bathonomy ShowerHead

Devon

Double Function Shower Head
Wall Mount - 10"

Features

Devon family double-function shower head, a family of harmonious aesthetics that decorates the bathroom space with defined classic lines that adapt to the urban style. This family covers everything you need to build your bathroom area: mixers, heads, hand showers, connectors, tub spouts, etc. Simple pieces in a compact form that incorporates refined finishes that make this work an exclusive column. Its innovative thermostatic valve design improves the functionality of continuous use. Available in different finishes.

- Suggested room fit: Showers
- Waterfall and rain shower.
- 1/2" NPT male inlet for each function
- 2 functions, needs premixed water
- 4 Gpm @ 80 PSI / 15 L/min @ 522 kPa
- Silicone nozzles easy to clean in rain function

Material

- Premium material construction with metal handle ensures reliability and durability.
- BATHONOMY finishes resist corrosion and tarnishing.
- Brass construction

Dimensions

- W: 9" * H: 1.25" * D: 19.75"

Weight

- 7.7 lb.



Codes/Standards

COF.SHH.DEV.10.00.SS.MBL

BATHONOMY Faucet Lifetime Limited Warranty

See website for detailed warranty information.

Available Colors/Finishes

Color tiles intended for reference only.

Color	Code	Description
	BSS	Brushed Stainless Steel
	MBL	Matt Black
	<u>PSS</u>	Polished Stainless Steel
	SBR	Satin Brass



Codes / Standards compliance: Uniform Plumbing Code (UPC)
 National Plumbing Code of Canada
 ASME A112.18.1-2018 / CSA B125.1-18 / ASSE 1016
 IAPMO file number: 8659 (for more info visit: <http://pld.iapmo.org/default.aspx>)
 SKU for iapmo search LTA1010



bathonomy ShowerArm

Devon

Double Function Shower Head
Wall Mount - 10"

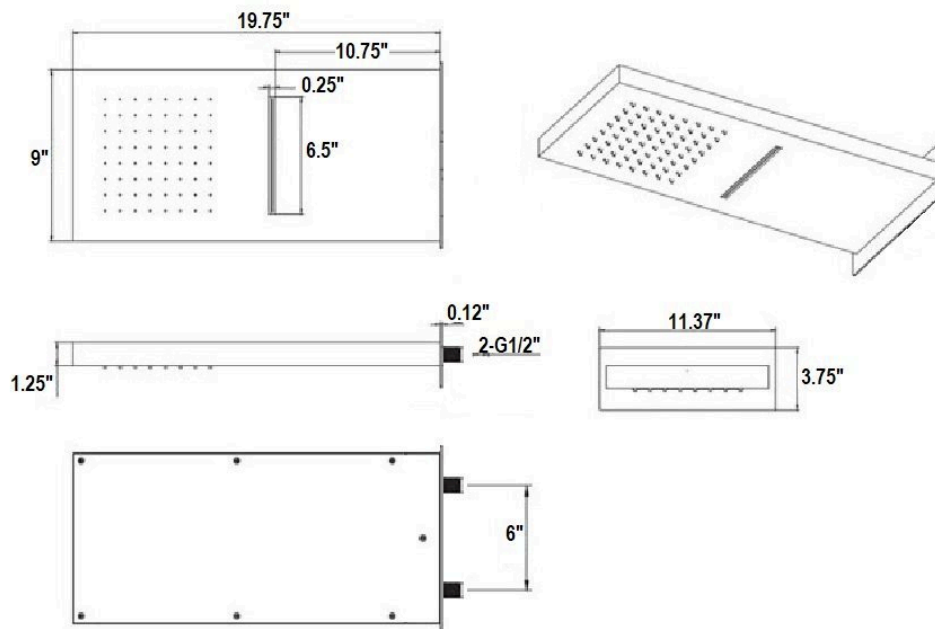

Technical Information

All product dimensions are nominal.

Notes

Install the product according to the installation guide.



bathonomyHandShowerConnector

Devon

Hand Shower Holder
Connector Wall Mount - 3"

Features

Modern hand shower hose holder with connector of our Devon family, a family of components for your shower with a square and modern design that will delight your daily shower. This family covers everything you need to build your bathroom area: mixers, heads, hand showers, connectors, tub spout, etc. Available in different finishes and functions.

- Hose connector with holder
- Adjustable scutcheon
- NPT 1/2 in. inlet
- G 1/2 in. outlet



Material

- Premium material construction with metal handle ensures reliability and durability.
- BATHONOMY finishes resist corrosion and tarnishing.
- Brass construction

Dimensions

- W: 3" * H: 2.36" * D: 3.25"

Weight

- 1.7 lb.

Codes/Standards

COF.HHC.DEV.03.00.BR.MBL





BATHONOMY Faucet Lifetime Limited Warranty

See website for detailed warranty information.

Available Colors/Finishes

Color tiles intended for reference only.

Color Code Description

	BNI	Brushed Nickel
	MBL	Matt Black
	PCH	Polished Chrome
	SBR	Satin Brass



Codes / Standards compliance: Uniform Plumbing Code (UPC)

National Plumbing Code of Canada

ASME A112.18.1-2018 / CSA B125.1-18 / ASSE 1016

IAPMO file number: 8659 (for more info visit: <http://pld.iapmo.org/default.aspx>)

SKU for iapmo search LTA1010



bathonomyHandShowerConnector

Devon

Hand Shower Holder
Connector Wall Mount - 3"

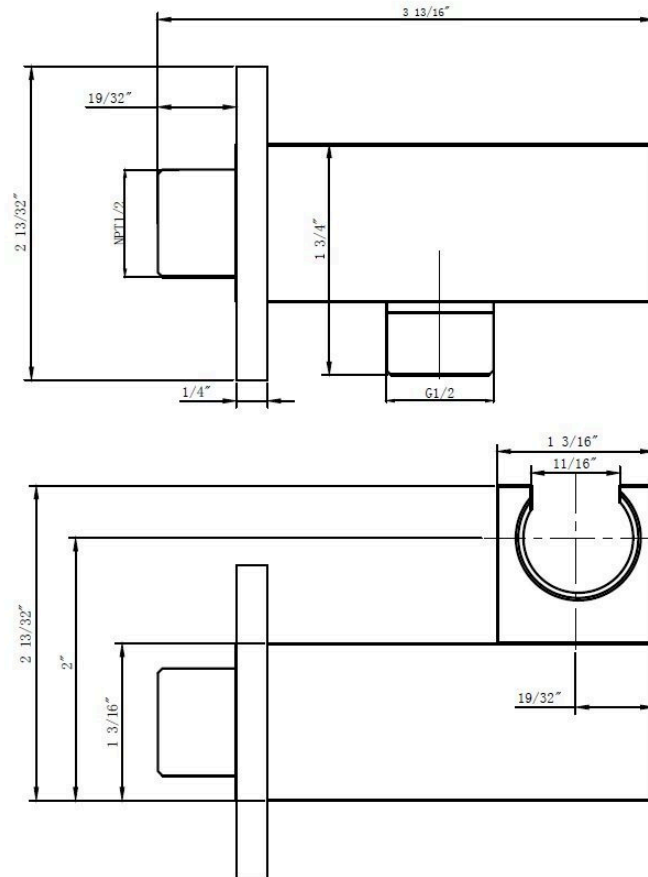

Technical Information

All product dimensions are nominal.

Notes

Install the product according to the installation guide.



bathonomy ShowerHose

ShowerComplements

Hand Shower Hose
Wall Mount - 5"

Features

Traditional and modern hand shower hose of our Shower Complements family, a family of components where you will find what you need to complete the installation of your shower. Available in different finishes.

- Hand shower hose
- 60 in. length
- Round connector on each end.
- Rubber washer on the bracket connector to prevent slipping.
- NPT 1/2 in. inlet and outlet connections.

Material

- Premium material construction with metal handle ensures reliability and durability.
- BATHONOMY finishes resist corrosion and tarnishing.
- Stainless steel construction

Dimensions

- W: 120" * / Ø: 0.5"

Weight

- 0.3 lb.



Codes/Standards

COF.HHO.SCO.05.00.SS.MBL

BATHONOMY Faucet Lifetime Limited Warranty

See website for detailed warranty information.

Available Colors/Finishes

Color tiles intended for reference only.

Color	Code	Description
	BNI	Brushed Nickel
	MBL	Matt Black
	PCH	Polished Chrome
	SBR	Satin Br



Codes / Standards compliance: Uniform Plumbing Code (UPC)
 National Plumbing Code of Canada
 ASME A112.18.1-2018 / CSA B125.1-18 / ASSE 1016
 IAPMO file number: 8659 (for more info visit: <http://pld.iapmo.org/default.aspx>)
 SKU for iapmo search LTA1010



bathonomyHandShower

Devon

Hand Shower
Wall Mount - 1"

Features

Modern hand shower of our Devon family, a family of components for your shower with a square and modern design that will delight your daily shower. This family covers everything you need to build your bathroom area: mixers, heads, tubes, connectors, tub spout, etc. Available in different finishes and functions.

- Hand shower
- Only rain function
- 1.8 Gpm.
- G 1/2" inlet

Material

- Premium material construction with metal handle ensures reliability and durability.
- BATHONOMY finishes resist corrosion and tarnishing.
- Brass construction
- Silicone sharp nozzle easy to clean.

Dimensions

- W: 1.12" * H: 8.25" * D: 1.12"

Weight

- 0.3 lb.

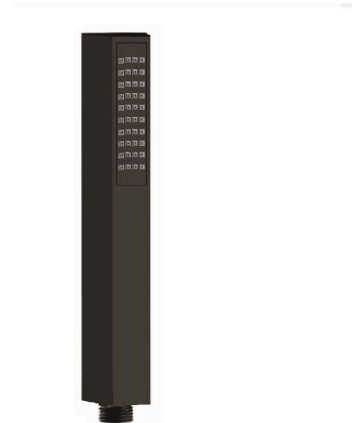

Codes/Standards

COF.HSH.DEV.01.00.AB.MBL

BATHONOMY Faucet Lifetime Limited Warranty

See website for detailed warranty information.

Available Colors/Finishes

Color tiles intended for reference only.

Color	Code	Description
	BNI	Brushed Nickel
	MBL	Matt Black
	PCH	Polished Chrome
	SBR	Satin Brass



Codes / Standards compliance: Uniform Plumbing Code (UPC)
 National Plumbing Code of Canada
 ASME A112.18.1-2018 / CSA B125.1-18 / ASSE 1016
 IAPMO file number: 8659 (for more info visit: <http://pld.iapmo.org/default.aspx>)
 SKU for iapmo search LTA1010



bathonomy HandShower

Devon

Hand Shower
Wall Mount - 1"

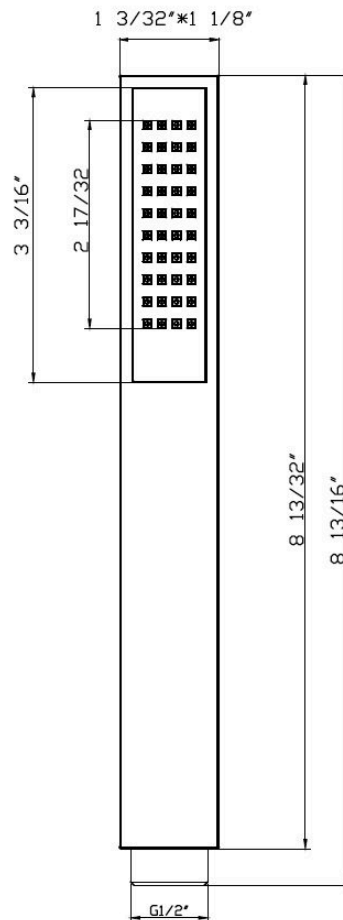

Technical Information

All product dimensions are nominal.

Notes

Install the product according to the installation guide.



bathonomy Shower Mixer

Devon

Thermostatic 2-3 Way Shower Mixer - Wall Mount - 4"

Features

- Thermostatic valve.
- Brass valve body.
- Zinc alloy handles.
- Stainless steel trim plate with chrome surface.
- Designed to fit into standard 4.5" frame wall.
- Delivers a generous flow rate.
- Standard 1/2 inch inlet and outlet.
- Flow rate 3.4 GPM.
- Diverter with 2 or 3 functions configurable during the installation process.
- Sedal ceramic thermostatic cartridge.
- Integrated shut-off valves.

Material

- Premium material construction with metal handle ensures reliability and durability.
- BATHONOMY finishes resist corrosion and tarnishing.
- Brass

Dimensions

- W: 4.3" * H:7.9" * D: 4"

Weight

- 8.8 lb.



Codes/Standards





COF.SHM.DEV.04.00.BR.MBL

BATHONOMY Faucet Lifetime Limited Warranty

See website for detailed warranty information.

Available Colors/Finishes

Color tiles intended for reference only.

Color	Code	Description
	BNI	Brushed Nickel
	MBL	Matt Black
	PCH	Polished Chrome
	SBR	Satin Brass



Codes / Standards compliance: Uniform Plumbing Code (UPC)
 National Plumbing Code of Canada
 ASME A112.18.1-2018 / CSA B125.1-18 / ASSE 1016
 IAPMO file number: 8659 (for more info visit: <http://pld.iapmo.org/default.aspx>)
 SKU for iapmo search LTA1010



bathonomy ShowerMixer

Devon

Thermostatic 2-3 Way Shower Mixer - Wall Mount - 4"

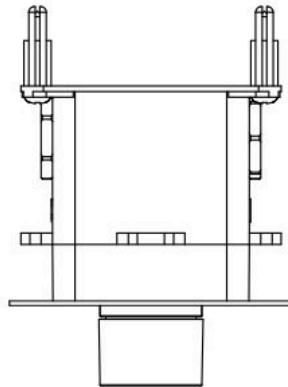
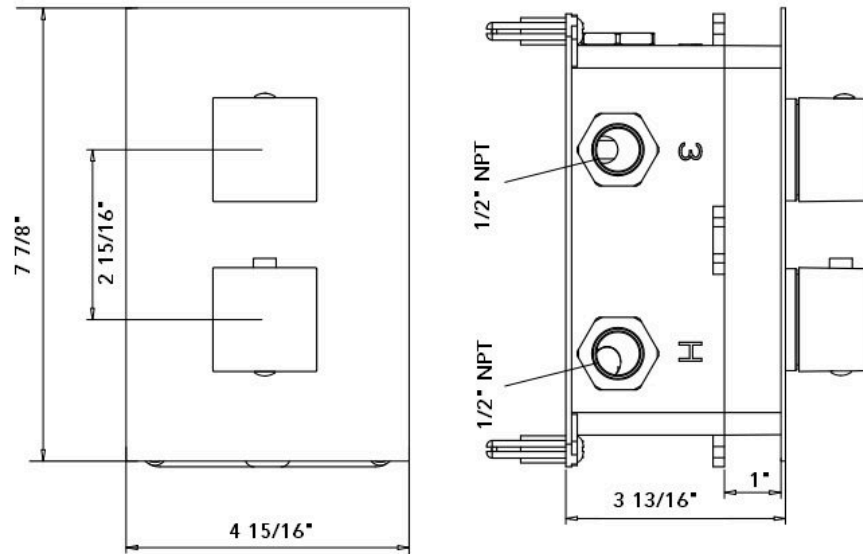

Technical Information

All product dimensions are nominal.

Shower head included: No

Shower arm: No

Notes

Install the product according to the installation guide.