

Features

- Low profile door design
- Ideal for remodeling with a 1" (25 mm) flange
- Clean interior due to hidden shelf adjustments that move at 1/2" (13 mm) increments
- Mirrored interior
- Includes installation hardware for recess mounting
- Can be recessed or surface mounted (surface mounting kit required)
- Slow-close functionality
- Can be installed with left or right opening

Construction

- Satin anodized aluminum body
- 3 mirror design - rear of cabinet and both sides of door
- Grass 108° self-closing hinges with 3 way adjustability
- Safeseal® Gasket with sealed corners on cabinet body

Dimensions

Height: 36-1/8" (918 mm)
 Width: 24" (610 mm)
 Depth: 5-1/16" (129 mm) When surface mounted
 1-1/16" (27 mm) When recessed

Options

- Polished edge or beveled front mirror
- Other widths and heights available

Installation Options

Recessed Mount - Rough Opening - 34" H x 22" W x 4" D (864 mm H x 559 mm W x 102 mm D)
Surface Mount - Reference Surface Mount Kit when ordering RSMK36D4P - Polished Edge Mirror Side Kit

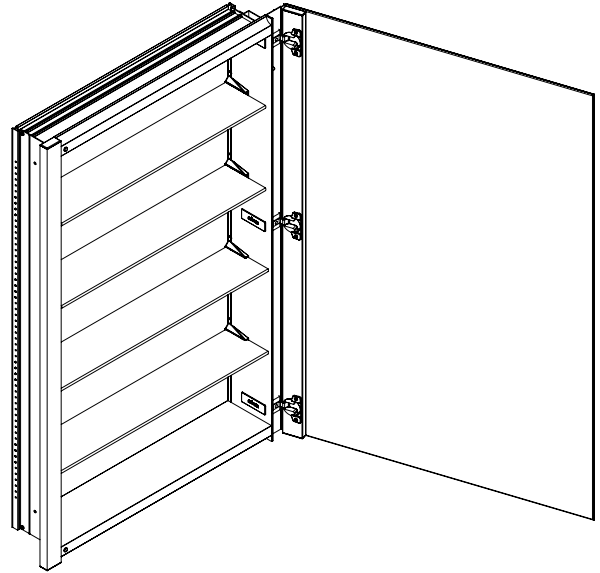

Model Number Key

Series	Cabinet	Width	Height	Depth	Mirror Edge	Number of Doors
R	C	24"	36"	D4	FP = Flat, Polished FB = Flat, Beveled	1

