

Features

- 36" minimum base cabinet width
- Single bowl
- 9-1/2" (241 mm) depth provides generous workspace
- Offset drain increases workspace in the sink and storage space underneath
- Includes K-5196 sink rack
- Includes cutout templates and installation clips
- Matte finish offers rich, dimensional color

Material

- KOHLER Neoroc® composite is durable and built to withstand day-to-day cleaning tasks
- Solid color throughout the sink
- Heat-resistant up to 750°F
- Scratch-, stain-, chip-, and thermal-shock-resistant

Installation

- Undermount
- Easy to install in a one-person, single-day project

Required Products/Accessories

K-5192 Small stainless steel sink rack for K-8206

or

K-11352 Disposal Flange with Stopper

or

K-8801 Sink drain and strainer with tailpiece

or

K-8799 Sink drain and strainer basket

Recommended Products/Accessories

K-23730 Neoroc® cleaner

K-23726 Drain treatment

Optional Products/Accessories

K-9000 P-Trap

Included Components

Additional Components:

5196



Codes/Standards







CSA B45.5/IAPMO Z124

KOHLER® Neoroc® Sinks Lifetime Limited Warranty

See website for detailed warranty information.

Available Colors/Finishes

Color tiles intended for reference only.

| Color | Code | Description |
|---|------|----------------|
|  | CM6 | Matte White |
|  | CM7 | Matte Graphite |
|  | CM1 | Matte Black |
|  | CM2 | Matte Brown |
|  | CM3 | Matte Taupe |
|  | CM4 | Matte Grey |

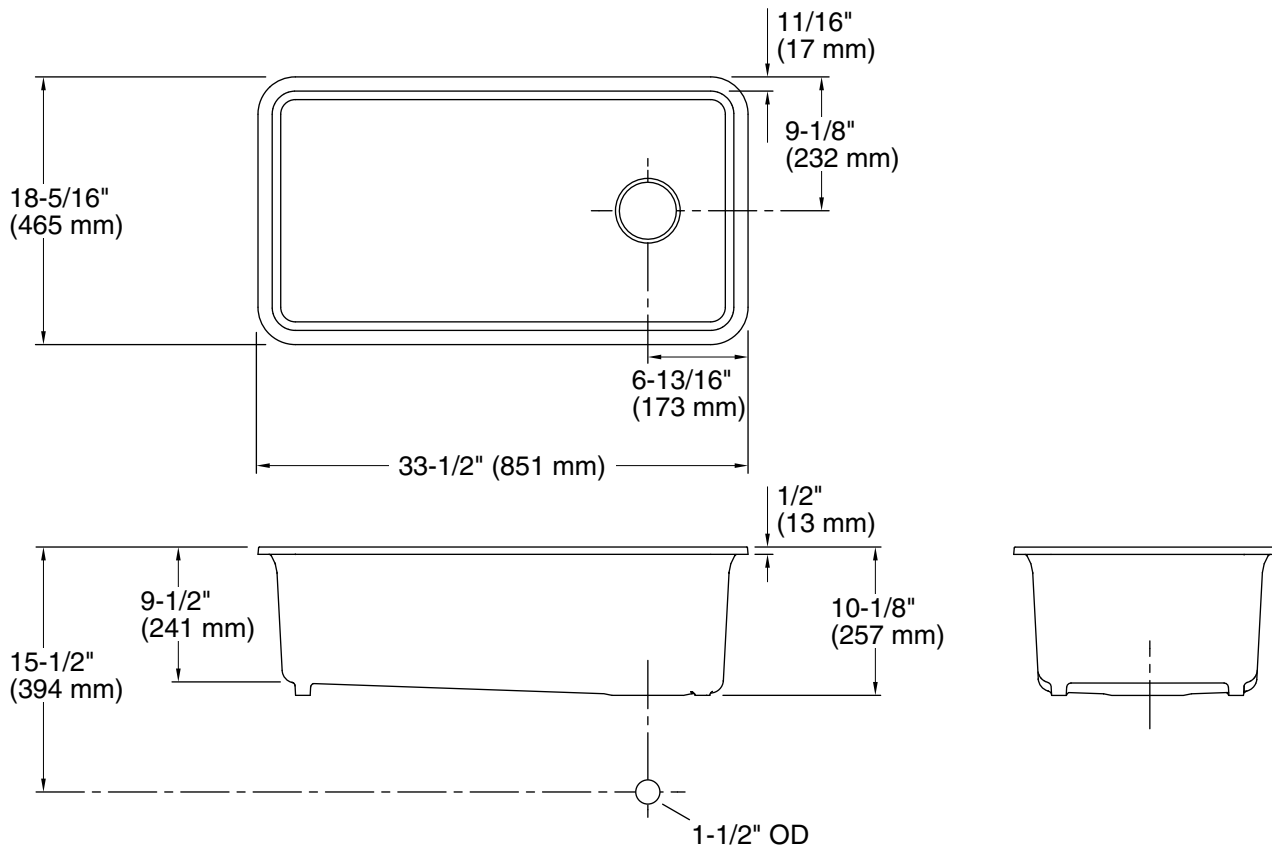

Technical Information

All product dimensions are nominal.

| | |
|--------------------------|---|
| Bowl configuration: | Single |
| Installation: | Undermount |
| Min. base cabinet width: | 36" (914 mm) |
| Bowl area (Only): | Length: 30-9/16" (777 mm) Width: 15-3/8" (391 mm) Bowl depth: 9-1/2" (241 mm) Water depth: 9-1/2" (241 mm) |
| Drain hole: | 3-7/8" (98 mm) |
| Template: | 1256394-7, required, included |

Notes

Install this product according to the installation instructions.

Allow a minimum of 2" (51 mm) clearance around the sink rim for clip attachment.