

min 61

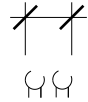

Ø25

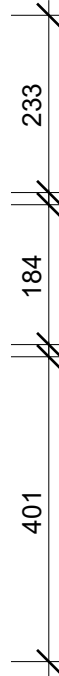
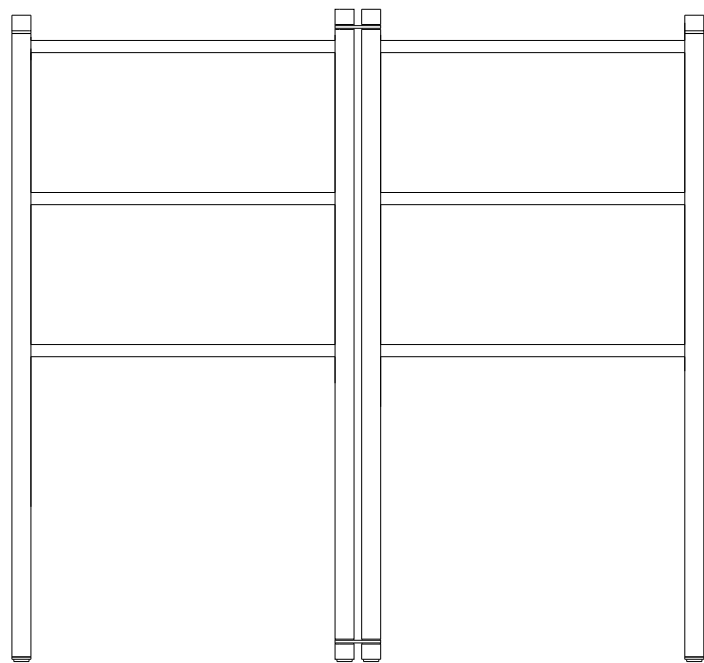
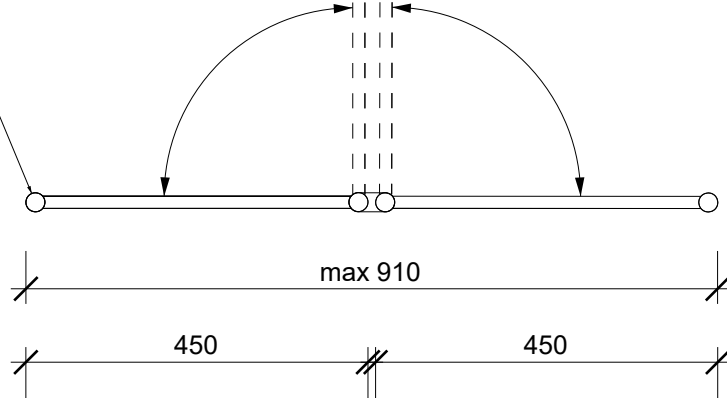

Frontansicht
front view

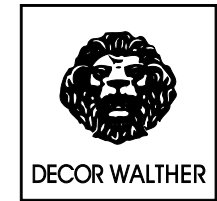
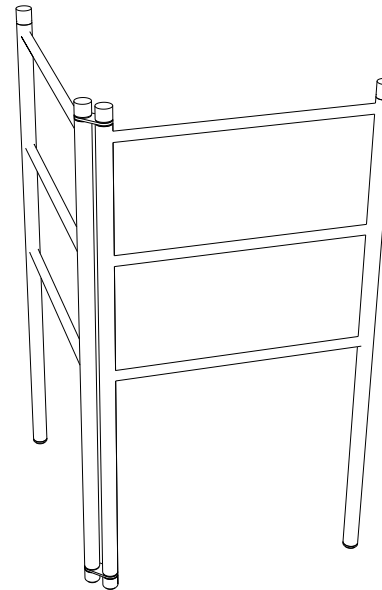

HT 15

Handtuchhalter
Towel holder

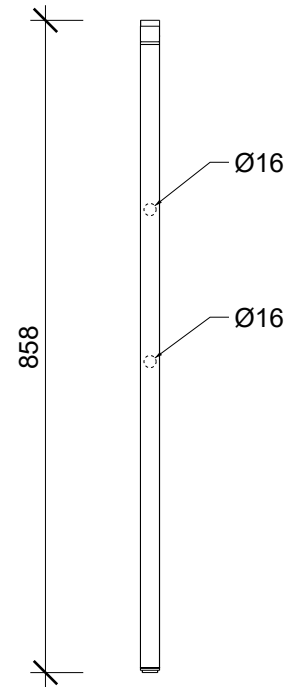

Seitenansicht
side view

Alle Angaben sind ohne Gewähr.
Maß und Modelländerungen
vorbehalten.
All information without
engagement. Measurement
and changes conditionally.