



# bathonomy Shower Arm

**Metro**

Shower Arm Ceiling Mount - 8"

## Features

Modern shower arm of our Metro family, a family of components for your shower with a round and modern design that will delight your daily shower. This family covers everything you need to build your bathroom area: mixers, heads, hand showers, connectors, tub spout, etc. Available in different finishes and functions.

- Shower arm.
- NPT 1/2 in. inlet
- G 1/2 in. outlet
- Rustproof: Yes



## Material

- Premium material construction with metal handle ensures reliability and durability.
- BATHONOMY finishes resist corrosion and tarnishing.
- Brass construction

## Dimensions

- H: 8.25" \* / Ø: 0.93"

## Weight

- 0.8 lb.

## Codes/Standards



COF.SHA.MTO.08.00.BR.PCH

## BATHONOMY Faucet Lifetime Limited Warranty

See website for detailed warranty information.

## Available Colors/Finishes

*Color tiles intended for reference only.*

Color	Code	Description
	BNI	Brushed Nickel
	MBL	Matt Black
	PCH	Polished Chrome
	SBR	Satin Brass



**Codes / Standards compliance:** Uniform Plumbing Code (UPC)  
 National Plumbing Code of Canada  
 ASME A112.18.1-2018 / CSA B125.1-18 / ASSE 1016  
 IAPMO file number: 8659 (for more info visit: <http://pld.iapmo.org/default.aspx>)  
 SKU for iapmo search LTA1010

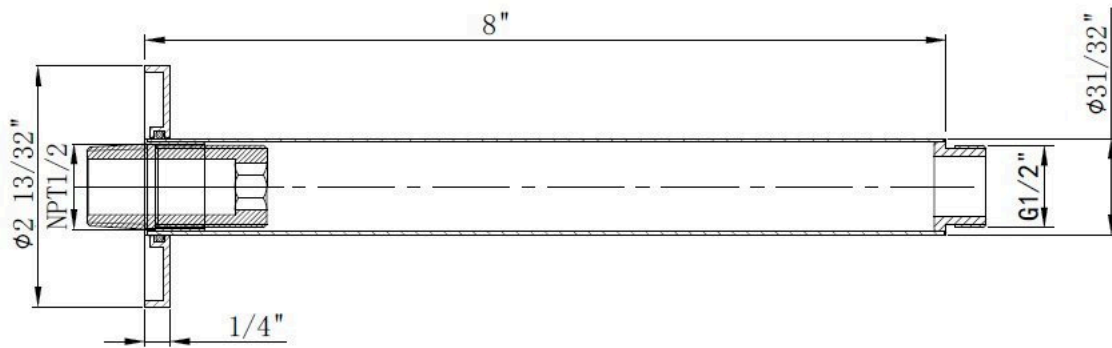

#### Technical Information

All product dimensions are nominal.

#### Notes

Install the product according to the installation guide.



# bathonomy ShowerHead

## Metro

Sharp Nozzles Shower Head Wall  
Or Ceiling Mount - 12"

### Features

Modern shower head of our Metro family, a family of components for your shower with a round and modern design that will delight your daily shower. This family covers everything you need to build your bathroom area: mixers, heads, hand showers, connectors, tub spout, etc. Available in different finishes and sizes.

- Shower head
- Thin design (5mm / 0.2 in.)
- G 1/2 in. inlet
- Silicone sharp nozzles easy to clean
- 1.8 Gpm
- Rustproof: Yes

### Material

- Premium material construction with metal handle ensures reliability and durability.
- BATHONOMY finishes resist corrosion and tarnishing.
- Stainless steel construction

### Dimensions

- H: 0.2" \* / Ø: 12"

### Weight

- 3.9 lb.

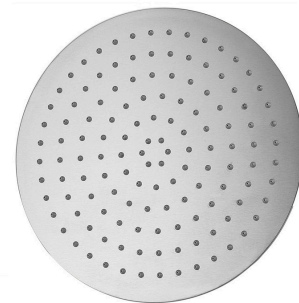

### Codes/Standards

COF.SHH.MTO.12.00.SS.BSS

### BATHONOMY Faucet Lifetime Limited Warranty

See website for detailed warranty information.

### Available Colors/Finishes

*Color tiles intended for reference only.*

#### Color Code Description

	BSS	Brushed Stainless Steel
	MBL	Matt Black
	PSS	Polished Stainless Steel
	SBR	Satin Brass



**Codes / Standards compliance:** Uniform Plumbing Code (UPC)

National Plumbing Code of Canada

ASME A112.18.1-2018 / CSA B125.1-18 / ASSE 1016

IAPMO file number: 8659 (for more info visit: <http://pld.iapmo.org/default.aspx>)

SKU for iapmo search LTA1010



# bathonomy ShowerHead

**Metro**

Sharp Nozzles Shower Head Wall  
Or Ceiling Mount - 12"

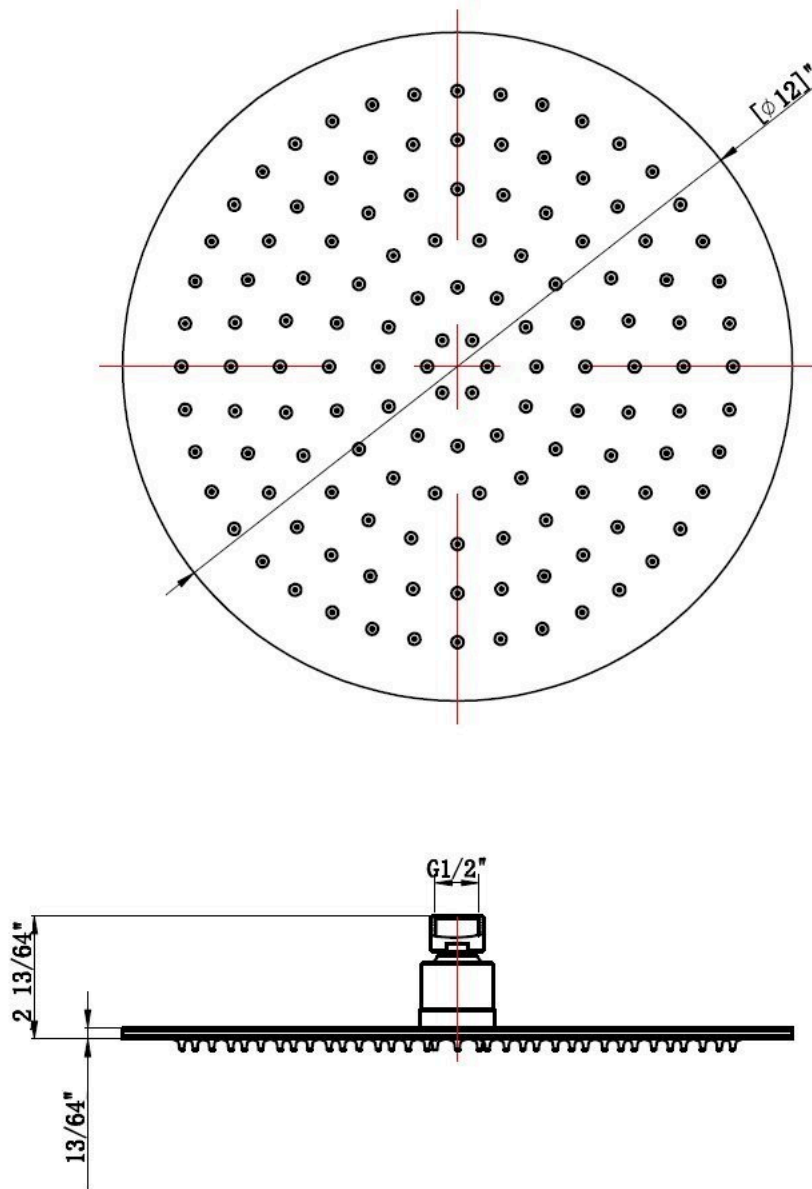

### Technical Information

All product dimensions are nominal.

### Notes

Install the product according to the installation guide.



# bathonomy Shower Mixer

**Metro**

Thermostatic 2-3 Way Shower Mixer - Wall Mount - 4"

## Features

- Thermostatic valve.
- Brass valve body.
- Zinc alloy handles.
- Stainless steel trim plate with chrome surface.
- Designed to fit into standard 4.5" frame wall.
- Delivers a generous flow rate.
- Standard 1/2 inch inlet and outlet.
- Flow rate 3.4 GPM.
- Diverter with 2 or 3 functions configurable during the installation process.
- Sedal ceramic thermostatic cartridge.
- Integrated shut-off valves.

## Material

- Premium material construction with metal handle ensures reliability and durability.
- BATHONOMY finishes resist corrosion and tarnishing.
- Brass

## Dimensions

- W: 4.3" \* H:7.9" \* D: 4"

## Weight

- 8.8 lb.



## Codes/Standards





COF.SHM.MTO.04.00.BR.PCH

## BATHONOMY Faucet Lifetime Limited Warranty

See website for detailed warranty information.

## Available Colors/Finishes

*Color tiles intended for reference only.*

Color	Code	Description
	BNI	Brushed Nickel
	MBL	Matt Black
	PCH	Polished Chrome
	SBR	Satin Brass



**Codes / Standards compliance:** Uniform Plumbing Code (UPC)  
 National Plumbing Code of Canada  
 ASME A112.18.1-2018 / CSA B125.1-18 / ASSE 1016  
 IAPMO file number: 8659 (for more info visit: <http://pld.iapmo.org/default.aspx>)  
 SKU for iapmo search LTA1010



# bathonomy ShowerMixer

**Metro**

Thermostatic 2-3 Way Shower Mixer - Wall Mount - 4"

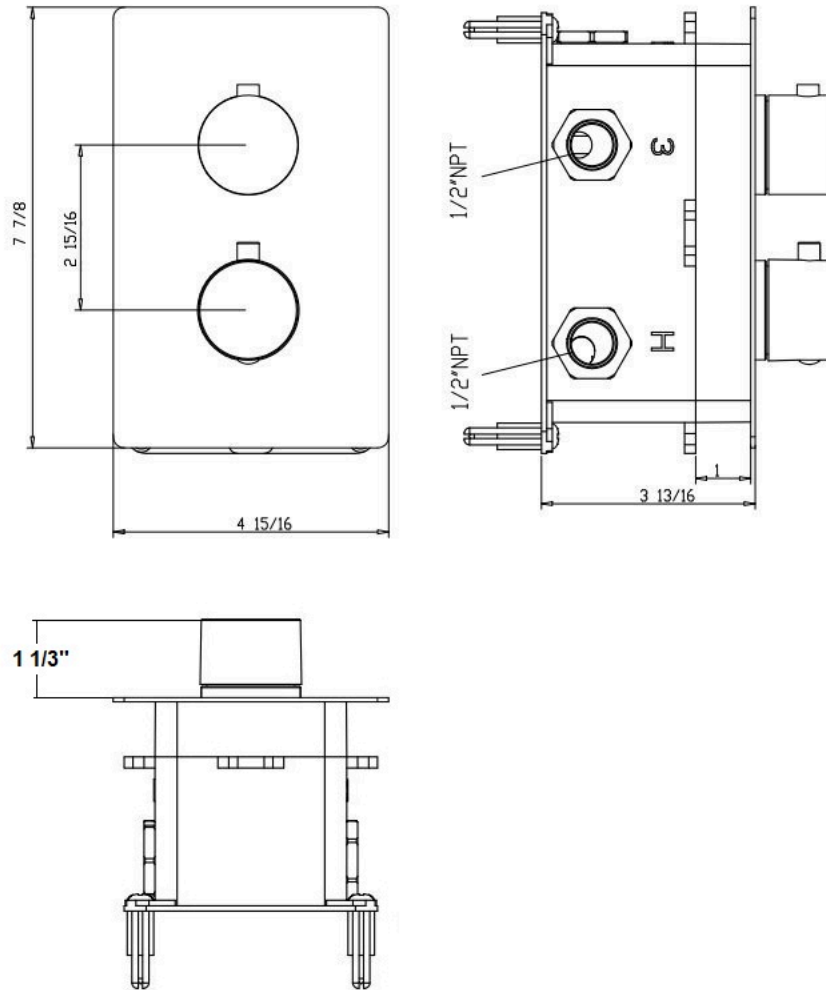

## Technical Information

All product dimensions are nominal.

Shower head included: No

Shower arm: No

## Notes

Install the product according to the installation guide.



# bathonomyHandShowerConnetor

**Metro**

Hand Shower Holder  
Connetor Wall Mount - 3"

## Features

Modern hand shower hose holder with connector of our Metro family, a family of components for your shower with a round and modern design that will delight your daily shower. This family covers everything you need to build your bathroom area: mixers, heads, hand showers, connectors, tub spout, etc. Available in different finishes and functions.

- Hose connector with holder
- Adjustable scutcheon
- NPT 1/2 in. inlet
- G 1/2 in. outlet



## Material

- Premium material construction with metal handle ensures reliability and durability.
- BATHONOMY finishes resist corrosion and tarnishing.
- Brass construction

## Dimensions

- W: 2.87" \* H: 2.37" \* D: 3.12" / Ø: 1.25"

## Weight

- 1.0 lb.

## Codes/Standards

COF.HHC.MTO.03.00.BR.PCH

## BATHONOMY Faucet Lifetime Limited Warranty

See website for detailed warranty information.

## Available Colors/Finishes

*Color tiles intended for reference only.*

Color	Code	Description
	BNI	Brushed Nickel
	MBL	Matt Black
	PCH	Polished Chrome
	SBR	Satin Brass



**Codes / Standards compliance:** Uniform Plumbing Code (UPC)  
National Plumbing Code of Canada  
ASME A112.18.1-2018 / CSA B125.1-18 / ASSE 1016  
IAPMO file number: 8659 (for more info visit: <http://pld.iapmo.org/default.aspx>)  
SKU for iapmo search LTA1010



# bathonomyHandShowerConnector

**Metro**

Hand Shower Holder  
Connector Wall Mount - 3"

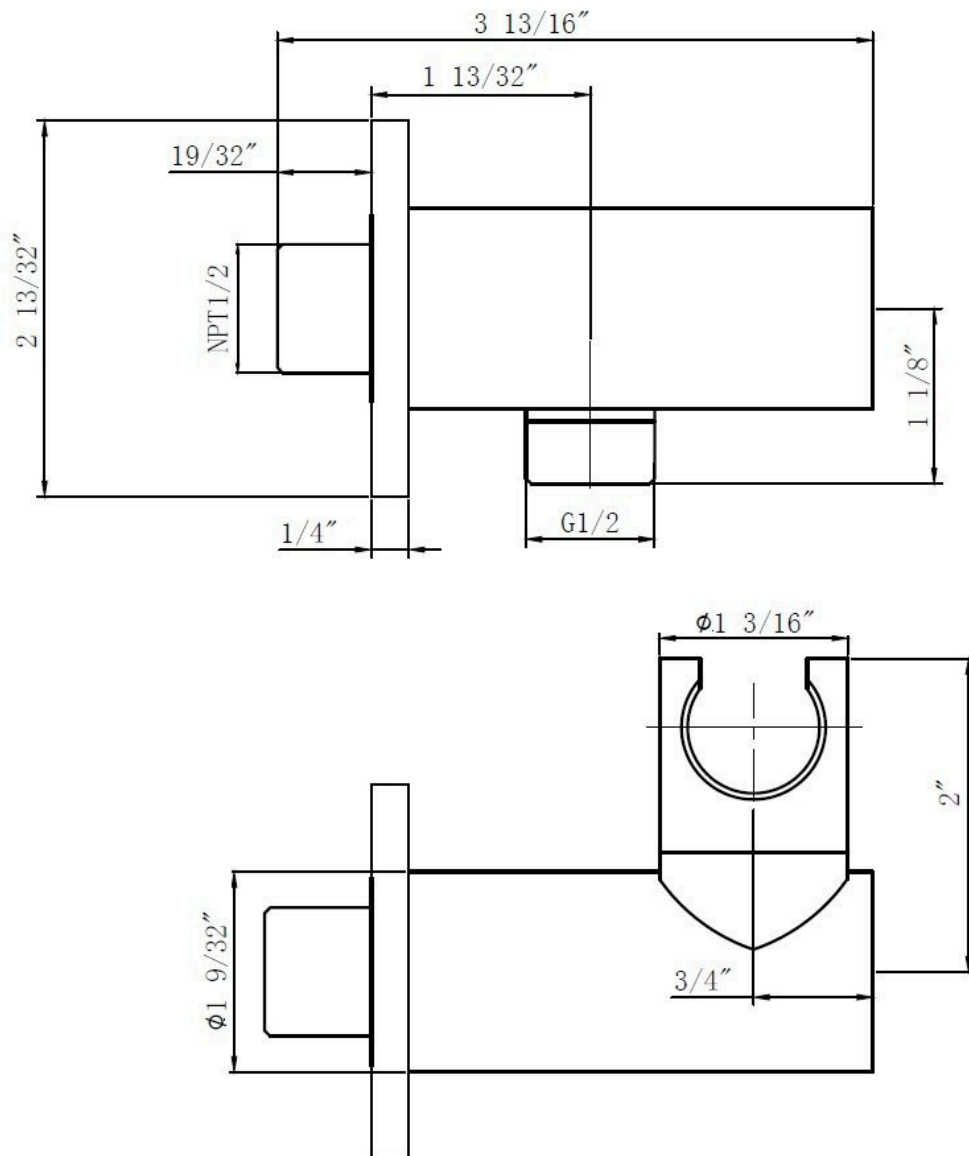

## Technical Information

All product dimensions are nominal.

## Notes

Install the product according to the installation guide.





# bathonomyHandShower

## Metro

Hand Shower  
Wall Mount - 1"

### Features

Modern hand shower of our Metro family, a family of components for your shower with a round and modern design that will delight your daily shower . This family covers everything you need to build your bathroom area : mixers , heads , tubes , connectors , tub spout , etc. Available in different finishes and function.

- Hand shower
- Only rain function
- 1.8 Gpm.
- G 1/2" inlet

### Material

- Premium material construction with metal handle ensures reliability and durability.
- BATHONOMY finishes resist corrosion and tarnishing.
- Brass construction
- Silicone sharp nozzle easy to clean.
- With back flow prevention check valve

### Dimensions

- H: 9" \* / Ø: 0.93"

### Weight

- 0.6 lb.



### Codes/Standards



COF.HSH.MTO.01.00.BR.PCH

### BATHONOMY Faucet Lifetime Limited Warranty

See website for detailed warranty information.

### Available Colors/Finishes

*Color tiles intended for reference only.*

Color	Code	Description
	BNI	Brushed Nickel
	MBL	Matt Black
	PCH	Polished Chrome
	SBR	Satin Brass



**Codes / Standards compliance:** Uniform Plumbing Code (UPC)  
 National Plumbing Code of Canada  
 ASME A112.18.1-2018 / CSA B125.1-18 / ASSE 1016  
 IAPMO file number: 8659 (for more info visit: <http://pld.iapmo.org/default.aspx>)  
 SKU for iapmo search LTA1010



# bathonomy HandShower

**Metro**

Hand Shower  
Wall Mount - 1"

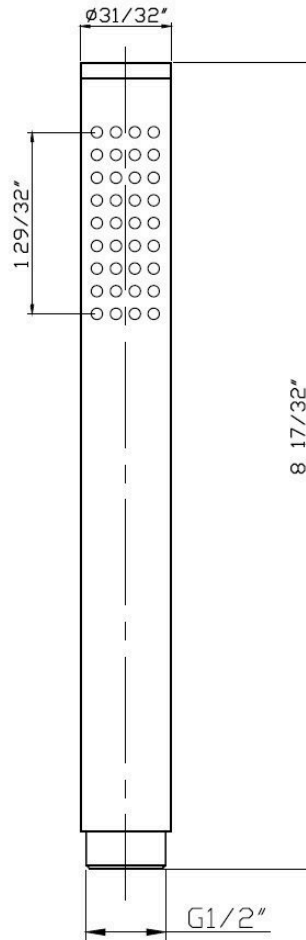

## Technical Information

All product dimensions are nominal.

## Notes

Install the product according to the installation guide.