



# bathonomy Shower Arm

## Luk2

Shower Arm Wall Mount - 16"

### Features

Elegant and modern shower arm from our Luk 2 family. With a flat design it is specially designed for large showers. The shield is attached to the tube that makes it more elegant.

- Shower arm.
- NPT 1/2 in. inlet
- G 1/2 in. outlet
- Rustproof: Yes



### Material

- Premium material construction with metal handle ensures reliability and durability.
- BATHONOMY finishes resist corrosion and tarnishing.
- Brass construction

### Dimensions

- W: 16" \* H: 1.25" \* D: 1.25"

### Weight

- 1 lb.

### Codes/Standards

COF.SHA.DEV.15.75.BR.BNI

### BATHONOMY Faucet Lifetime Limited Warranty

See website for detailed warranty information.

### Available Colors/Finishes

*Color tiles intended for reference only.*

Color	Code	Description
	BNI	Brushed Nickel
	MBL	Matt Black
	PCH	Polished Chrome
	SBR	Satin Brass



**Codes / Standards compliance:** Uniform Plumbing Code (UPC)  
 National Plumbing Code of Canada  
 ASME A112.18.1-2018 / CSA B125.1-18 / ASSE 1016  
 IAPMO file number: 8659 (for more info visit: <http://pld.iapmo.org/default.aspx>)  
 SKU for iapmo search LTA1010



# bathonomy ShowerArm

**Luk2**

Shower Arm Wall  
Mount - 16"

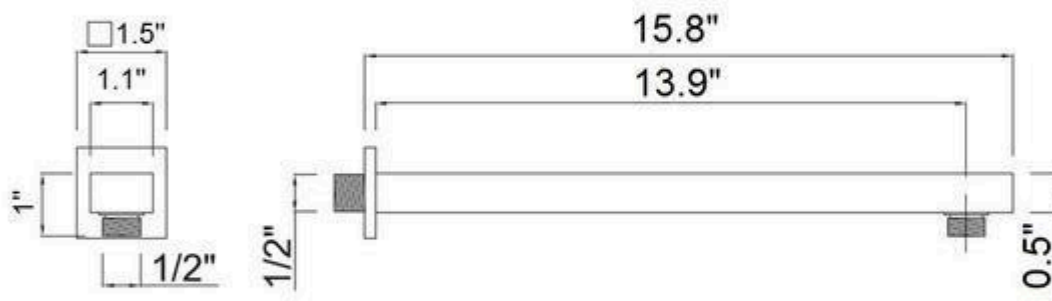

### Technical Information

All product dimensions are nominal.

### Notes

Install the product according to the installation guide.



# bathonomy ShowerHead

## Devon

Sharp Nozzles Shower Head Wall  
Or Ceiling Mount - 8"

### Features

Modern shower head of our Devon family, a family of components for your shower with a square and modern design that will delight your daily shower. This family covers everything you need to build your bathroom area: mixers, heads, hand showers, connectors, tub spout, etc. Available in different finishes and sizes.

- Shower head
- Thin design (5mm / 0.2 in.)
- G 1/2 in. inlet
- Silicone sharp nozzles easy to clean
- 1.8 Gpm
- Rustproof: Yes

### Material

- Premium material construction with metal handle ensures reliability and durability.
- BATHONOMY finishes resist corrosion and tarnishing.
- Stainless steel construction

### Dimensions

- W: 8" \* H: 0.2" \* D: 8"

### Weight

- 2.4 lb.

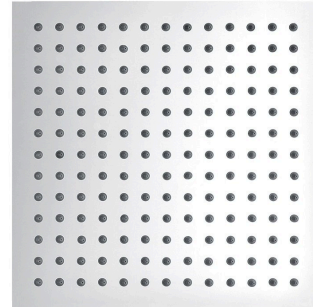

### Codes/Standards

COF.SHH.DEV.08.00.SS.BSS

### BATHONOMY Faucet Lifetime Limited Warranty

See website for detailed warranty information.

### Available Colors/Finishes

*Color tiles intended for reference only.*

#### Color Code Description

Color	Code	Description
	BSS	Brushed Stainless Steel
	MBL	Matt Black
	PSS	Polished Stainless Steel
	SBR	Satin Brass



**Codes / Standards compliance:** Uniform Plumbing Code (UPC)

National Plumbing Code of Canada

ASME A112.18.1-2018 / CSA B125.1-18 / ASSE 1016

IAPMO file number: 8659 (for more info visit: <http://pld.iapmo.org/default.aspx>)

SKU for iapmo search LTA1010



# bathonomy ShowerHead

**Devon**

Sharp Nozzles Shower Hea Wall  
Or Ceiling Mount - 8"

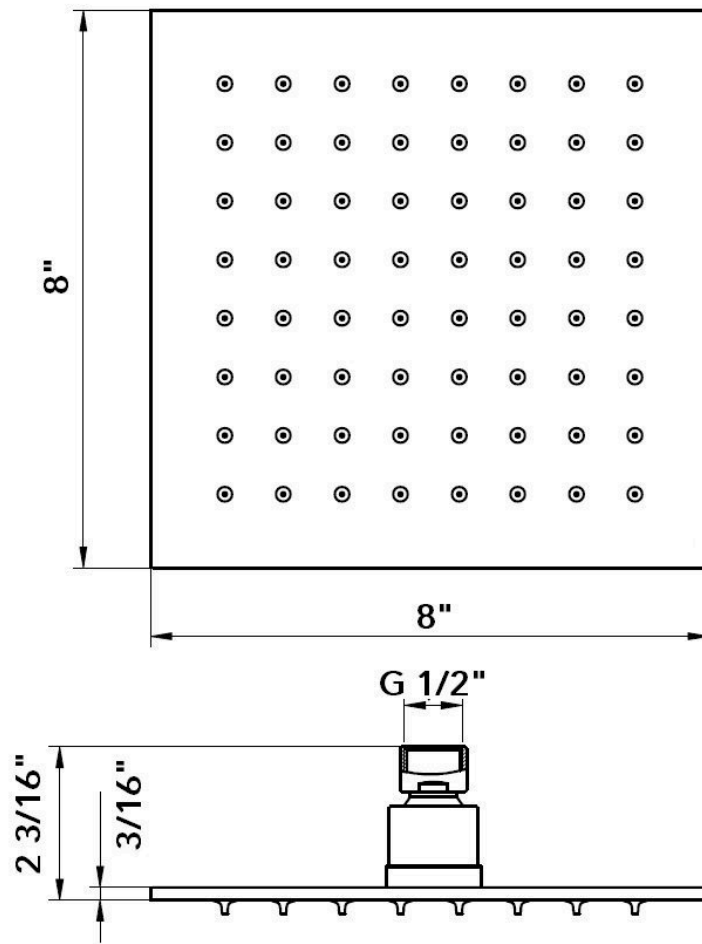

### Technical Information

All product dimensions are nominal.

### Notes

Install the product according to the installation guide.



# bathonomyHandShowerConnector

**Devon**

Hand Shower Holder  
Connector Wall Mount - 3"

## Features

Modern hand shower hose holder with connector of our Devon family, a family of components for your shower with a square and modern design that will delight your daily shower. This family covers everything you need to build your bathroom area: mixers, heads, hand showers, connectors, tub spout, etc. Available in different finishes and functions.

- Hose connector with holder
- Adjustable scutcheon
- NPT 1/2 in. inlet
- G 1/2 in. outlet



## Material

- Premium material construction with metal handle ensures reliability and durability.
- BATHONOMY finishes resist corrosion and tarnishing.
- Brass construction

## Dimensions

- W: 3" \* H: 2.36" \* D: 3.25"

## Weight

- 1.7 lb.

## Codes/Standards

COF.HHC.DEV.03.00.BR.PCH





## BATHONOMY Faucet Lifetime Limited Warranty

See website for detailed warranty information.

## Available Colors/Finishes

*Color tiles intended for reference only.*

### Color Code Description

	BNI	Brushed Nickel
	MBL	Matt Black
	PCH	Polished Chrome
	SBR	Satin Brass



**Codes / Standards compliance:** Uniform Plumbing Code (UPC)

National Plumbing Code of Canada

ASME A112.18.1-2018 / CSA B125.1-18 / ASSE 1016

IAPMO file number: 8659 (for more info visit: <http://pld.iapmo.org/default.aspx>)

SKU for iapmo search LTA1010



# bathonomyHandShowerConnector

Devon

Hand Shower Holder  
Connector Wall Mount - 3"

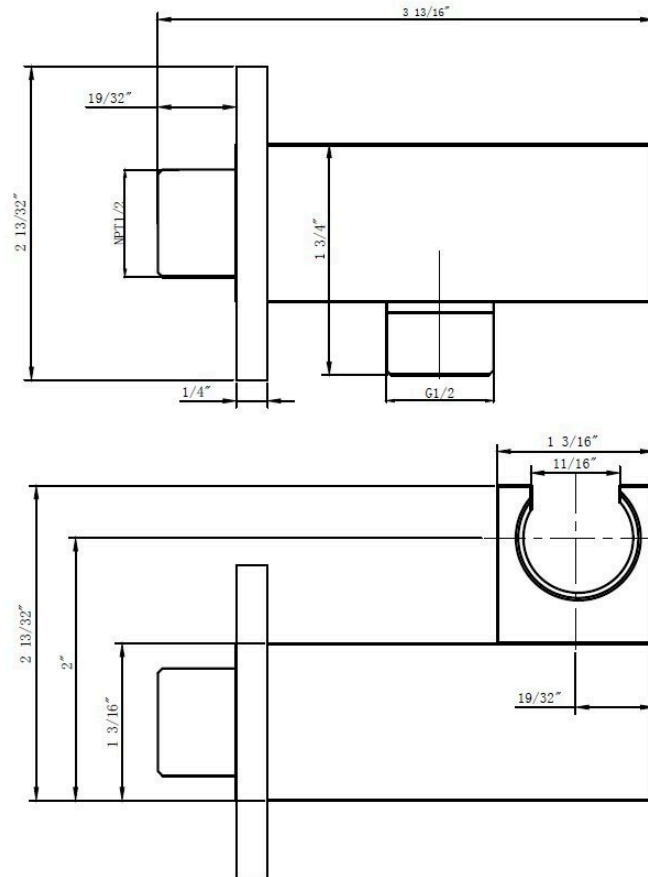

## Technical Information

All product dimensions are nominal.

## Notes

Install the product according to the installation guide.



# bathonomy ShowerHose

## ShowerComplements

Hand Shower Hose  
Wall Mount - 5"

### Features

Traditional and modern hand shower hose of our Shower Complements family, a family of components where you will find what you need to complete the installation of your shower. Available in different finishes.

- Hand shower hose
- 60 in. length
- Round connector on each end.
- Rubber washer on the bracket connector to prevent slipping.
- NPT 1/2 in. inlet and outlet connections.

### Material

- Premium material construction with metal handle ensures reliability and durability.
- BATHONOMY finishes resist corrosion and tarnishing.
- Stainless steel construction

### Dimensions

- W: 120" \* / Ø: 0.5"

### Weight

- 0.3 lb.



### Codes/Standards





COF.HHO.SCO.05.00.SS.PCH

### **BATHONOMY Faucet Lifetime Limited Warranty**

See website for detailed warranty information.

### Available Colors/Finishes

*Color tiles intended for reference only.*

Color	Code	Description
	BNI	Brushed Nickel
	MBL	Matt Black
	PCH	Polished Chrome
	SBR	Satin Br



**Codes / Standards compliance:** Uniform Plumbing Code (UPC)  
 National Plumbing Code of Canada  
 ASME A112.18.1-2018 / CSA B125.1-18 / ASSE 1016  
 IAPMO file number: 8659 (for more info visit: <http://pld.iapmo.org/default.aspx>)  
 SKU for iapmo search LTA1010



# bathonomy HandShower

## Cubic

Hand Shower - Wall Mount - 8"

### Features

Elegant hand shower of our family Cubic. Manufactured in brass with interior in plastic will make this hand shower stand the test of time as the first day. Water outlets directly manufactured in the interior plastic easy to clean. Complete this article with our bars, tubes, connectors and mixers from the Luk 2 or Cubic family.

- Made in brass with interior in plastic
- 1/2 inch male connection.
- With back flow prevention check valve

### Material

- Premium material construction with metal handle ensures reliability and durability.
- BATHONOMY finishes resist corrosion and tarnishing.
- Brass construction

### Dimensions

- W: 8" \* H: 1" \* D: 1"

### Weight

- 0.5 lb.



### Codes/Standards

CAN.HSH.CUB.08.00.BR.PCH

### BATHONOMY Faucet Lifetime Limited Warranty

See website for detailed warranty information.

### Available Colors/Finishes

*Color tiles intended for reference only.*

#### Color Code Description

Color	Code	Description
	BSS	Brushed Stainless Steel
	MBL	Matt Black
	PSS	Polished Stainless Steel
	SBR	Satin Brass



**Codes / Standards compliance:** Uniform Plumbing Code (UPC)

National Plumbing Code of Canada

ASME A112.18.1-2018 / CSA B125.1-18 / ASSE 1016

IAPMO file number: 8659 (for more info visit: <http://pld.iapmo.org/default.aspx>)

SKU for iapmo search LTA1010



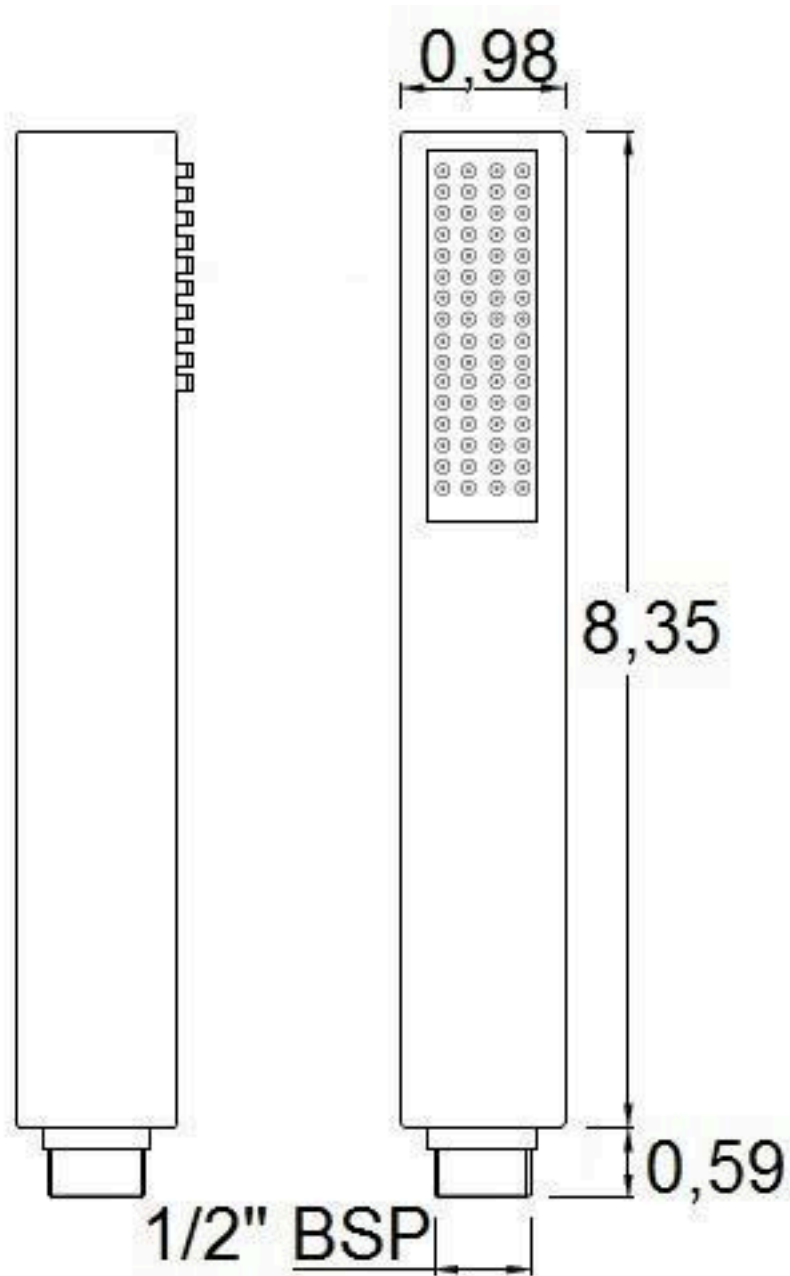

**Technical Information**

All product dimensions are nominal.

**Notes**

Install the product according to the installation guide.



# bathonomy Shower Mixer

**Devon**

Thermostatic 2-3 Way Shower Mixer - Wall Mount - 4"

## Features

- Thermostatic valve.
- Brass valve body.
- Zinc alloy handles.
- Stainless steel trim plate with chrome surface.
- Designed to fit into standard 4.5" frame wall.
- Delivers a generous flow rate.
- Standard 1/2 inch inlet and outlet.
- Flow rate 3.4 GPM.
- Diverter with 2 or 3 functions configurable during the installation process.
- Sedal ceramic thermostatic cartridge.
- Integrated shut-off valves.

## Material

- Premium material construction with metal handle ensures reliability and durability.
- BATHONOMY finishes resist corrosion and tarnishing.
- Brass

## Dimensions

- W: 4.3" \* H:7.9" \* D: 4"

## Weight

- 8.8 lb.



## Codes/Standards

COF.SHM.DEV.04.00.BR.PCH





## BATHONOMY Faucet Lifetime Limited Warranty

See website for detailed warranty information.

## Available Colors/Finishes

*Color tiles intended for reference only.*

### Color Code Description

	BNI	Brushed Nickel
	MBL	Matt Black
	PCH	Polished Chrome
	SBR	Satin Brass



**Codes / Standards compliance:** Uniform Plumbing Code (UPC)

National Plumbing Code of Canada

ASME A112.18.1-2018 / CSA B125.1-18 / ASSE 1016

IAPMO file number: 8659 (for more info visit: <http://pld.iapmo.org/default.aspx>)

SKU for iapmo search LTA1010



# bathonomy ShowerMixer

**Devon**

Thermostatic 2-3 Way Shower Mixer - Wall Mount - 4"

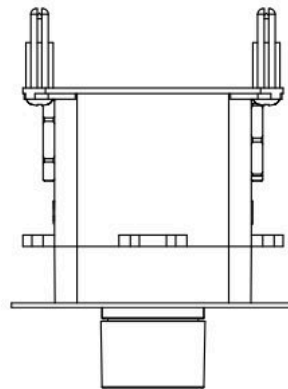
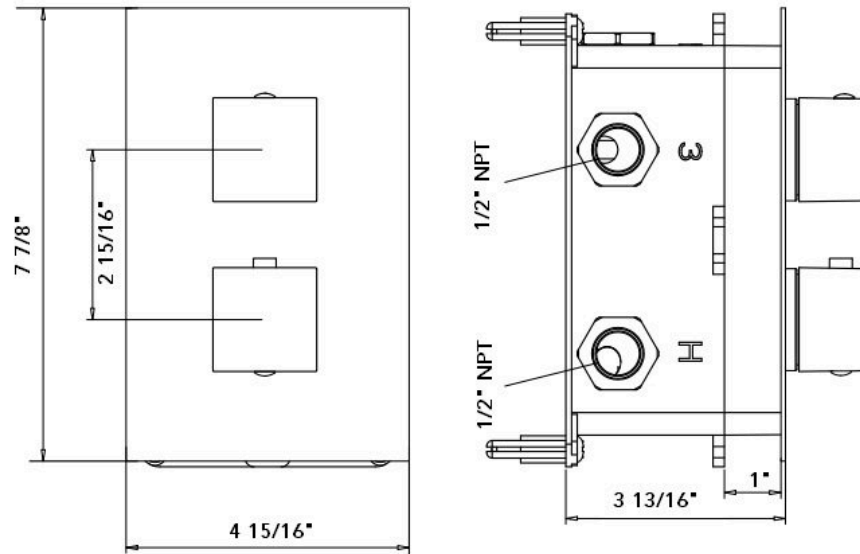

## Technical Information

All product dimensions are nominal.

Shower head included: No

Shower arm: No

## Notes

Install the product according to the installation guide.



# bathonomy TubSpout

**Devon**

Tub Spout - Wall Mount - 7"

## Features

Modern bathtub spout of our Devon family, a family of components for your shower with a square and modern design that will delight your daily shower. This family covers everything you need to build your bathroom area: mixers, heads, hand showers, connectors, tub spout, etc. Available in different finishes and functions.

- Bathtub spout
- NPT 1/2 in. inlet
- Adjustable scutcheon
- Rustproof: Yes

## Material

- Premium material construction with metal handle ensures reliability and durability.
- BATHONOMY finishes resist corrosion and tarnishing.
- Brass construction

## Dimensions

- W: 1.12" \* H: 1.12" \* D: 7.5"

## Weight

- 1.5 lb.

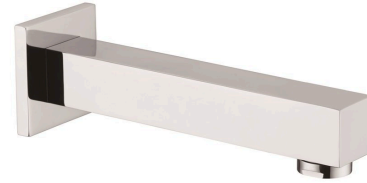

## Codes/Standards





COF.TUS.DEV.07.05.BR.PCH

## BATHONOMY Faucet Lifetime Limited Warranty

See website for detailed warranty information.

## Available Colors/Finishes

*Color tiles intended for reference only.*

Color	Code	Description
	BNI	Brushed Nickel
	MBL	Matt Black
	PCH	Polished Chrome
	SBR	Satin Brass



**Codes / Standards compliance:** Uniform Plumbing Code (UPC)  
 National Plumbing Code of Canada  
 ASME A112.18.1-2018 / CSA B125.1-18 / ASSE 1016  
 IAPMO file number: 8659 (for more info visit: <http://pld.iapmo.org/default.aspx>)  
 SKU for iapmo search LTA1010

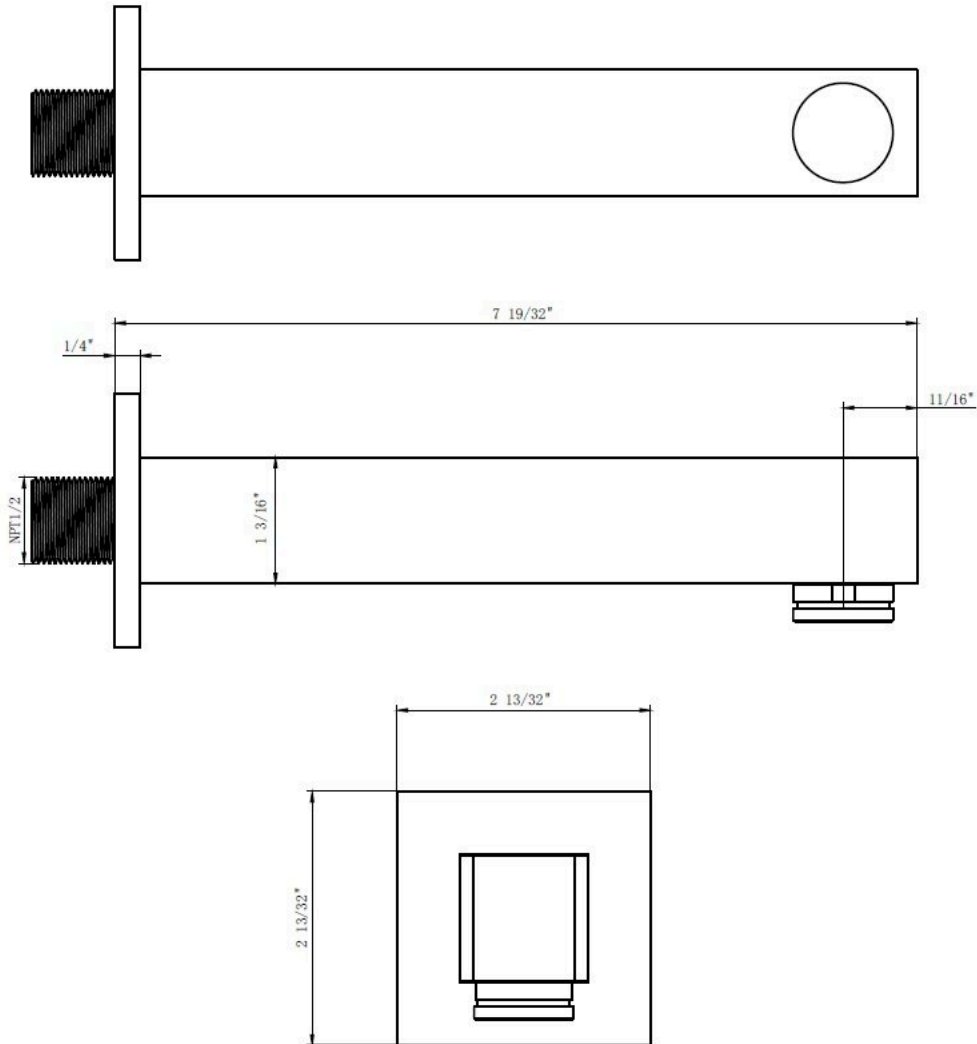

**Technical Information**

All product dimensions are nominal.

**Notes**

Install the product according to the installation guide.