



# bathonomy Shower Arm

**Devon**

Shower Arm Ceiling Mount - 8"

## Features

Modern shower arm of our Devon family, a family of components for your shower with a square and modern design that will delight your daily shower. This family covers everything you need to build your bathroom area: mixers, heads, hand showers, connectors, tub spout, etc. Available in different finishes.

- Shower arm.
- NPT 1/2 in. inlet
- G 1/2 in. outlet
- Rustproof: Yes

## Material

- Premium material construction with metal handle ensures reliability and durability.
- BATHONOMY finishes resist corrosion and tarnishing.
- Brass construction

## Dimensions

- W: 1" \* H: 5.25" \* D: 1"

## Weight

- 1.1 lb.



## Codes/Standards

COF.SHA.DEV.04.00.BR.SBR

## BATHONOMY Faucet Lifetime Limited Warranty

See website for detailed warranty information.

## Available Colors/Finishes

*Color tiles intended for reference only.*

Color	Code	Description
	BNI	Brushed Nickel
	MBL	Matt Black
	PCH	Polished Chrome
	SBR	Satin Brass



**Codes / Standards compliance:** Uniform Plumbing Code (UPC)  
 National Plumbing Code of Canada  
 ASME A112.18.1-2018 / CSA B125.1-18 / ASSE 1016  
 IAPMO file number: 8659 (for more info visit: <http://pld.iapmo.org/default.aspx>)  
 SKU for iapmo search LTA1010

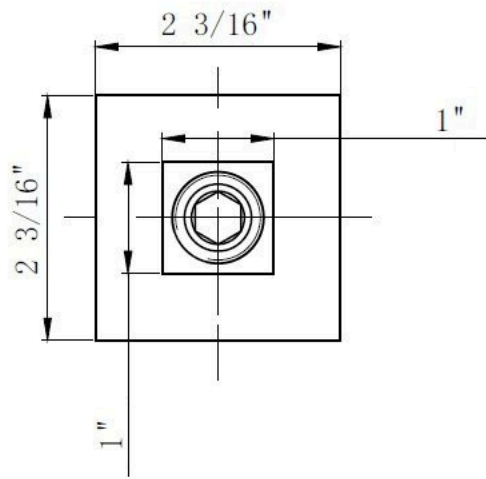
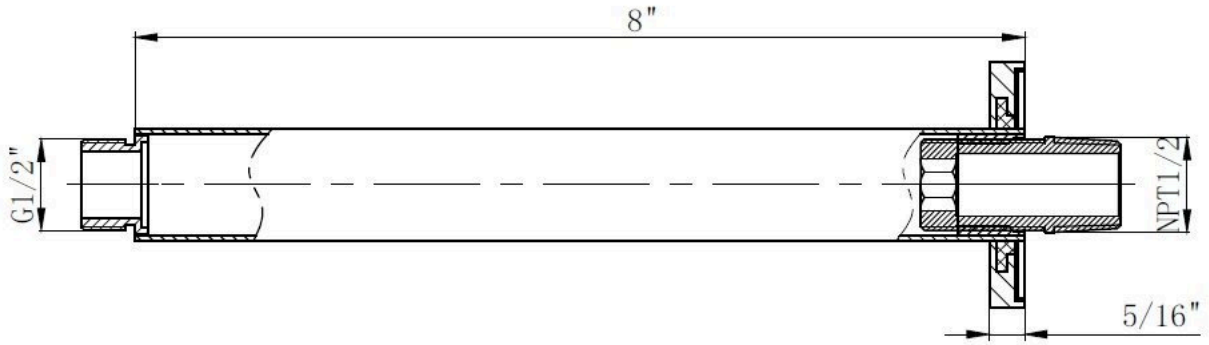

**Technical Information**

All product dimensions are nominal.

**Notes**

Install the product according to the installation guide.



# bathonomy ShowerHead

## Devon

Sharp Nozzles Shower Head Wall Or Ceiling Mount - 12"

### Features

Modern shower head of our Devon family, a family of components for your shower with a square and modern design that will delight your daily shower. This family covers everything you need to build your bathroom area: mixers, heads, hand showers, connectors, tub spout, etc. Available in different finishes and sizes.

- Shower head
- Thin design (5mm / 0.2 in.)
- G 1/2 in. inlet
- Silicone sharp nozzles easy to clean
- 1.8 Gpm
- Rustproof: Yes

### Material

- Premium material construction with metal handle ensures reliability and durability.
- BATHONOMY finishes resist corrosion and tarnishing.
- Stainless steel construction

### Dimensions

- W: 12" \* H: 0.2" \* D: 12"

### Weight

- 4.6 lb.

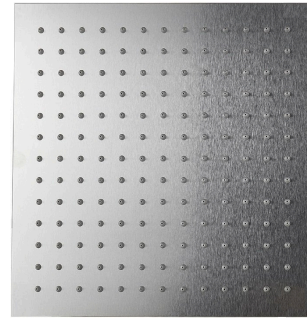

### Codes/Standards

COF.SHH.DEV.12.00.SS.BSS

### BATHONOMY Faucet Lifetime Limited Warranty

See website for detailed warranty information.

### Available Colors/Finishes

*Color tiles intended for reference only.*

#### Color Code Description

Color	Code	Description
	BSS	Brushed Stainless Steel
	MBL	Matt Black
	PSS	Polished Stainless Steel
	SBR	Satin Brass



**Codes / Standards compliance:** Uniform Plumbing Code (UPC)

National Plumbing Code of Canada

ASME A112.18.1-2018 / CSA B125.1-18 / ASSE 1016

IAPMO file number: 8659 (for more info visit: <http://pld.iapmo.org/default.aspx>)

SKU for iapmo search LTA1010



# bathonomy ShowerHead

**Devon**

Sharp Nozzles Shower Hea Wall  
Or Ceiling Mount - 12"

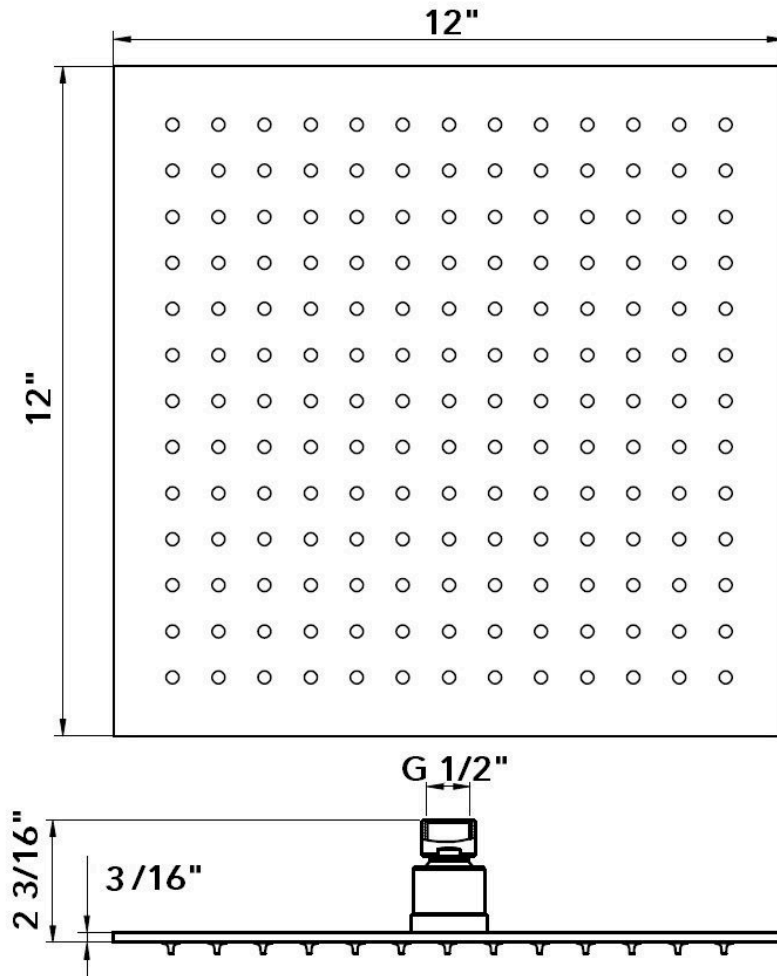

### Technical Information

All product dimensions are nominal.

### Notes

Install the product according to the installation guide.



# bathonomyHandShowerConnetor

**Devon**

Hand Shower Holder  
Connetor Wall Mount - 3"

## Features

Modern hand shower hose holder with connector of our Devon family, a family of components for your shower with a square and modern design that will delight your daily shower. This family covers everything you need to build your bathroom area: mixers, heads, hand showers, connectors, tub spout, etc. Available in different finishes and functions.

- Hose connector with holder
- Adjustable scutcheon
- NPT 1/2 in. inlet
- G 1/2 in. outlet



## Material

- Premium material construction with metal handle ensures reliability and durability.
- BATHONOMY finishes resist corrosion and tarnishing.
- Brass construction

## Dimensions

- W: 3" \* H: 2.36" \* D: 3.25"

## Weight

- 1.7 lb.

## Codes/Standards

COF.HHC.DEV.03.00.BR.BNI





## BATHONOMY Faucet Lifetime Limited Warranty

See website for detailed warranty information.

## Available Colors/Finishes

*Color tiles intended for reference only.*

### Color Code Description

	BNI	Brushed Nickel
	MBL	Matt Black
	PCH	Polished Chrome
	SBR	Satin Brass



**Codes / Standards compliance:** Uniform Plumbing Code (UPC)

National Plumbing Code of Canada

ASME A112.18.1-2018 / CSA B125.1-18 / ASSE 1016

IAPMO file number: 8659 (for more info visit: <http://pld.iapmo.org/default.aspx>)

SKU for iapmo search LTA1010



# bathonomyHandShowerConnector

Devon

Hand Shower Holder  
Connector Wall Mount - 3"

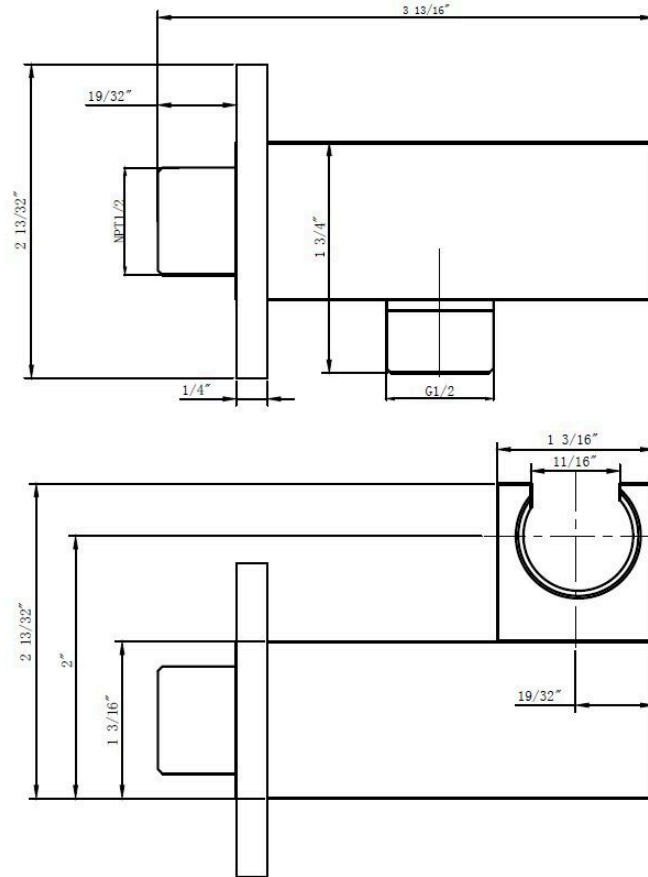

## Technical Information

All product dimensions are nominal.

## Notes

Install the product according to the installation guide.



# bathonomyHandShower

**Devon**

Hand Shower  
Wall Mount - 1"

## Features

Modern hand shower of our Devon family, a family of components for your shower with a square and modern design that will delight your daily shower. This family covers everything you need to build your bathroom area: mixers, heads, tubes, connectors, tub spout, etc. Available in different finishes and functions.

- Hand shower
- Only rain function
- 1.8 Gpm.
- G 1/2" inlet
- With back flow prevention check valve

## Material

- Premium material construction with metal handle ensures reliability and durability.
- BATHONOMY finishes resist corrosion and tarnishing.
- Brass construction
- Silicone sharp nozzle easy to clean.

## Dimensions

**Weight:** 1.12" \* H: 8.25" \* D: 1.12"

- 0.3 lb.



## Codes/Standards

COF.HSH.DEV.01.00.AB.BNI

## BATHONOMY Faucet Lifetime Limited Warranty

See website for detailed warranty information.

## Available Colors/Finishes

*Color tiles intended for reference only.*

Color	Code	Description
	BNI	Brushed Nickel
	MBL	Matt Black
	PCH	Polished Chrome
	SBR	Satin Brass



**Codes / Standards compliance:** Uniform Plumbing Code (UPC)  
 National Plumbing Code of Canada  
 ASME A112.18.1-2018 / CSA B125.1-18 / ASSE 1016  
 IAPMO file number: 8659 (for more info visit: <http://pld.iapmo.org/default.aspx>)  
 SKU for iapmo search LTA1010



# bathonomy HandShower

**Devon**

Hand Shower  
Wall Mount - 1"

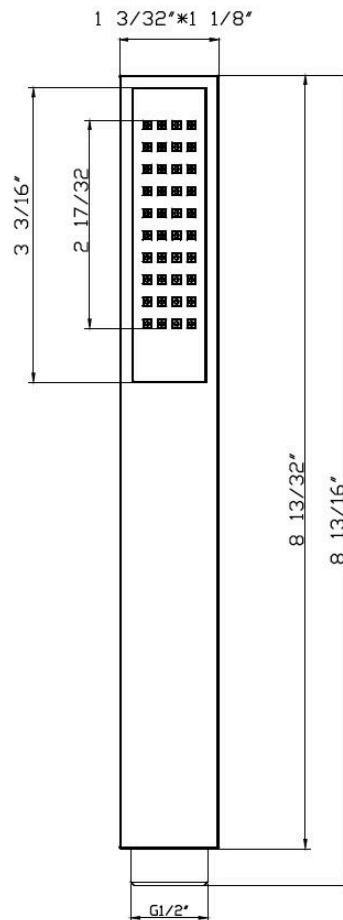

## Technical Information

All product dimensions are nominal.

## Notes

Install the product according to the installation guide.





# bathonomy ShowerHose

## ShowerComplements

Hand Shower Hose  
Wall Mount - 5"

### Features

Traditional and modern hand shower hose of our Shower Complements family, a family of components where you will find what you need to complete the installation of your shower. Available in different finishes.

- Hand shower hose
- 60 in. length
- Round connector on each end.
- Rubber washer on the bracket connector to prevent slipping.
- NPT 1/2 in. inlet and outlet connections.

### Material

- Premium material construction with metal handle ensures reliability and durability.
- BATHONOMY finishes resist corrosion and tarnishing.
- Stainless steel construction

### Dimensions

- W: 120" \* / Ø: 0.5"

### Weight

- 0.3 lb.



### Codes/Standards

COF.HHO.SCO.05.00.SS.BNI

### BATHONOMY Faucet Lifetime Limited Warranty

See website for detailed warranty information.

### Available Colors/Finishes

*Color tiles intended for reference only.*

Color	Code	Description
	BNI	Brushed Nickel
	MBL	Matt Black
	PCH	Polished Chrome
	SBR	Satin Br



**Codes / Standards compliance:** Uniform Plumbing Code (UPC)  
 National Plumbing Code of Canada  
 ASME A112.18.1-2018 / CSA B125.1-18 / ASSE 1016  
 IAPMO file number: 8659 (for more info visit: <http://pld.iapmo.org/default.aspx>)  
 SKU for iapmo search LTA1010



# bathonomy Shower Mixer

**Devon**

2 Way Pressure Balance Shower Mixer - Wall Mount - 2"

## Features

- Pressure balance rough-in valve with 2 way diverter.
  - Two way selectable through a diverter
- Shut-off valves and integrated anti-return valves.
  - Temperature and flow limiter incorporated in cartridge.
- Pressure balance cartridge adjust inlet pressure fluctuations.
- Pressure balance cartridge prevent scalding, cold water supply stops when cold water pressure fail.
- Maximun outlet temperature and flow can be limited.
- Minimun working pressure: 20 Psi (1.4 Bar).
- Maximun working pressure: 125 Psi (8 bar).
- Recommended working pressure: 45 Psi (3 Bar).
- Maximun test pressure: 500 Psi (35 Bar)
- Hot water inlet max. temperature: 180°F (80°C)
- Water inlet and outlet threads: Male 1/2 in. NPT

## Material

- Premium material construction with metal handle ensures reliability and durability.
- BATHONOMY finishes resist corrosion and tarnishing.
- Brass

## Dimensions

- W: 5.31" \* H: 6.31" \* D: 3"

## Weight

- 4.4 lb.



## Codes/Standards

COF.SHM.DEV.02.00.BR.BNI





## BATHONOMY Faucet Lifetime Limited Warranty

See website for detailed warranty information.

## Available Colors/Finishes

*Color tiles intended for reference only.*

### Color Code Description

	BNI	Brushed Nickel
	MBL	Matt Black
	PCH	Polished Chrome
	SBR	Satin Brass

## Codes / Standards compliance:



Uniform Plumbing Code (UPC)  
National Plumbing Code of Canada  
ASME A112.18.1-2018 / CSA  
B125.1-18



IAPMO file number: 8659 (for more info visit: <http://pld.iapmo.org/default.aspx>)

SKU for iapmo search LTA1010



# bathonomy ShowerMixer

Devon

2 Way Pressure Balance Shower Mixer - Wall Mount - 2"

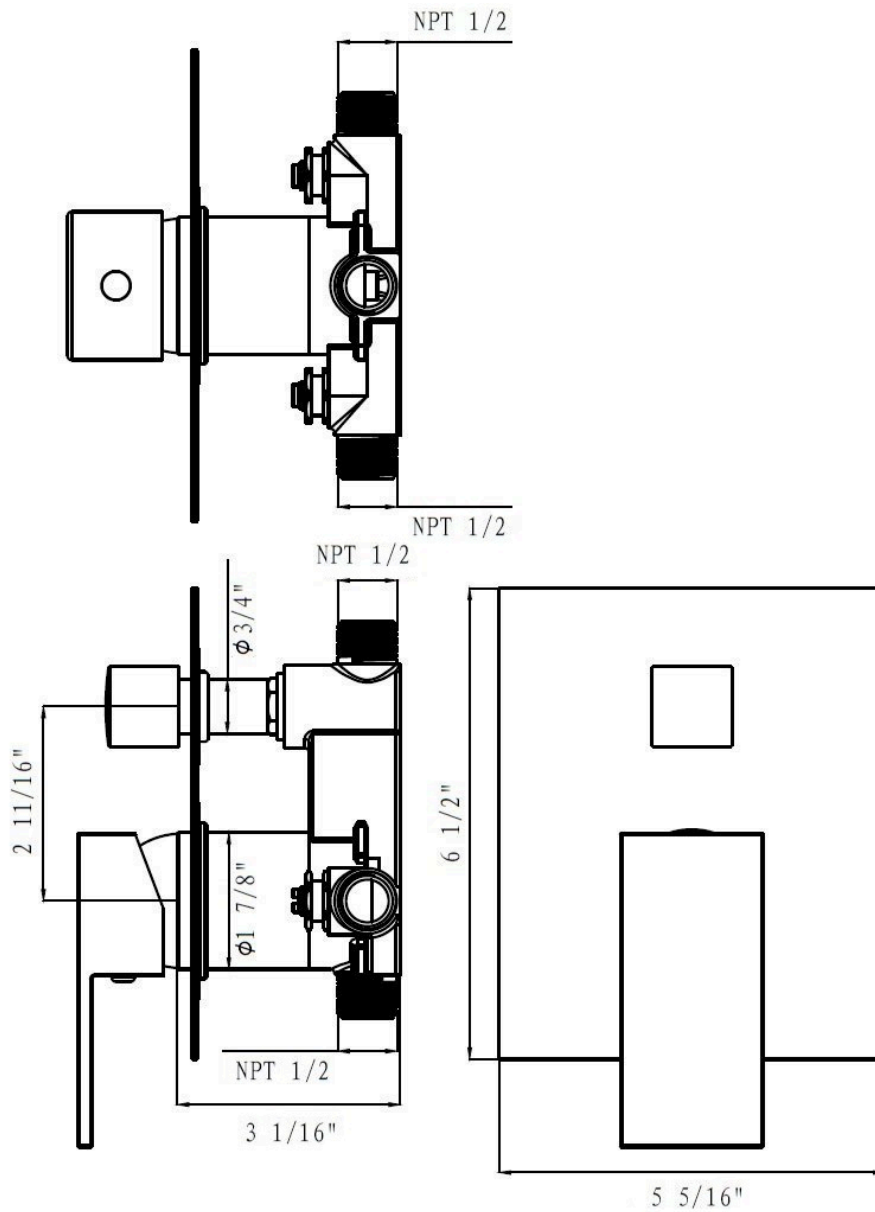

### Technical Information

All product dimensions are nominal.

Shower head included: No

Shower arm: No

### Notes

Install the product according to the installation guide.