



bathonomy Shower Arm

Devon

Shower Arm Ceiling Mount - 8"

Features

Modern shower arm of our Devon family, a family of components for your shower with a square and modern design that will delight your daily shower. This family covers everything you need to build your bathroom area: mixers, heads, hand showers, connectors, tub spout, etc. Available in different finishes.

- Shower arm.
- NPT 1/2 in. inlet
- G 1/2 in. outlet
- Rustproof: Yes

Material

- Premium material construction with metal handle ensures reliability and durability.
- BATHONOMY finishes resist corrosion and tarnishing.
- Brass construction

Dimensions

- W: 1" * H: 5.25" * D: 1"

Weight

- 1.1 lb.



Codes/Standards

COF.SHA.DEV.04.00.BR.PCH

BATHONOMY Faucet Lifetime Limited Warranty

See website for detailed warranty information.

Available Colors/Finishes

Color tiles intended for reference only.

Color	Code	Description
	BNI	Brushed Nickel
	MBL	Matt Black
	PCH	Polished Chrome
	SBR	Satin Brass



Codes / Standards compliance: Uniform Plumbing Code (UPC)
 National Plumbing Code of Canada
 ASME A112.18.1-2018 / CSA B125.1-18 / ASSE 1016
 IAPMO file number: 8659 (for more info visit: <http://pld.iapmo.org/default.aspx>)
 SKU for iapmo search LTA1010

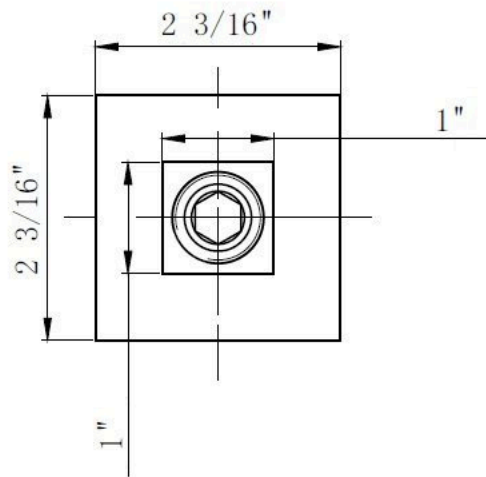
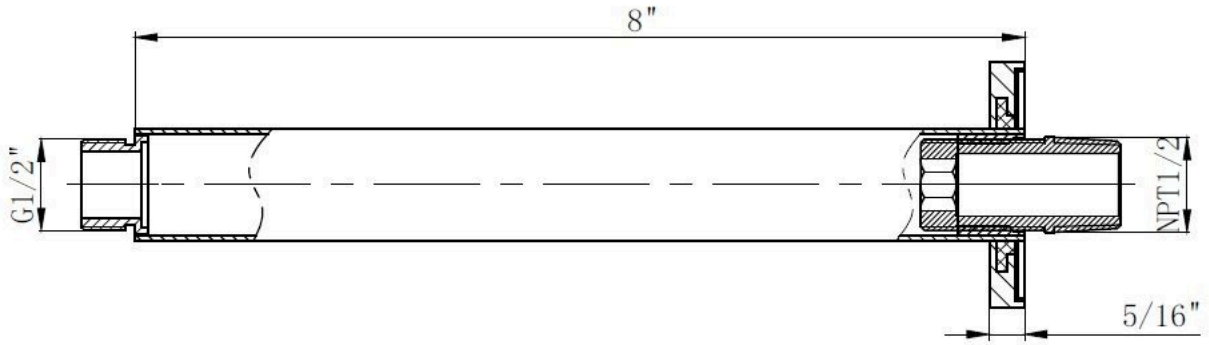

Technical Information

All product dimensions are nominal.

Notes

Install the product according to the installation guide.



bathonomy ShowerHead

Devon

Sharp Nozzles Shower Head Wall
Or Ceiling Mount - 12"

Features

Modern shower head of our Devon family, a family of components for your shower with a square and modern design that will delight your daily shower. This family covers everything you need to build your bathroom area: mixers, heads, hand showers, connectors, tub spout, etc. Available in different finishes and sizes.

- Shower head
- Thin design (5mm / 0.2 in.)
- G 1/2 in. inlet
- Silicone sharp nozzles easy to clean
- 1.8 Gpm
- Rustproof: Yes

Material

- Premium material construction with metal handle ensures reliability and durability.
- BATHONOMY finishes resist corrosion and tarnishing.
- Stainless steel construction

Dimensions

- W: 12" * H: 0.2" * D: 12"

Weight

- 4.6 lb.

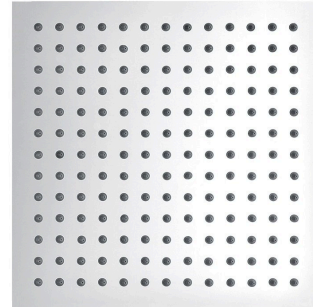

Codes/Standards

COF.SHH.DEV.12.00.SS.PSS

BATHONOMY Faucet Lifetime Limited Warranty

See website for detailed warranty information.

Available Colors/Finishes

Color tiles intended for reference only.

Color Code Description

Color	Code	Description
	BSS	Brushed Stainless Steel
	MBL	Matt Black
	PSS	Polished Stainless Steel
	SBR	Satin Brass



Codes / Standards compliance: Uniform Plumbing Code (UPC)

National Plumbing Code of Canada

ASME A112.18.1-2018 / CSA B125.1-18 / ASSE 1016

IAPMO file number: 8659 (for more info visit: <http://pld.iapmo.org/default.aspx>)

SKU for iapmo search LTA1010



bathonomy ShowerHead

Devon

Sharp Nozzles Shower Hea Wall
Or Ceiling Mount - 12"

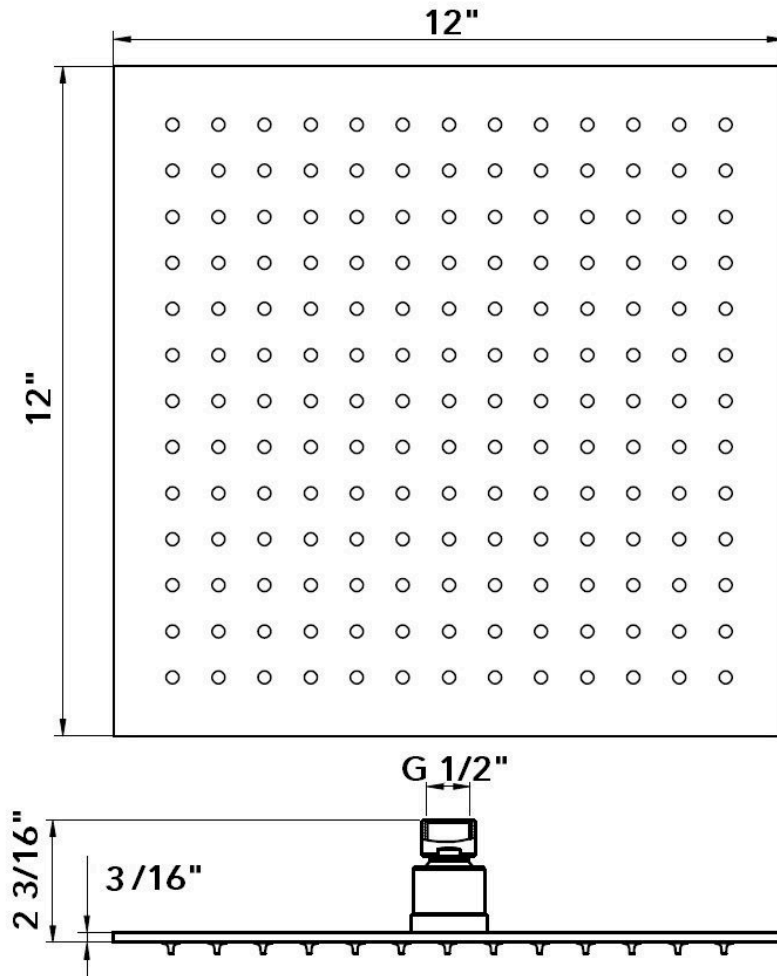

Technical Information

All product dimensions are nominal.

Notes

Install the product according to the installation guide.



bathonomyHandShowerConnetor

Devon

Hand Shower Holder
Connetor Wall Mount - 3"

Features

Modern hand shower hose holder with connector of our Devon family, a family of components for your shower with a square and modern design that will delight your daily shower. This family covers everything you need to build your bathroom area: mixers, heads, hand showers, connectors, tub spout, etc. Available in different finishes and functions.

- Hose connector with holder
- Adjustable scutcheon
- NPT 1/2 in. inlet
- G 1/2 in. outlet



Codes/Standards

COF.HHC.DEV.03.00.BR.PCH

Material

- Premium material construction with metal handle ensures reliability and durability.
- BATHONOMY finishes resist corrosion and tarnishing.
- Brass construction





BATHONOMY Faucet Lifetime Limited Warranty

See website for detailed warranty information.

Available Colors/Finishes

Color tiles intended for reference only.

Color Code Description

	BNI	Brushed Nickel
	MBL	Matt Black
	PCH	Polished Chrome
	SBR	Satin Brass

Dimensions

- W: 3" * H: 2.36" * D: 3.25"

Weight

- 1.7 lb.



Codes / Standards compliance: Uniform Plumbing Code (UPC)

National Plumbing Code of Canada

ASME A112.18.1-2018 / CSA B125.1-18 / ASSE 1016

IAPMO file number: 8659 (for more info visit: <http://pld.iapmo.org/default.aspx>)

SKU for iapmo search LTA1010



bathonomyHandShowerConnector

Devon

Hand Shower Holder
Connector Wall Mount - 3"

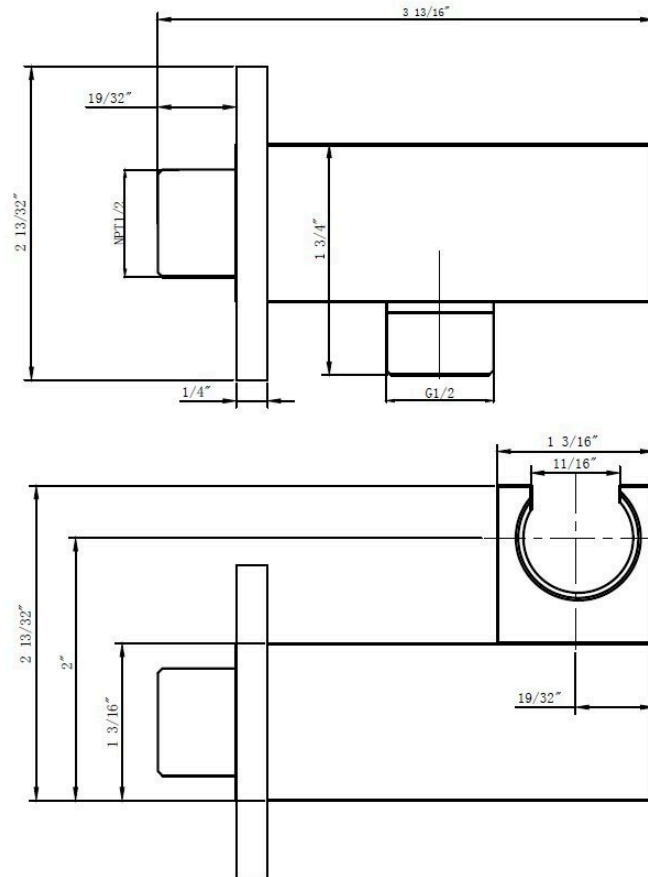

Technical Information

All product dimensions are nominal.

Notes

Install the product according to the installation guide.



bathonomyHandShower

Devon

Hand Shower
Wall Mount - 1"

Features

Modern hand shower of our Devon family, a family of components for your shower with a square and modern design that will delight your daily shower. This family covers everything you need to build your bathroom area: mixers, heads, tubes, connectors, tub spout, etc. Available in different finishes and functions.

- Hand shower
- Only rain function
- 1.8 Gpm.
- G 1/2" inlet
- With back flow prevention check valve

Material

- Premium material construction with metal handle ensures reliability and durability.
- BATHONOMY finishes resist corrosion and tarnishing.
- Brass construction
- Silicone sharp nozzle easy to clean.

Dimensions

Weight: 1.12" * H: 8.25" * D: 1.12"

- 0.3 lb.



Codes/Standards



COF.HSH.DEV.01.00.AB.PCH

BATHONOMY Faucet Lifetime Limited Warranty

See website for detailed warranty information.

Available Colors/Finishes

Color tiles intended for reference only.

Color	Code	Description
	BNI	Brushed Nickel
	MBL	Matt Black
	PCH	Polished Chrome
	SBR	Satin Brass



Codes / Standards compliance: Uniform Plumbing Code (UPC)
 National Plumbing Code of Canada
 ASME A112.18.1-2018 / CSA B125.1-18 / ASSE 1016
 IAPMO file number: 8659 (for more info visit: <http://pld.iapmo.org/default.aspx>)
 SKU for iapmo search LTA1010



bathonomy HandShower

Devon

Hand Shower
Wall Mount - 1"

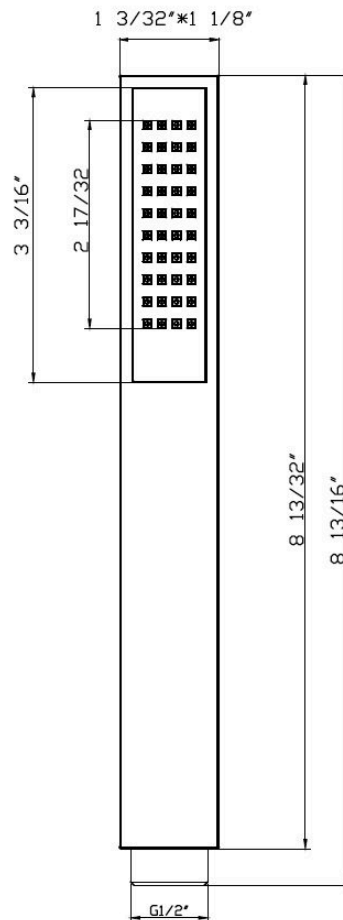

Technical Information

All product dimensions are nominal.

Notes

Install the product according to the installation guide.



bathonomy ShowerHose

ShowerComplements

Hand Shower Hose
Wall Mount - 5"

Features

Traditional and modern hand shower hose of our Shower Complements family, a family of components where you will find what you need to complete the installation of your shower. Available in different finishes.

- Hand shower hose
- 60 in. length
- Round connector on each end.
- Rubber washer on the bracket connector to prevent slipping.
- NPT 1/2 in. inlet and outlet connections.

Material

- Premium material construction with metal handle ensures reliability and durability.
- BATHONOMY finishes resist corrosion and tarnishing.
- Stainless steel construction

Dimensions

- W: 120" * / Ø: 0.5"

Weight

- 0.3 lb.



Codes/Standards





COF.HHO.SCO.05.00.SS.PCH

BATHONOMY Faucet Lifetime Limited Warranty

See website for detailed warranty information.

Available Colors/Finishes

Color tiles intended for reference only.

Color	Code	Description
	BNI	Brushed Nickel
	MBL	Matt Black
	PCH	Polished Chrome
	SBR	Satin Br



Codes / Standards compliance: Uniform Plumbing Code (UPC)
 National Plumbing Code of Canada
 ASME A112.18.1-2018 / CSA B125.1-18 / ASSE 1016
 IAPMO file number: 8659 (for more info visit: <http://pld.iapmo.org/default.aspx>)
 SKU for iapmo search LTA1010



bathonomy Shower Mixer

Devon

2 Way Pressure Balance Shower Mixer - Wall Mount - 2"

Features

- Pressure balance rough-in valve with 2 way diverter.
 - Two way selectable through a diverter
- Shut-off valves and integrated anti-return valves.
 - Temperature and flow limiter incorporated in cartridge.
- Pressure balance cartridge adjust inlet pressure fluctuations.
- Pressure balance cartridge prevent scalding, cold water supply stops when cold water pressure fail.
- Maximun outlet temperature and flow can be limited.
- Minimun working pressure: 20 Psi (1.4 Bar).
- Maximun working pressure: 125 Psi (8 bar).
- Recommended working pressure: 45 Psi (3 Bar).
- Maximun test pressure: 500 Psi (35 Bar)
- Hot water inlet max. temperature: 180°F (80°C)
- Water inlet and outlet threads: Male 1/2 in. NPT

Material

- Premium material construction with metal handle ensures reliability and durability.
- BATHONOMY finishes resist corrosion and tarnishing.
- Brass

Dimensions

- W: 5.31" * H: 6.31" * D: 3"

Weight

- 4.4 lb.



Codes/Standards

COF.SHM.DEV.02.00.BR.PCH





BATHONOMY Faucet Lifetime Limited Warranty

See website for detailed warranty information.

Available Colors/Finishes

Color tiles intended for reference only.

Color Code Description

	BNI	Brushed Nickel
	MBL	Matt Black
	PCH	Polished Chrome
	SBR	Satin Brass

Codes / Standards compliance:



Uniform Plumbing Code (UPC)
 National Plumbing Code of Canada
 ASME A112.18.1-2018 / CSA
 B125.1-18 / ASSE 1016
 IAPMO file number: 8659 (for more
 info visit: [http://pld.iapmo.org/
 default.aspx](http://pld.iapmo.org/default.aspx))
 SKU for iapmo search LTA1010





bathonomy ShowerMixer

Devon

2 Way Pressure Balance Shower Mixer - Wall Mount - 2"

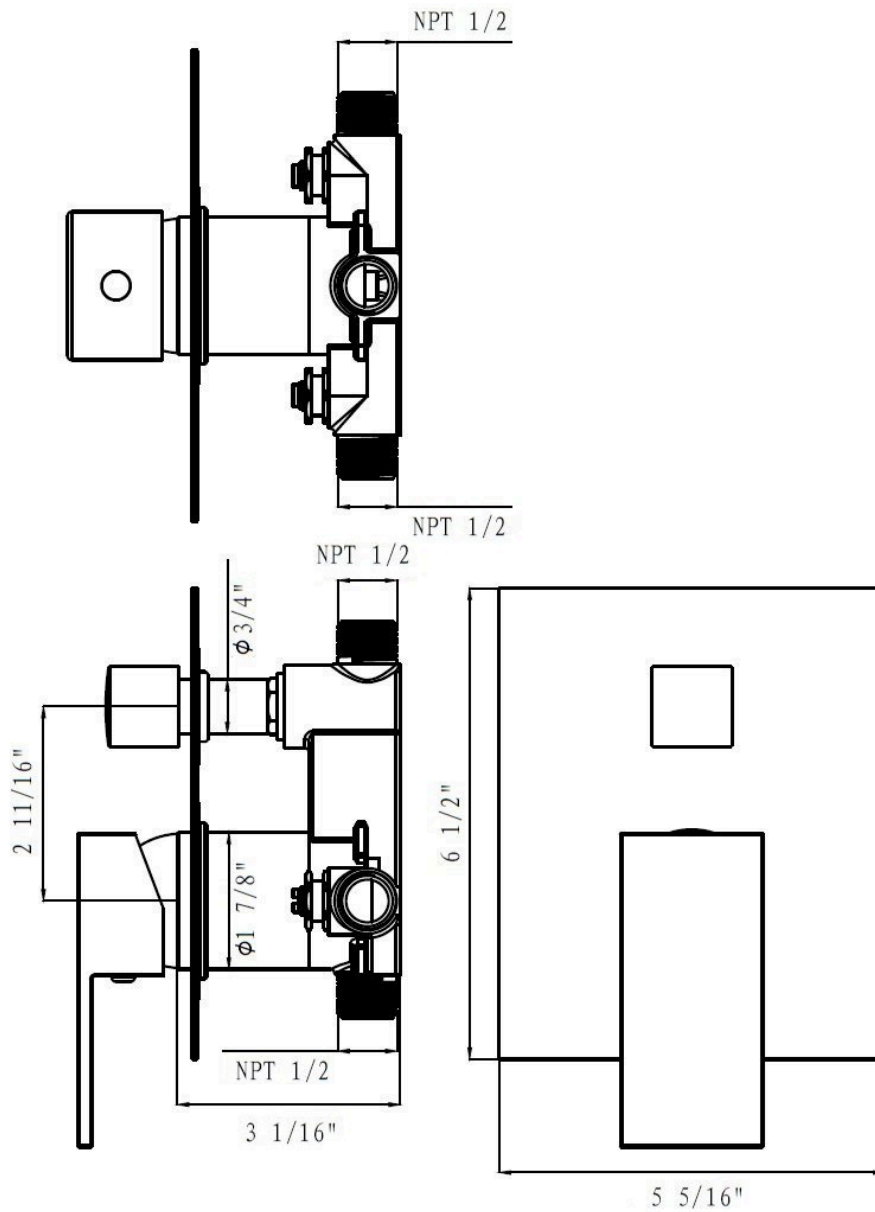

Technical Information

All product dimensions are nominal.

Shower head included: No

Shower arm: No

Notes

Install the product according to the installation guide.