



bathonomyHandShowerConnetor

Metro

Hand Shower Connetor
Wall Mount - 2"

Features

Modern hand shower hose connector of our Metro family, a family of components for your shower with a round and modern design that will delight your daily shower. This family covers everything you need to build your bathroom area: mixers, heads, hand showers, connectors, tub spout, etc. Available in different finishes and functions.

- Hose connector
- Fixed scutcheon, cannot be adjusted
- NPT 1/2 in. inlet
- G 1/2 in. outlet

Material

- Premium material construction with metal handle ensures reliability and durability.
- BATHONOMY finishes resist corrosion and tarnishing.
- Brass construction

Dimensions

- D: 1.62" / Ø: 2.12"

Weight

- 0.4 lb.



Codes/Standards



COF.HCO.MTO.02.00.BR.BNI

BATHONOMY Faucet Lifetime Limited Warranty

See website for detailed warranty information.

Available Colors/Finishes

Color tiles intended for reference only.

Color	Code	Description
	BNI	Brushed Nickel
	MBL	Matt Black
	PCH	Polished Chrome
	SBR	Satin Brass



Codes / Standards compliance: Uniform Plumbing Code (UPC)
 National Plumbing Code of Canada
 ASME A112.18.1-2018 / CSA B125.1-18 / ASSE 1016
 IAPMO file number: 8659 (for more info visit: <http://pld.iapmo.org/default.aspx>)
 SKU for iapmo search LTA1010



bathonomyHandShowerConnetor

Metro

Hand Shower Connetor
Wall Mount - 2"

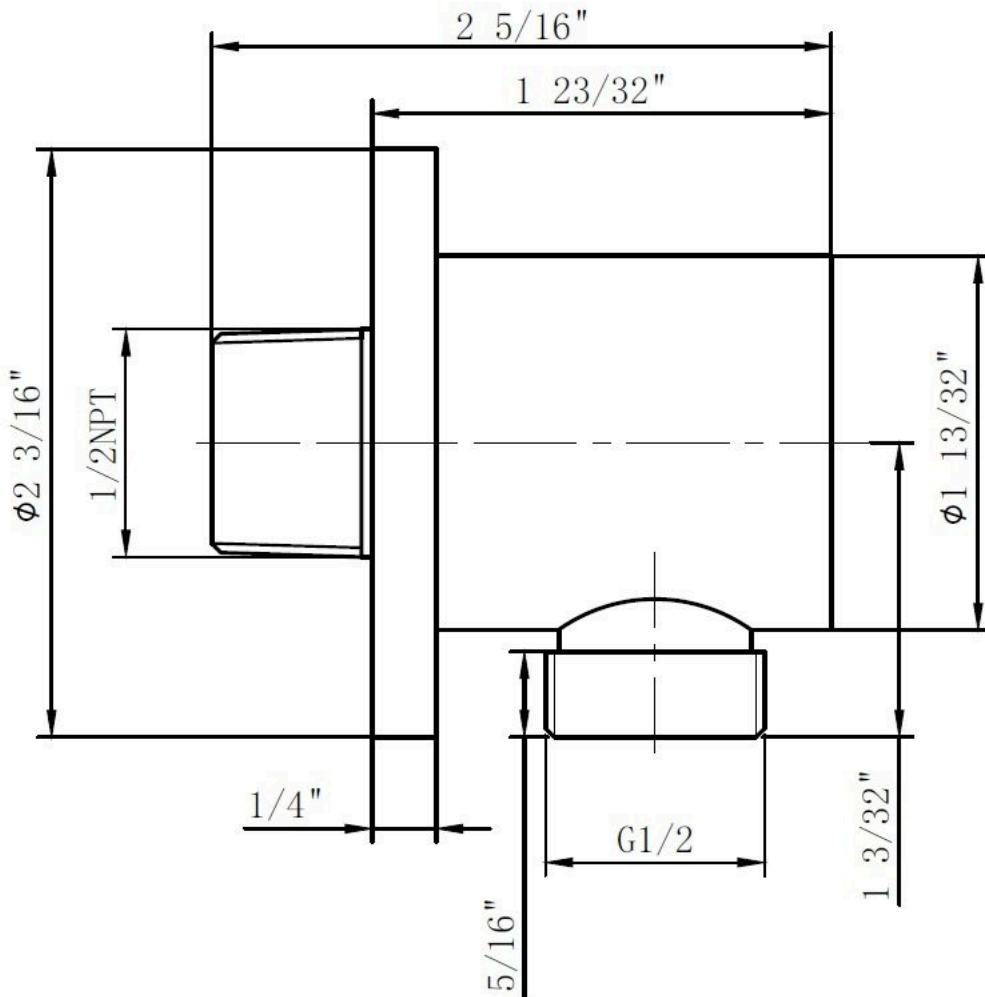

Technical Information

All product dimensions are nominal.

Notes

Install the product according to the installation guide.



bathonomy ShowerHose

ShowerComplements

Hand Shower Hose
Wall Mount - 5"

Features

Traditional and modern hand shower hose of our Shower Complements family, a family of components where you will find what you need to complete the installation of your shower. Available in different finishes.

- Hand shower hose
- 60 in. length
- Round connector on each end.
- Rubber washer on the bracket connector to prevent slipping.
- NPT 1/2 in. inlet and outlet connections.

Material

- Premium material construction with metal handle ensures reliability and durability.
- BATHONOMY finishes resist corrosion and tarnishing.
- Stainless steel construction

Dimensions

- W: 120" * / Ø: 0.5"

Weight

- 0.3 lb.



Codes/Standards





COF.HHO.SCO.05.00.SS.BNI

BATHONOMY Faucet Lifetime Limited Warranty

See website for detailed warranty information.

Available Colors/Finishes

Color tiles intended for reference only.

Color	Code	Description
	BNI	Brushed Nickel
	MBL	Matt Black
	PCH	Polished Chrome
	SBR	Satin Br



Codes / Standards compliance: Uniform Plumbing Code (UPC)
 National Plumbing Code of Canada
 ASME A112.18.1-2018 / CSA B125.1-18 / ASSE 1016
 IAPMO file number: 8659 (for more info visit: <http://pld.iapmo.org/default.aspx>)
 SKU for iapmo search LTA1010



bathonomyHandShower

Luk 2

Hand Shower Column - Wall Mount - 27"

Features

Shower bar without accessories Luk 2 family. Made in full brass this bar will make your shower look like the first day resisting the passage of time. It has of support for the hand shower adjustable in height and with head adjustable in inclination. Complete this bar with the necessary accessories from our Luk 2 or Cubic series. Available in different finishes.

- Support for hand shower adjustable in height and inclination.
- Made in full brass.
- You need to complete this product with hose, connector and hand shower.

Material

- Premium material construction with metal handle ensures reliability and durability.
- BATHONOMY finishes resist corrosion and tarnishing.
- Brass construction
- Silicone sharp nozzle easy to clean.

Dimensions

- W: 5.25" * H: 27.5" * D: 3"

Weight

- 2.7 lb.



Codes/Standards

JUM.HCL.LUK.27.00.BR.BNI





BATHONOMY Faucet Lifetime Limited Warranty

See website for detailed warranty information.

Available Colors/Finishes

Color tiles intended for reference only.

Color Code Description

	BNI	Brushed Nickel
	MBL	Matt Black
	PCH	Polished Chrome
	SBR	Satin Brass



Codes / Standards compliance: Uniform Plumbing Code (UPC)

National Plumbing Code of Canada

ASME A112.18.1-2018 / CSA B125.1-18 / ASSE 1016

IAPMO file number: 8659 (for more info visit: <http://pld.iapmo.org/default.aspx>)

SKU for iapmo search LTA1010



bathonomy HandShower

Luk 2

Hand Shower Column - Wall Mount -
27"

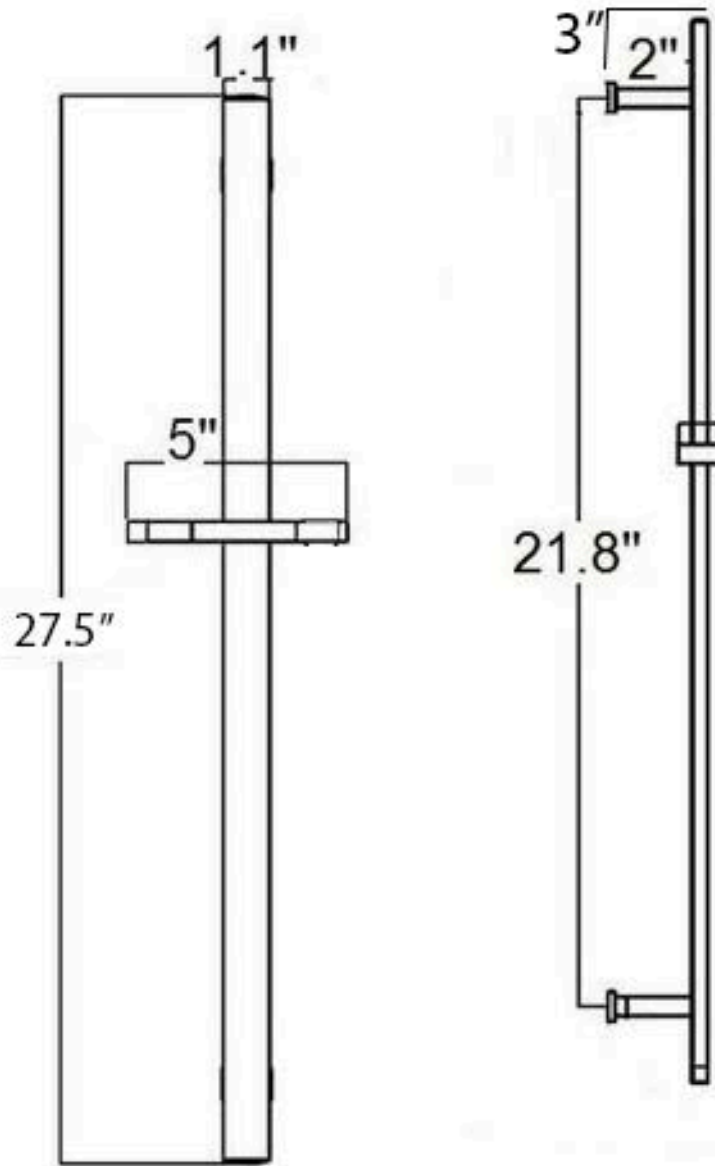

Technical Information

All product dimensions are nominal.

Notes

Install the product according to the installation guide.



bathonomyHandShower

Metro

Hand Shower
Wall Mount - 1"

Features

Modern hand shower of our Metro family, a family of components for your shower with a round and modern design that will delight your daily shower. This family covers everything you need to build your bathroom area: mixers, heads, tubes, connectors, tub spout, etc. Available in different finishes and function.

- Hand shower
- Only rain function
- 1.8 Gpm.
- G 1/2" inlet

Material

- Premium material construction with metal handle ensures reliability and durability.
- BATHONOMY finishes resist corrosion and tarnishing.
- Brass construction
- Silicone sharp nozzle easy to clean.
- With back flow prevention check valve

Dimensions

- H: 9" * / Ø: 0.93"

Weight

- 0.6 lb.



Codes/Standards

COF.HSH.MTO.01.00.BR.BNI

BATHONOMY Faucet Lifetime Limited Warranty

See website for detailed warranty information.

Available Colors/Finishes

Color tiles intended for reference only.

Color	Code	Description
	BNI	Brushed Nickel
	MBL	Matt Black
	PCH	Polished Chrome
	SBR	Satin Brass



Codes / Standards compliance: Uniform Plumbing Code (UPC)
 National Plumbing Code of Canada
 ASME A112.18.1-2018 / CSA B125.1-18 / ASSE 1016
 IAPMO file number: 8659 (for more info visit: <http://pld.iapmo.org/default.aspx>)
 SKU for iapmo search LTA1010



bathonomy HandShower

Metro

Hand Shower
Wall Mount - 1"

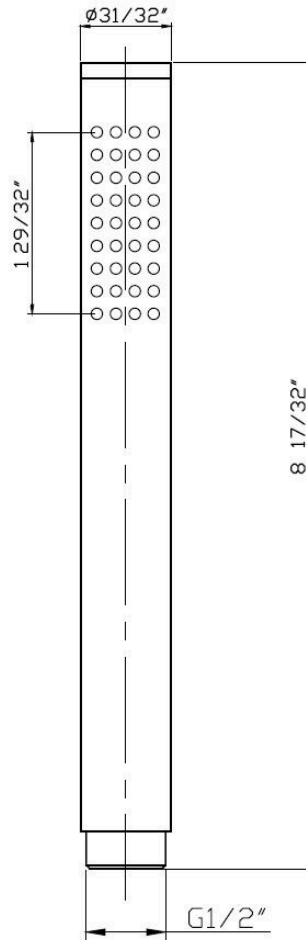

Technical Information

All product dimensions are nominal.

Notes

Install the product according to the installation guide.