

T70135-▲LHP

Submitted Model No.: _____

Specific Features: _____

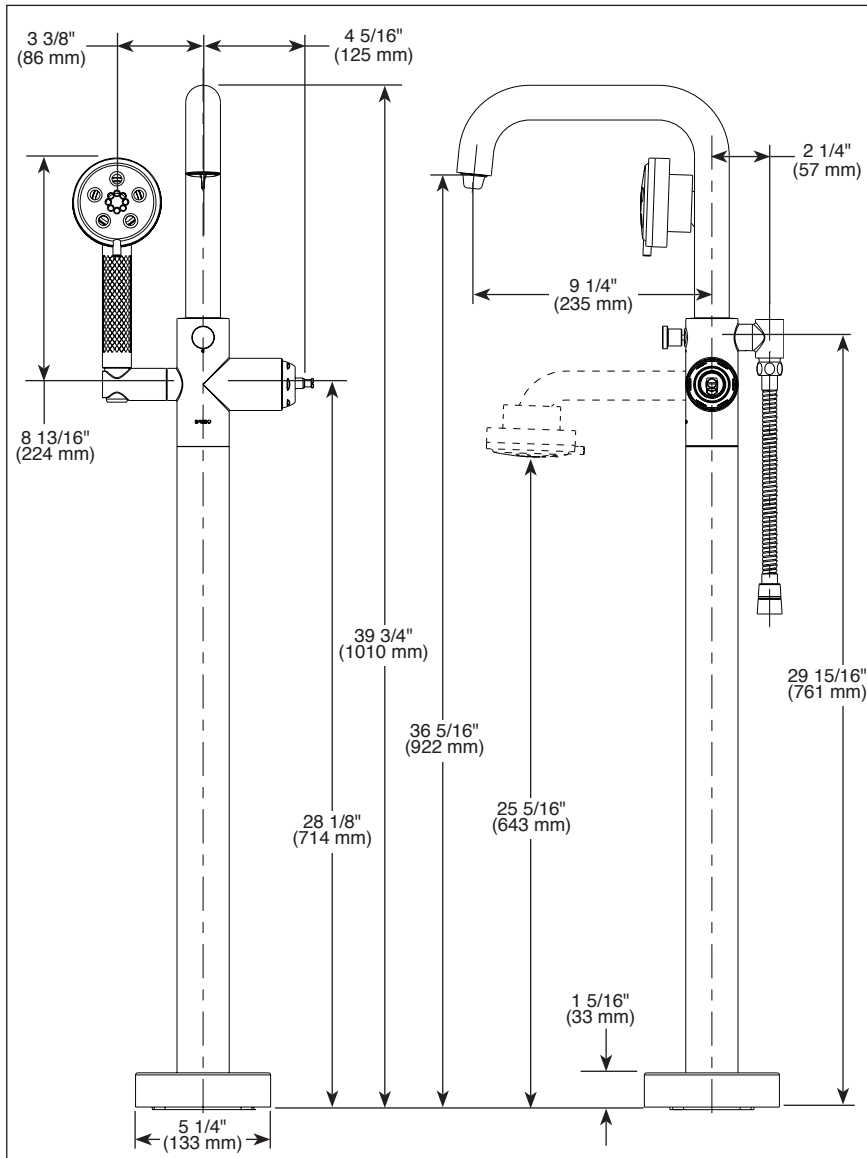

BRIZO®

SINGLE HANDLE FLOOR MOUNT TUB FILLER TRIM ONLY

- Litze® Bath Collection
- Single Handle Floor Mount

FEATURES:

- H₂Okinetic Technology®

STANDARD SPECIFICATIONS:

- Maximum handshower flow rate 1.75 gpm @ 80 psi, 6.60 L/min @ 550 kPa
- Spout flow up to 15 gpm @ 60 psi, 56.7 L/min @ 410 kPa
- Indexing handshower holder
- 60"- 82" stretchable finished metal hose
- High flow ceramic mixing cartridge
- Single lever handle with hot and cold indicators
- Auto resetting diverter
- Certified dual check valves in handshower
- Drain not included
- Requires rough-in to complete installation:
 - R70100-WS with integrated stops
 - R70100 without stops, provides maximum flow
- Handle sold separately

WARRANTY

- Parts and Finish - Lifetime limited warranty; or for commercial purchasers, 10 years for multi-family residential (apartments and condominiums) and 5 years for all other commercial uses, in each case from the date of purchase.
- Electronic Parts and Batteries (if applicable) - 5 years from the date of purchase; or for commercial purchasers, 1 year from the date of purchase. No warranty is provided on batteries.

WARNING: Risk of personal injury. Do not use the tub filler as a grab bar or support bar. Install this product according to the installation guide.



COMPLIES WITH:

- ASME A112.18.1 / CSA B125.1
- Indicates compliance to ICC/ANSI A117.1 - Valve control only
- EPA Watersense®

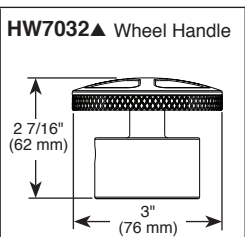
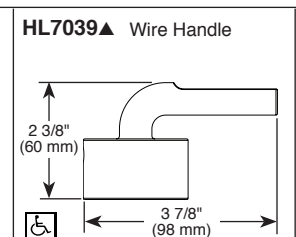
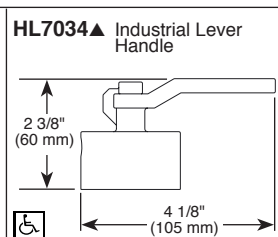
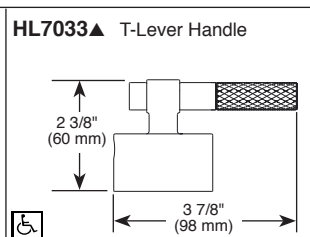
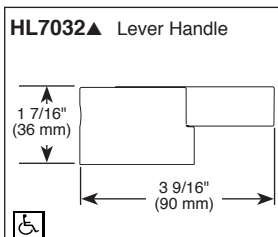

▲ Designate Finish Suffix

Brizo Kitchen & Bath Company reserves the right (1) to make changes in specifications and materials, and (2) to change or discontinue models, both without notice or obligation. Dimensions are for reference only. See current full-line price book or www.brizo.com for finish options and product availability.

BSP-B-T70135LHP Rev. E

Brizo Kitchen & Bath Company

55 E. 111th Street, Indianapolis, Indiana 46280
 350 South Edgeview Road, St. Thomas, ON N5P 4L1
 © 2020 Brizo Kitchen & Bath Company

BRIZO®

SINGLE HOLE FREESTANDING FLOOR MOUNTED TUB FILLER ROUGH-IN

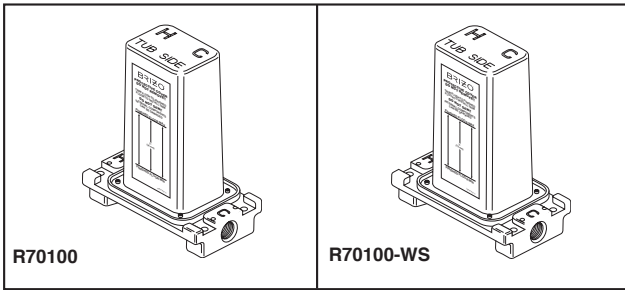

Submitted Model No.: _____

Specific Features: _____

- R70100
- R70100-WS (With Stops)

STANDARD SPECIFICATIONS:

- 1/2" NPT female inlets.
- Forged brass body.
- Available with integrated stops (R70100-WS).
- Innovative mounting system provides for simple stable installation.
- Accommodates finished floor thickness up to 3".
- Vertical spout height remains constant to finished floor.
- Pre-assembled test caps allow air or water pressure testing without trim.
- Pre-assembled protective plastersguard with information label indicating finished floor location.
- Pre-assembled gasket to isolate living space.
- Rigid galvanized installation template included (not shown).
- Refer to product installation instructions.
- Trim sold separately.

WARRANTY

- Lifetime limited warranty on parts (other than electronic parts and batteries) and finishes: or, for commercial users, for 5 years from date of purchase.
- 5 year limited warranty on electronic parts (other than batteries); or, for commercial users, for 1 year from the date of purchase. No warranty is provided on batteries.

COMPLIES WITH:

- ASME A112.18.1 / CSA B125.1

