

Model / Modelo / Modèle
R83992

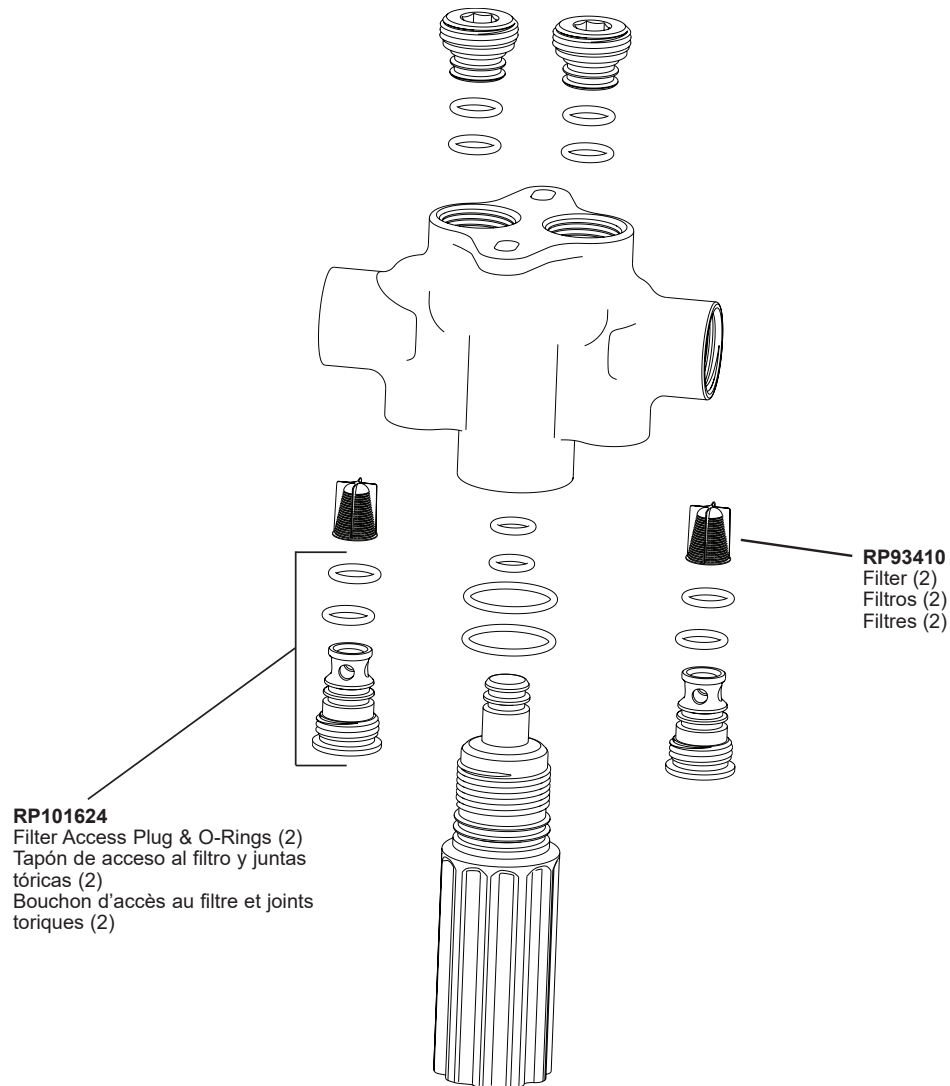

Model / Modelo / Modèle

83992-06MF-▲ & 83992-10MF-▲

RP101625
O-Rings & Clip
Anillos tóricos y
Acortar
Joints toriques et
Agrafe

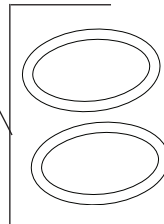
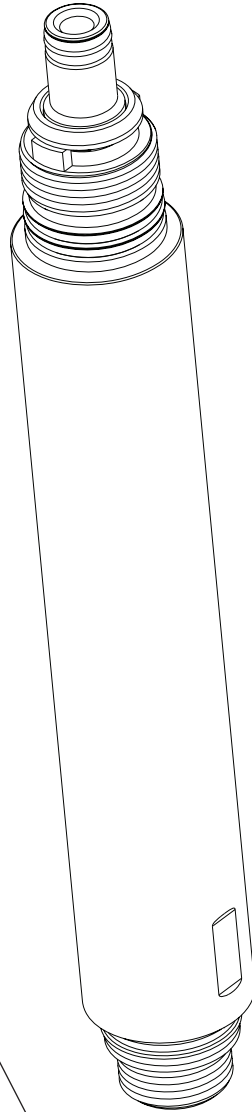
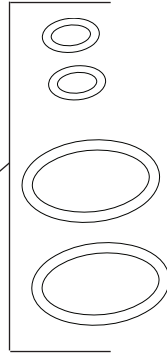

▲ Specify Finish/Especifíque el Acabado/ Précisez le fini

Models / Modelos / Modèles
T75P506-▲LHP & T75P606-▲LHP

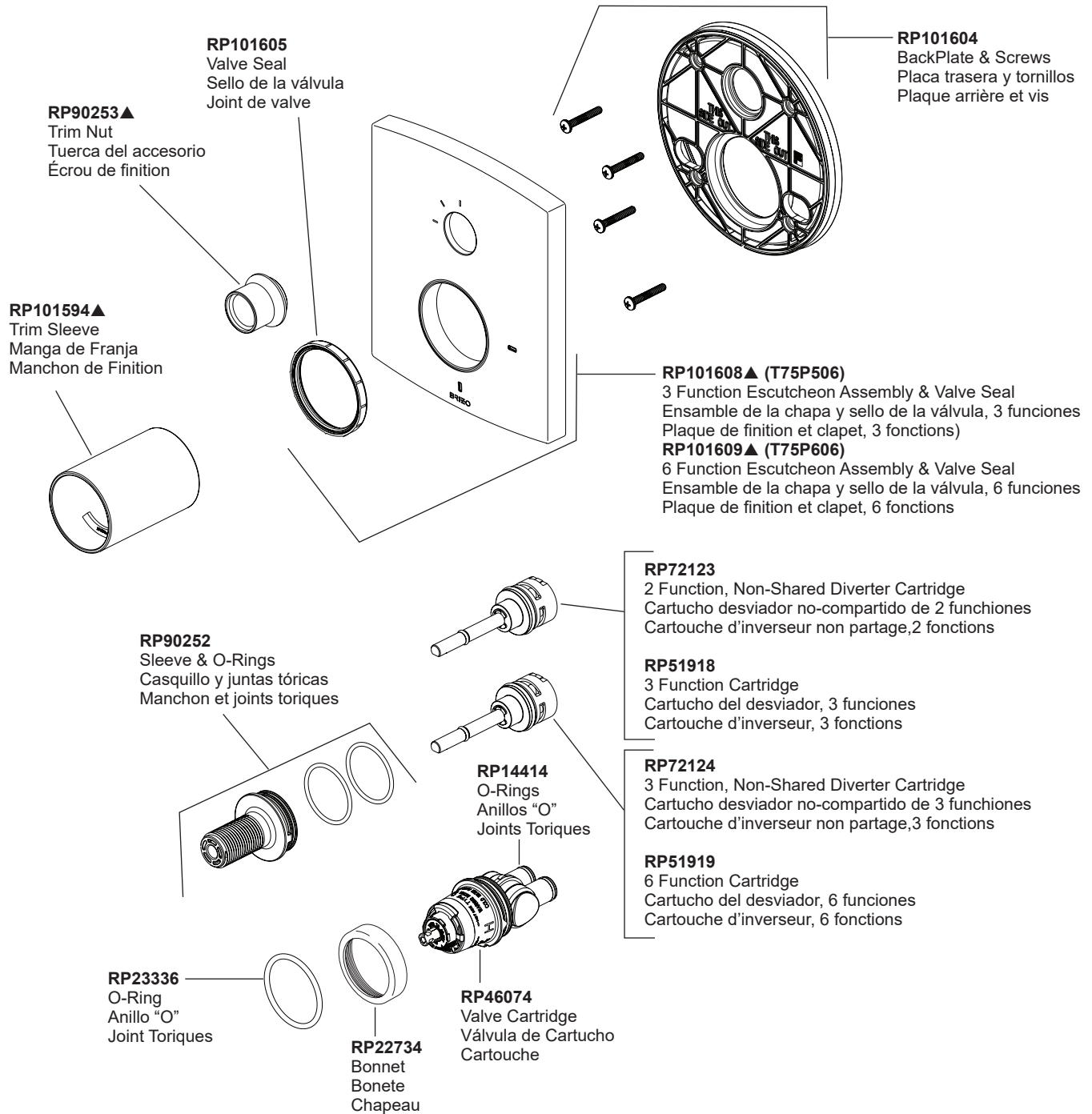

▲Specify Finish/Especifíque el Acabado/Précisez le Fini

Models / Modelos / Modèles
T75P506-▲LHP & T75P606-▲LHP

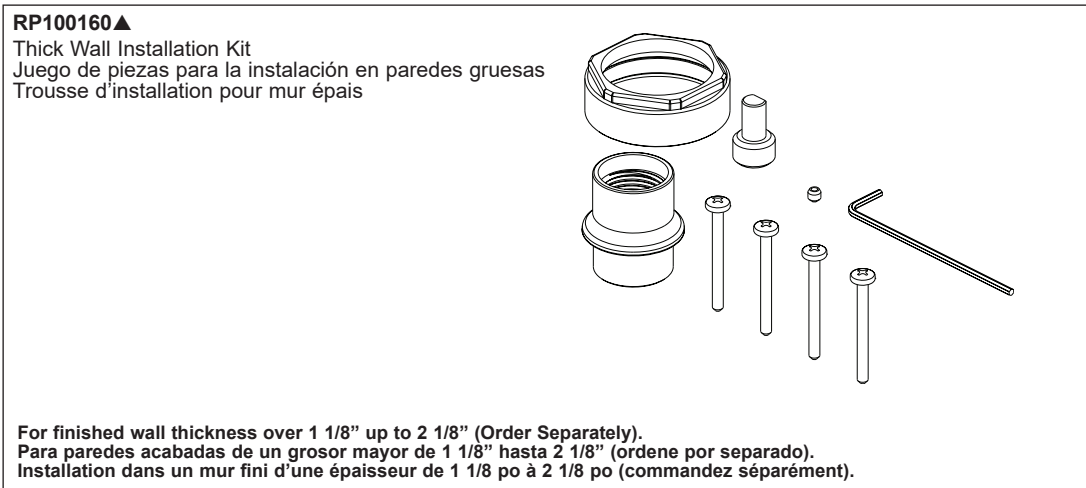
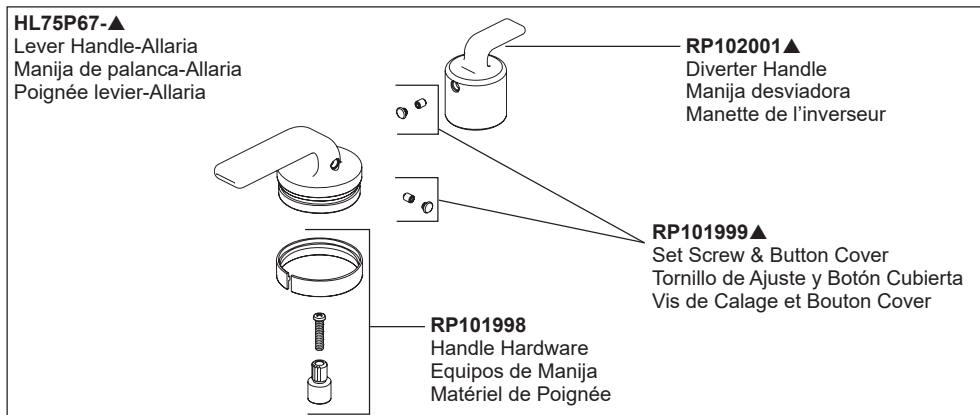
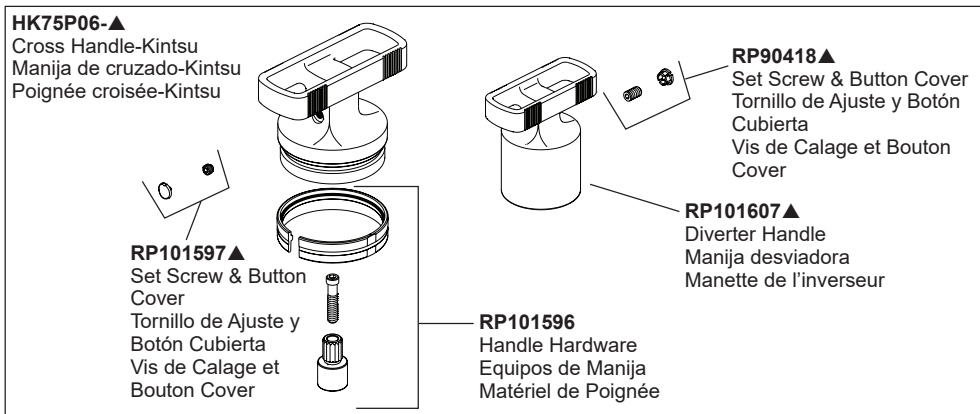
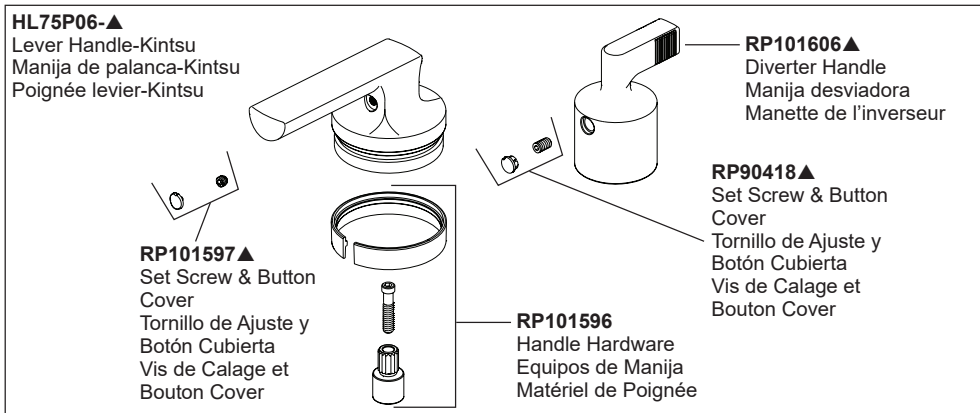

▲Specify Finish/Especifique el Acabado/Précisez le Fini

KINTSU™
Model/Modelo/Modèle
88706-▲

88806-▲
 Handshower
 Ducha de mano
 Douche à main

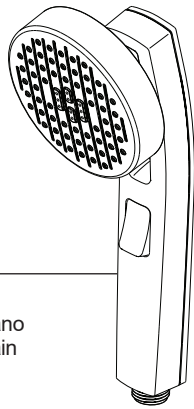

RP49645▲
 Hose & Gaskets
 Manguera con Empaques
 Tuyau avec joints

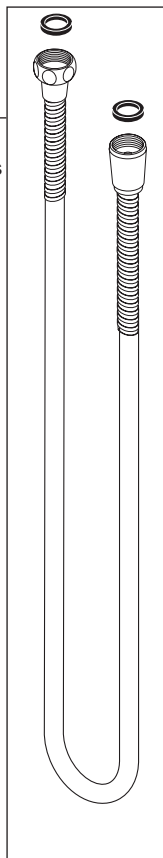

RP101579▲
 Set Screw and Button
 Cover
 Tornillo de ajuste y tapa
 de botón
 Vis de calage et bouton

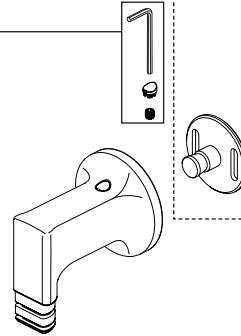

RP101578
 Mounting Hardware
 Herraje de Instalación
 Pièces de montage

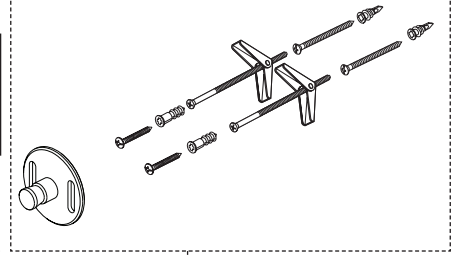

RP101577▲
 Mounting Base and Hardware
 Base de montaje y herrajes
 Base et pièces de montage



RP101581▲
 Slide Bar Handshower Holder
 Soporte para la regadera en la barra
 deslizante
 Porte-douche à main sur glissière

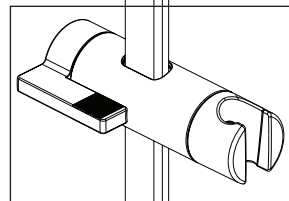

RP101580▲
 Slide Bar Assembly
 Conjunto de la Barra Corrediza
 Coulisse avec ses éléments

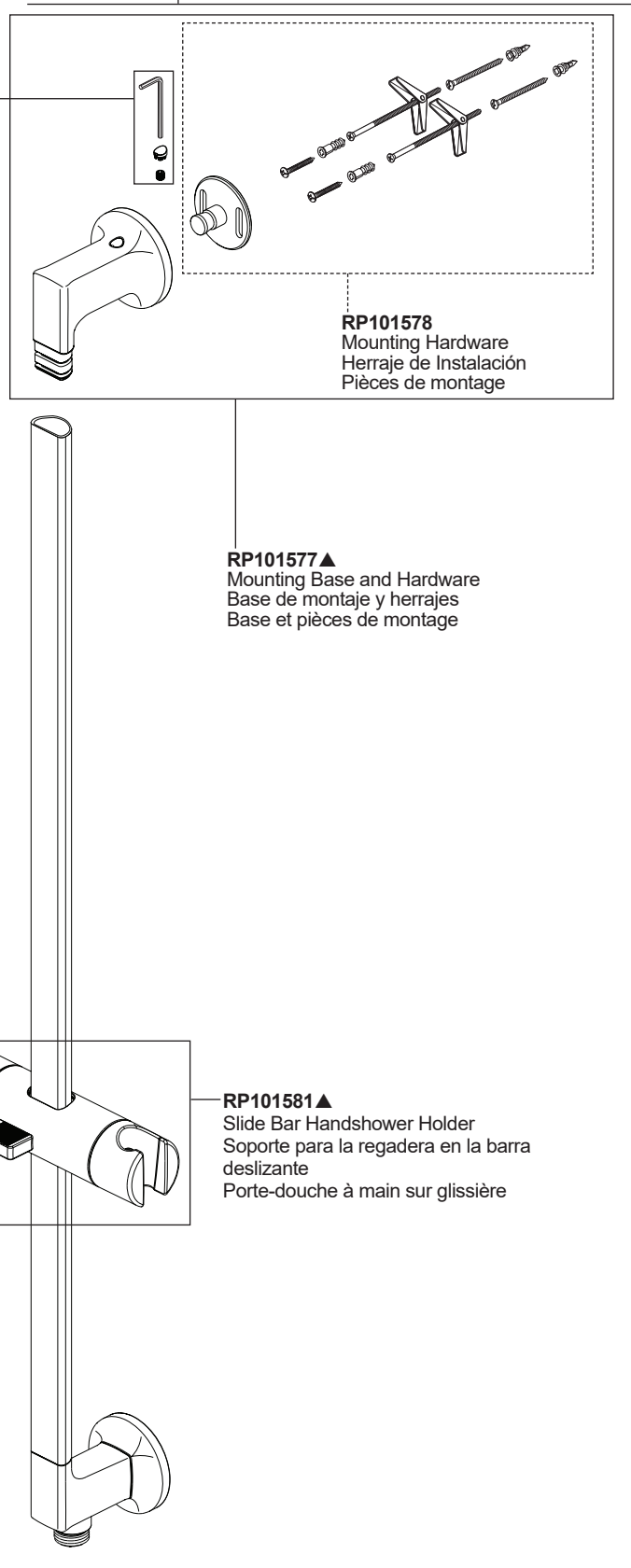

* Available base for wall mounted hose applications
 * Base disponible para aplicaciones de manguera montadas en la pared
 * Base disponible pour les applications de tuyaux fixés au mur

▲Specify Finish/Especifique el Acabado/Précisez le Fini