

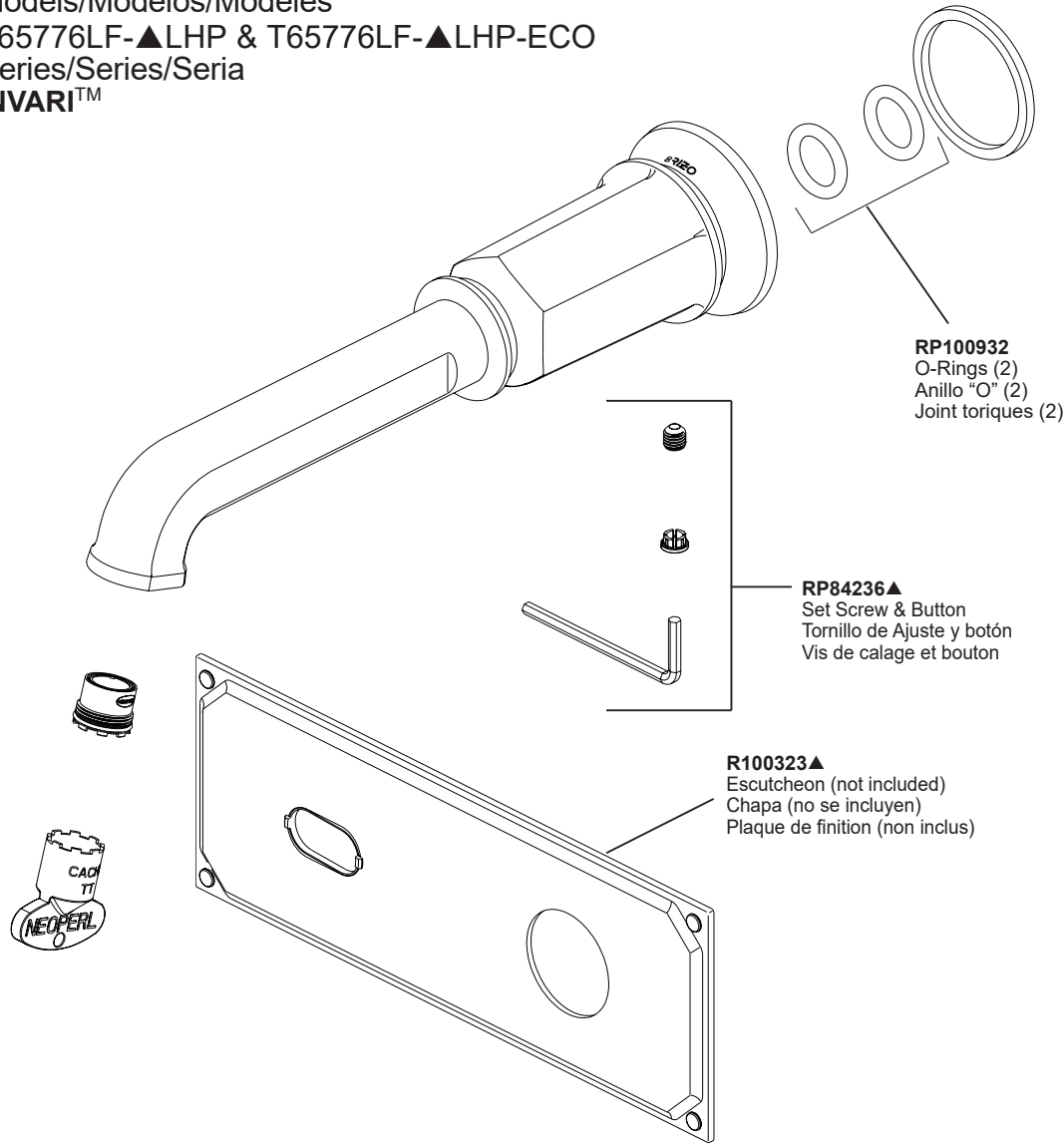

Models/Modelos/Modèles  
 T65776LF-▲LHP & T65776LF-▲LHP-ECO  
 Series/Series/Seria  
**INVARI™**

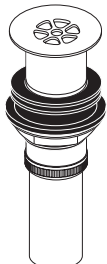
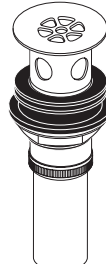
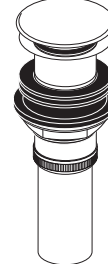
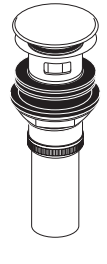

▲ Specify Finish / Especificque el Acabado / Précisez le Fini

**Optional - Drain Sold Separately / Opcional - El desagüe se vende por separado / Facultative - Renvoi vendu séparément**

 <p><b>RP72411▲</b>                  Grid Strainer without Overflow (Optional, not included)                  Cesta/colador para el Desagüe sin Rebosadero (Opcional, no incluido)                  Crépine sans trop-plein (Option, non inclus)</p>	 <p><b>RP72412▲</b>                  Grid Strainer with Overflow (Optional, not included)                  Cesta/colador para el Desagüe con Rebosadero (Opcional, no incluido)                  Crépine avec trop-plein (Option, non inclus)</p>	 <p><b>RP72413▲</b>                  Push Pop-Up without Overflow (Optional, not included)                  Control de rebose sin desagües manuales (Opcional, no incluido)                  Renvoi mécanique à poussoir sans trop-plein (Option, non inclus)</p>
 <p><b>RP72414▲</b>                  Push Pop-Up with Overflow (Optional, not included)                  Control de rebose para desagües manuales (Opcional, no incluido)                  Renvoi mécanique à poussoir avec trop-plein (Option, non inclus)</p>	 <p><b>RP81627▲</b>                  Push Pop-Up without Overflow (Optional, not included)                  Control de rebose sin desagües manuales (Opcional, no incluido)                  Renvoi mécanique à poussoir sans trop-plein (Option, non inclus)</p>	 <p><b>RP81628▲</b>                  Push Pop-Up with Overflow (Optional, not included)                  Control de rebose para desagües manuales (Opcional, no incluido)                  Renvoi mécanique à poussoir avec trop-plein (Option, non inclus)</p>

**Handles (sold separately)  
 Manijas (se vende por separado)  
 Manettes (vendu séparément)**

**RP100928▲**  
 Button Post  
 Botón de correos  
 Bouton poste

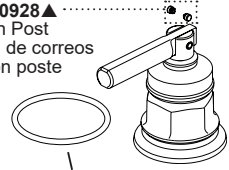

**RP100933**  
 O-Ring  
 Anillo "O"  
 Joint torique



**HL5876▲ (Lever/Palanca/Manette levier)**  
 Handles & Glide Rings  
 Manijas y aros deslizantes  
 Manettes et anneaux de glissement



**RP101184▲**  
 Cap and Friction Ring (1)  
 Tapa y aro de fricción (1)  
 Chapeau et anneau de friction (1)

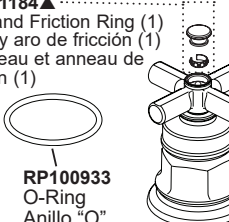

**RP100933**  
 O-Ring  
 Anillo "O"  
 Joint torique



**HX5876▲ (Cross Handle/Mango Cruzado/Traverser de Manette)**  
 Handles & Glide Rings  
 Manijas y aros deslizantes  
 Manettes et anneaux de glissement



**HK5876▲ (Knob Handle/Mango Perilla/Poignée de Manette)**  
 Handles & Glide Rings  
 Manijas y aros deslizantes  
 Manettes et anneaux de glissement



**RP100933**  
 O-Ring  
 Anillo "O"  
 Joint torique

