

KidsEmbrace®

Making Safety Fun

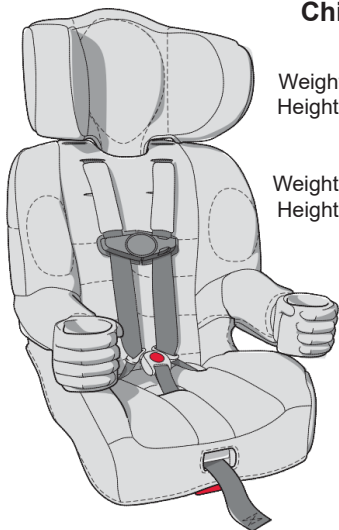

Child Requirements

5-Point Harness

Weight is: 22-65 lbs. (10-30 kg)

Height is: 29-49 in. (74-124 cm)

Belt Positioning

Weight is: 40-100 lbs. (18-45 kg)

Height is: 38-57 in. (97-145 cm)

COMBINATION HARNESS TO BOOSTER CAR SEAT

- 5 Pt. Harness Car Seat **WITH** harness is certified for use in **Motor Vehicles and Aircraft**.
- Booster Car Seat **WITHOUT** harness is certified for use in Motor Vehicles, **NOT** for Aircraft.
- Meets or exceeds all applicable requirements of Federal Motor Vehicle Safety Standard 213

WARNING!

- **Failure to follow the warnings on Booster Seat labels and in the Instruction Manual can result in death or serious injury to your child.**

Table of Contents

Table Of Contents.....	2-3
About Us	4
Registration	4
Warranty Information	5
Warnings	6-7
Car Seat Features	8-9
Use Recommendations	10-11
Toddler Car Seat Use	
22 - 65 lbs. (10 - 30 kg)	10
Booster Car Seat Use	
40 - 100 lbs. (18 - 45 kg)	11
5 Pt. Harness Installation And Use	12-27
Securing Child with 5 Pt Harness	12-15
Selecting A Vehicle Seating Location	16-17
Installation - LATCH Or Vehicle Seat Belt	18-20
LATCH Anchorage System	18
Vehicle Seat Belt and Top Tether Strap	18
Top Tether Information	19
Assistance With Installation	20
Installation With LATCH Anchorage System	20-23
Remove LATCH Anchorage System	24
Installation With Vehicle Seat Belt	25-26
Remove Vehicle Seat Belt System	27
Booster Car Seat Installation And Use	28-36
Securing Child with Booster	28-29
Selecting A Vehicle Seating Location	30-31
Securing Booster with LATCH	32
Securing Child With Lap And Shoulder Belt	32-35

Table of Contents

Operation And Adjustment	36-44
Shoulder Harness Adjustment.....	36
Changing Shoulder Harness Position	36-37
Removing Harness.....	38
Energy Absorbing Harness Pads.....	38
Changing Crotch Belt Position	39
Recline Adjustment.....	40
Installing Harness.....	41-43
Top Tether Use	44
Additional Information	45
Certification	45
Aircraft Use	45
Warm Weather Use	45
Vehicle Seat Protection	45
Car Seat Useful Life	45
Vehicle Seat Belts	46-50
5Pt Harness System	46-48
Booster Car Seat Without Harness	49
Locking Clip Use	50
Care And Cleaning	51-52
Harness Removal	51
Seat Pad Removal	51
Headrest Pad Removal	51
Cleaning	52
Seat Pad Attachment	52
Headrest Pad Attachment	52

Keep these instructions for future use.

Store instructions in pouch under pad on side of car seat.

About Us

Welcome to the KidsEmbrace family and thank you for purchasing your new KidsEmbrace Combination Booster Seat. Please make sure to carefully read through all the information in this Instruction Manual to properly use your new Combination Booster Seat.

KidsEmbrace takes safety seriously and it is our #1 priority. Each product starts with a strict internal design evaluation to assure it is a premium product. Next, we begin the extensive government compliance testing program to assure it meets/exceeds all regulatory and internal standards. Only after the completion of this lengthy process we are proud to put the KidsEmbrace brand on the product along with the global brands of our key partners.

Thank you again for choosing KidsEmbrace and enjoy your new Combination Booster Seat. If you have any questions or need assistance, please contact us at 1-866-947-3287.

Registration and Recall Information

Recall Information

Child restraints could be recalled for safety reasons. You must register this restraint in order to be reached in a recall. Send your name, address, e-mail address if available, and the restraint's model number and manufacturing date to:

KidsEmbrace

6711 Odessa Ave
Van Nuys, CA 91406-5747

or call 1-866-947-3887 or register online at
<http://www.KidsEmbrace.com/product-registration>

For recall information, call the U.S. Government's Vehicle Safety Hotline at
1-888-327-4236 (TTY: 1-800-424-9153)
or go to <http://www.nhtsa.gov>

Warranty Information

KidsEmbrace warrants products to the original retail purchaser as follows:

Limited One Year Warranty

This product is warranted against defective materials or workmanship for one year from the date of original purchase. Proof of purchase is required. The exclusive remedy for this warranty is that KidsEmbrace will at its option; provide, repair, or offer replacement components for this product or refund the original purchase price of the product. KidsEmbrace reserves the right to discontinue or change fabrics, parts, products, or to make substitutions. To make a claim under this warranty, contact KidsEmbrace Consumer Services at 1-866-947-3287.

Warranty Limitations

This warranty does not include damage which arises from negligence, misuse, or use not in accordance with the product instructions. The use of non-KidsEmbrace covers, inserts, toys, accessories, or tightening devices is not approved by KidsEmbrace. Their use could take this Booster Seat out of compliance with FMVSS 213 safety standard or negatively affect the performance. Their use automatically voids the KidsEmbrace warranty.



WARNING!

DEATH or SERIOUS INJURY can occur

- Failure to follow these instructions and car seat labels can result in injury or death to a child from striking the vehicles interior during a sudden stop or crash.
- Use only with children who are over 1 year old and who weigh between 22 and 100 lbs (10 and 45 kg) and whose height is between 29 and 57 inches (74 and 145 cm).
- Use this car seat only on vehicle seats that face forward.
- For use **WITH 5 Pt. harness system**:
 - Snugly adjust the harness belts provided with this child restraint around your child.
 - Position harness straps in harness slots at or above the shoulders.
- Secure this car seat with the vehicle's child restraint anchorage system (LATCH) if available or with a vehicle belt. Always use tether if tether anchor is available.
- Secure the top tether strap provided with this car seat as specified in both the vehicle and car seat owner manuals.
- Use only if the LATCH belt or vehicle seat belt can be tightened properly and securely.
 - The LATCH belt or vehicle seat belt must stay tightly adjusted at the belt path.
 - For harness use, do not use the lower anchors of the child restraint anchorage system (LATCH system) to attach this child restraint when restraining a child weighing more than 45 lb. (20 kg.) with the internal harnesses of the child restraint.
- Discontinue use of harness system when child's weight exceeds 65 pounds (30 kg) or shoulders are above the top shoulder belt slots.

For use WITHOUT harness system:

Use only the vehicle's lap and shoulder belt system when restraining the child in this booster seat.

Never use Booster Car Seat with only a lap belt.



WARNING!

DEATH or SERIOUS INJURY can occur

- **Discontinue use of this car seat when the top of your child's ears are above the top of the headrest.**
- **KidsEmbrace™ does not recommend the use of any car seat accessories except those manufactured by KidsEmbrace™**
- **Use of accessories or parts from other manufacturers could alter the performance of the car seat.**
- **Do not use a car seat with damaged or missing parts.**
- **Do not use cut, frayed, or damaged harness.**
- **Do not substitute parts or try to modify the car seat in any way.**
- **Do not lubricate buckles and fasteners.**
- **This car seat should be securely belted in the vehicle even when not in use. In a crash or sudden stop, an unsecured child restraint could injure other occupants.**
- **DO NOT use this car seat if it has been in a crash, it must be replaced. A crash can cause unseen damage, and continued use could result in serious injury or death.**
- **Avoid burns; car seat surfaces can become hot inside a vehicle. Always check surfaces of car seat before placing child in seat.**
- **Register your car seat with the manufacturer.**

Car Seat Features

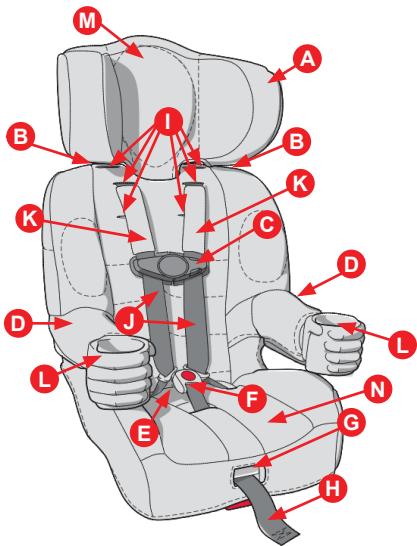

A Adjustable Headrest

B Vehicle Shoulder Belt Guides

C Harness Retainer

D Armrests

E Buckle Tongues

F Buckle & Crotch Belt

G Harness Adjustment Lever

H Harness Adjustment Strap

I Shoulder Harness Slots

J Shoulder Harness Straps

K Harness Strap Covers (optional)

L Cup Holders

M Headrest Pad

N Seat Pad

Car Seat Features

Back

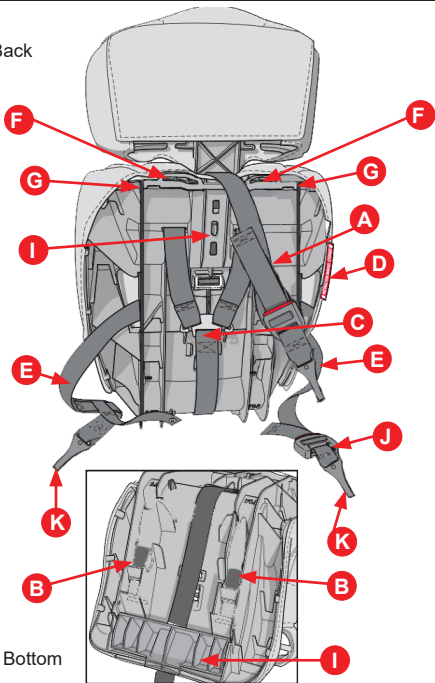

Bottom

- A** Top Tether Strap
- B** Energy Absorbing Harness Pads
- C** Metal Splitter Plate
- D** Instruction Manual Storage
- E** LATCH Lower Anchor Belt
- F** Upper Harness Slot
- G** Lower Anchor Storage
- H** Headrest Adjustment Button
- I** Recline Foot
- J** LATCH Adjuster
- K** Lower Anchor

Toddler Car Seat Use

5-Point Harness Seat Use

This car seat is designed when used as a 5 Pt. Harness for use by children who are at least 1 year old, can sit upright alone and weigh between 22 and 65 pounds (10 and 30 kg) and whose height is between 29 and 49 inches (74 and 124 cm).

This car seat can be used both as a 5 Pt. Harness Car Seat (with harness system) and as a Booster Car Seat (with the vehicle lap and shoulder belt, without the harness system).

Your child's height, weight and age determine how your car seat should be used in the vehicle and how your child should be restrained. See information below:

MUST use harness system.

Child **MUST** meet **ALL** of the following requirements:

- Child must be at least 1 year old and weigh between 22 and 65 pounds (10 and 30 kg) **and**
- Child's height is between 29 and 49 inches (74 and 124 cm) **and**
- Child is able to sit upright unassisted **and**
- Child's shoulders are below top harness slots



! WARNING!

Discontinue use of harness system when child's weight exceeds 65 pounds (30 kg) or shoulders are above the top of shoulder belt slots.

Booster Car Seat Use

Booster Seat Use

This car seat is designed when used as a booster for use by children who are at least 4 years old and weigh between 40 and 100 pounds (18 and 45 kg) and whose height is between 38 and 57 inches (97 and 145 cm).

Your child's height, weight and age determine how your car seat should be used in the vehicle and how your child should be restrained. See information below:

MUST use vehicle lap and shoulder belt and remove 5 Pt. harness system

Child **MUST** meet **ALL** of the following requirements:

- Child must be at least 4 years old and weigh between 40 and 100 pounds (18 and 45 kg) **and**
- Child's height is between 38 and 57 inches (97 and 145 cm) **and**
- Top of child's ears are below top of headrest.



WARNING!

- To avoid injuries from whiplash, top of child's ears must be below top edge of headrest on car seat.

Securing Child with 5 Pt. Harness

Child MUST be at least 1 year old, weigh between 22 and 65 pounds (10 and 30 kg), and able to sit upright unassisted.

WARNING!

- The LATCH belt or vehicle seat belt **MUST** stay tightly adjusted around car seat.
- Secure the top tether strap provided with this car seat as specified in the vehicle and child restraint owner manual.
- Use only if the LATCH belt or vehicle seat belt can be tightened properly and securely.
- For vehicles with an air bag, but without a back seat, refer to your vehicle owners manual.
- For harness use, do not use the lower anchors of the child restraint anchorage system (LATCH system) to attach this child restraint when restraining a child weighing more than 45 lb. (20 kg.) with the internal harnesses of the child restraint. Install with vehicle seat belt.
- Using this car seat with a LATCH belt or vehicle seat belt that will not stay tightly adjusted around the car seat can cause serious injury or death.

WARNING!

- **Snugly adjust harness provided with this car seat around your child.**
- **Shoulder harness MUST be through slots closest to and above the child's shoulders.**

1. Place child in car seat with lower back and rump contacting seat back (*Fig. 1*).
2. Shoulder harness straps **MUST** be routed through the proper shoulder harness slots for the child's size (*Fig. 2*).

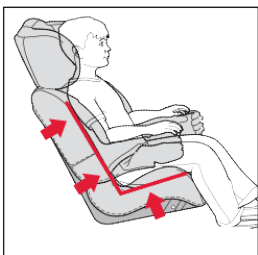

Fig. 1

- Shoulder harness straps **MUST** be through harness slots closest to and **above** child's shoulders.

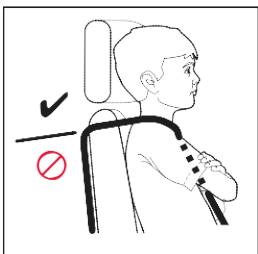

Fig. 2

To change shoulder harness slots, see "Harness Adjustment" section.

3. Position shoulder harness straps over the child's shoulders and thighs (*Fig. 3*).

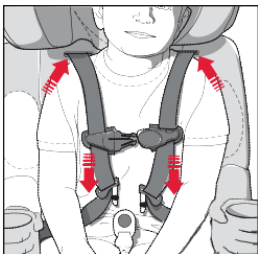
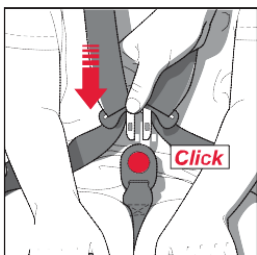

Fig. 3

5 Pt. Harness Installation and Use

4. Buckle harness.
- Insert buckle tongues into buckle until you hear a “click” (Fig. 4).



- Pull up on buckle tongues to be sure buckle is locked.

5. Snugly adjust harness.

- Pull on harness adjustment strap to tighten harness (Fig. 5).

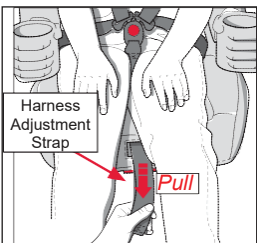

Note

- Harness should allow one finger to snugly pass between shoulder harness strap and child's shoulder.

- A snug strap should not allow any slack and should lie in a relatively straight line without sagging. It should not press on the child's flesh or push the child's body into an unnatural position.

WARNING!

- For harness use, do not use the lower anchors of the child restraint anchorage system (LATCH system) to attach this child restraint when restraining a child weighing more than 45 lb. (20 kg.) with the internal harnesses of the child restraint. Install with vehicle seat belt.

5 Pt. Harness Installation and Use

6. Close and position harness retainer.
-Snap the harness retainer together (Fig. 6).

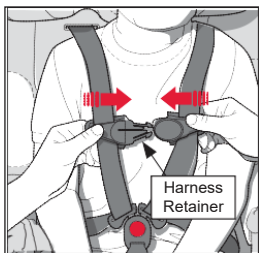

Fig. 6

- Position the harness retainer at arm pit level (Fig. 7).

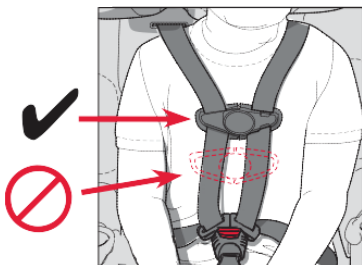

Fig. 7

WARNING!

- To prevent injury from ejection, fasten and tighten the harness system correctly.

Removing Your Child:

1. Open harness retainer (Fig. 8).
-Press on release buttons ① and pull apart ②.

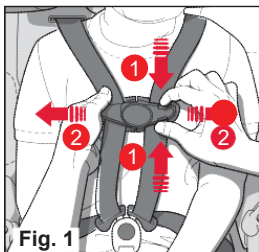

Fig. 1

Fig. 8

2. Open buckle.
-Press red button on buckle to unlock.
3. Remove child.

Selecting a Vehicle Seating Location

WARNING!

- **Never put a booster seat in a vehicle front seating location unless recommended by vehicle owners manual.**

National Highway Traffic Safety Administration (NHTSA) alerts vehicle owners that according to accident statistics, children up to age 12 are safer when properly restrained in the rear seating positions rather than in front seating positions.

Refer to vehicle owners manual for booster seat installation instructions for your vehicle.

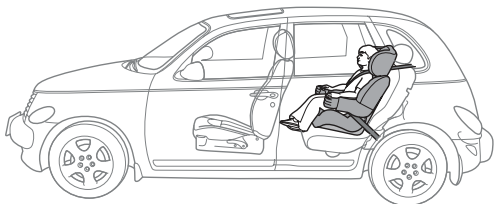

- Use booster seat in a rear vehicle seat location whenever possible.
- Never put a booster seat in a front seat location unless recommended by vehicle owners manual.
- For vehicles with air bags, refer to owners manual for child restraint installation information.

If a vehicle seat location with an air bag must be used, follow the vehicle manufacturer's instructions for child restraint use and move the vehicle seat back as far as possible.

5 Pt. Harness Installation and Use

DO NOT use 5 Pt. Harness system in seat locations with:

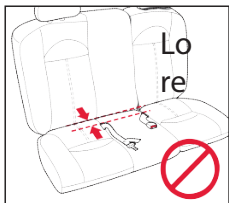

Only vehicle lap belts

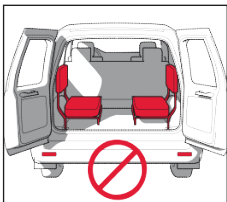

Side facing seats



Rear facing seats

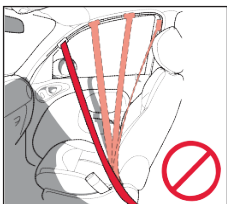

**Motorized vehicle
shoulder belts**

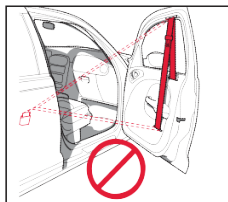

**Vehicle seat belts
mounted to front door**

Installation - LATCH Or Vehicle Seat Belt

Check that Harness System is routed properly for your child's size before installing car seat.

This car seat can be secured to a vehicle using the new LATCH System or a vehicle seat belt. Use either the LATCH system or a vehicle seat belt to secure this car seat but do not use both at the same time.

1. **LATCH Anchorage System:**

LATCH stands for Lower Anchors and Tethers for Children.

Starting with model year 2003, vehicles sold in the U.S. are equipped with LATCH Systems. See "LATCH System" section for more information. Check vehicle owners manual to determine if your vehicle has the LATCH System that may be identified with the symbol as shown in (Fig. 9 or Fig. 10).



Fig. 9

Fig. 10

Some vehicle owners manuals may identify the LATCH System as "ISOFIX." An ISOFIX System can be used in the same way as the LATCH System.

If your vehicle has the LATCH System, the LATCH System should be used whenever possible. When not in use, store lower anchors on back of seat **A** (Fig. 11).

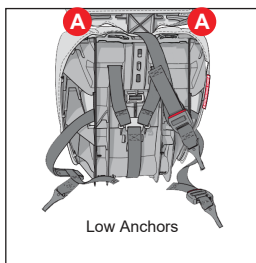

Fig. 11

2. **Vehicle Seat Belt and Top Tether Strap:**

If your vehicle does not have the LATCH System, the car seat **MUST** be secured to the vehicle using a vehicle seat belt and top tether strap as required.

Check vehicle owners manual for seating locations recommended for car seat use and location of top tether anchor.

5 Pt. Harness Installation and Use

3. Top Tether Information:

If a top tether anchor is not available in your vehicle, the car seat MUST be secured with only the vehicle seat belt until a top tether anchor can be installed. Use only if a secure installation can be achieved.

For vehicles without tether anchors, contact vehicle dealer for hardware for your specific vehicle. If tether hardware is not available through vehicle dealer, contact KidsEmbrace™ for assistance.

For those passenger vehicles or buses where top tether anchors are not available, the car seat may be used without the top tether, provided a secure installation can be achieved.

When tether is not in use, store tether behind seat (Fig. 12).

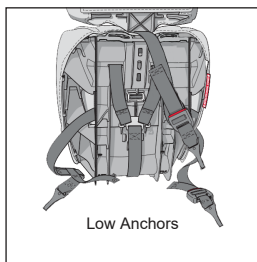

Fig. 12

4. Assistance With Installation:

For assistance with installation or use, contact:

KidsEmbrace, LLC
6711 Odessa Ave
Van Nuys, CA 91406

Or visit us online at: <http://www.KidsEmbrace.com>

Installation With LATCH Anchorage System

LATCH System On This Car Seat:

The LATCH system on the KidsEmbrace™ car seat can be used when using this car seat as a 5 Pt. Harness Car Seat or a Booster Car Seat.

The LATCH System on this car seat consists of a lower anchor belt **1** with lower anchors **2** and a top tether strap with tether hook **3** (Fig. 13).

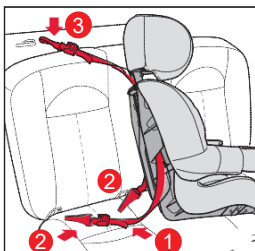

Fig. 13

LATCH System In Vehicles:

The child restraint anchorage system or LATCH System in the vehicle consists of two lower anchors **4** located at the vehicle seat bight **5** and a top tether anchor **6** (Fig. 14).

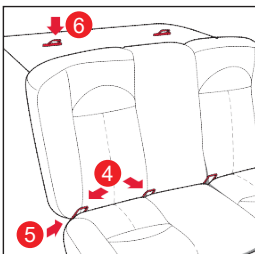

Fig. 14

Refer to vehicle owners manual for seating locations which have the LATCH System.

Lower anchors may not be visible in some vehicles. Lower anchors that are not visible are located below a solid color round dot on the vehicle upholstery or a round dot with a picture of a car seat in the center as shown in (Fig. 15).



Fig. 15

The vehicle manufacturer may provide funnel guides to separate the vehicle seat cushions providing easier access to the lower anchorage. See vehicle owners manual.

 WARNING!

- **LATCH belt MUST stay tightly adjusted around car seat at all times.**
- **Only use the car seat LATCH System in vehicle seating locations designated by the vehicle manufacturer for use with LATCH and that have an anchor spacing of 11 inches (280 mm).**
- **Lower Anchors must be secured to the vehicle LATCH anchors only.**
- **Connection to other vehicle anchors or vehicle components could result in the anchor tearing free in a crash.**
- **Never attach more than one lower anchor connector to a vehicle lower anchor unless recommended by the vehicle owners manual for that vehicle.**
- **For harness use, do not use the lower anchors of the child restraint anchorage system (LATCH system) to attach this child restraint when restraining a child weighing more than 45 lb. (20 kg.) with the internal harnesses of the child restraint. Install with vehicle seat belt.**
- **Secure and tighten LATCH belt then tighten tether.**

5 Pt. Harness Installation and Use

Your car seat is shipped with the LATCH belt routed in the belt path and both lower anchors attached to their storage bars.

1. Remove Lower Anchors by squeezing the retainer spring and unhooking from the storage **A** (Fig 16).

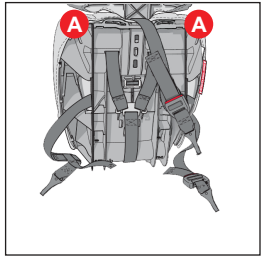

Fig. 16

2. Place car seat forward-facing in a seat location equipped with LATCH anchorage system. (Fig 17).

See your vehicle owners manual for LATCH locations and additional information.

If vehicle seat back is adjustable, adjust into upright position.

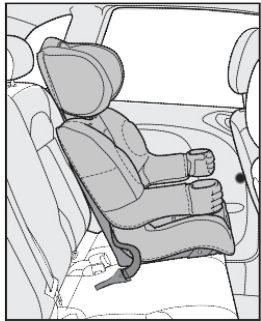

Fig. 17

3. Secure LATCH lower anchor belt.

Place Lower Anchor hook over vehicle lower anchor on each side of the car seat. You should hear a click from the retainer spring (Fig. 18).

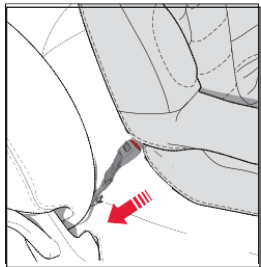

Fig. 18

-Pull out on each lower anchor to be sure it is locked onto vehicle lower anchor.

5 Pt. Harness Installation and Use

4. Tighten LATCH belt (Fig. 19).
-Place knee in seat and push down firmly while pulling on free end with loop to tighten LATCH lower anchor belt.

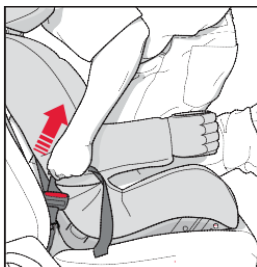

Fig. 19

5. Connect tether hook to the top tether anchor and snugly adjust tether (Fig. 20).

-To adjust, see "Adjusting Top Tether" section.

6. Check for secure installation (Fig. 21).

-With hand on arm rest, push the child restraint forward and back, and from side to side. The LATCH belt MUST stay tightly adjusted and not loosen.

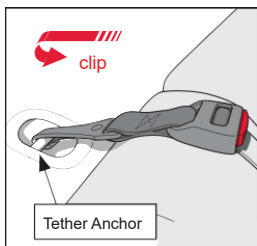

Fig. 20

Note: Movement from front to back should be limited and movement side to side near the belt path should be less than 1 inch is acceptable.



Fig. 21

If the lower anchor belt does not remain tight, do not use this child restraint in this seating location with this LATCH system. Try installing with the vehicle seat belt or use another seating location with LATCH anchor.

Remove LATCH Anchorage System

1. Loosen top tether and remove tether hook from top tether anchor (Fig. 20).

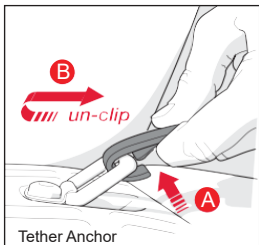

Fig. 20

2. Loosen lower anchor belt (Fig. 21).

- Push down on release button and pull adjuster away from car seat.

Note: Pressing down in center of car seat can make loosening belt easier.

3. Release Lower Anchors by pressing in on the retainer spring and then push in the hook and rotate 90 degrees to pull out.

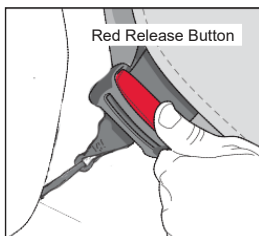

Fig. 21

4. When not in use, store lower anchors on storage bars on back of seat (A) (Fig. 22).

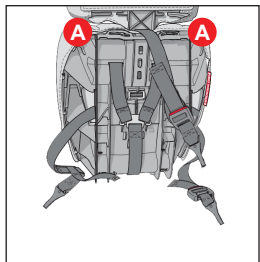

Fig. 22

WARNING!

- LATCH connectors **MUST** be securely fastened when not in use. Failure to do this can cause injury or death.

Installation With Vehicle Seat belt:

WARNING!

- Vehicle seat belt **MUST** stay tightly adjusted around car seat at all times.

1. Determine the type of seat belt installed in the vehicle. Use “Vehicle Seat Belts” section for reference to correctly install.

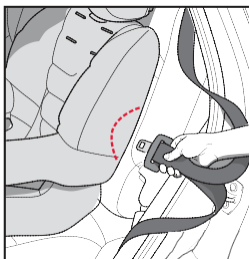

Fig. 23

2. Place car seat forward-facing in the seat location selected.

-If vehicle seat back is adjustable, adjust into upright position.

-Top tether should be used wherever possible. Store tether if not used to install car seat. See “Tether Storage” section.

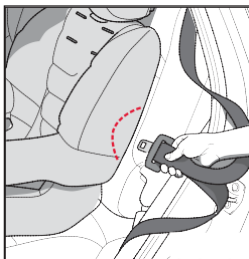

Fig. 24

3. Thread the vehicle lap belt (Fig. 23) or vehicle lap and shoulder belt combination (Fig. 24) through the belt path opening and out the belt path opening on opposite side (Fig. 25).

4. Buckle vehicle seat belt.

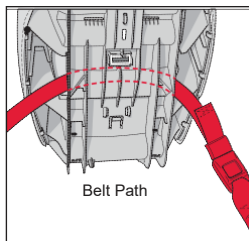

Fig. 25

5 Pt. Harness Installation and Use

5. Tighten the lap belt (Fig. 26).

-Place knee in seat and push down firmly while pulling on the vehicle seat belt to tighten lap belt.

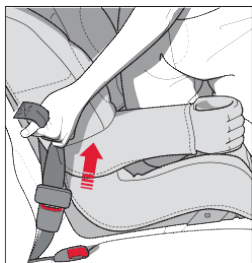

Fig. 26

6. Connect tether hook to the top tether anchor bracket and snugly adjust tether (Fig. 27) see Top Tether use section.

7. Check for secure installation (Fig. 28).

-With hand on arm rest, push the car seat forward and back, and side to side. Vehicle seat belt MUST stay tightly adjusted and not loosen.

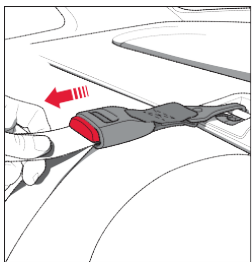

Fig. 27

Note: Movement from front to back should be limited and movement side to side near the belt path should be less than 1 inch is acceptable.

If the seat belt does not remain tight, see "Vehicle Seat Belts" section or move car seat to another seating location.



Fig. 28

Remove Vehicle Seat Belt System

1. Loosen top tether and remove tether hook from top tether anchor, see “Top Tether Use” section. (Fig 29).
2. Unbuckle vehicle seat belt.

Note: Pressing down in center of car seat can make unbuckling vehicle seat belt easier.

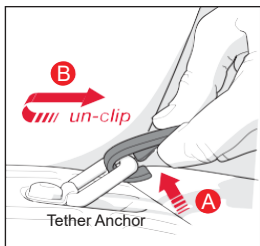

Fig. 29

3. Remove vehicle seat belt from belt path openings.



WARNING!

- LATCH connectors **MUST** be securely fastened when not in use. Failure to do this can cause injury or death.

Securing Child with Booster

Child MUST be at least 4 years old and weigh between 40 and 100 pounds (18 and 45 kg).

WARNING!

- **Use Booster Car Seat with vehicle lap and shoulder belt only with vehicle lap belt under armrests.**
- **Vehicle belts MUST lay flat against child and MUST NOT be twisted.**
- **Never use Booster Car Seat with only a vehicle lap belt. Using a Booster Car Seat with only a lap belt could result in serious injury or death to a child.**
- **For vehicles with an air bag, but without a back seat, refer to your vehicle owners manual.**
- **If child will not keep vehicle shoulder belt properly positioned, DO NOT use this Booster Car Seat. Use a different car seat.**
- **Discontinue use of Booster Car Seat when:**
 - **Child's weight exceeds 100 pounds (45 kg).**
 - **Top of child's ears are above top of headrest. Severe head or neck injuries could result without proper head support.**

When child is over 65 pounds (30 kg) or 49 inches (124 cm) you **MUST** remove the harness and use this child restraint as a booster car seat, see "Removing Harness" section.

WARNING!

- Only use Booster Seat in seating location with lap and shoulder belt.
- Never use Booster Seat in seating location with only a lap belt.
- Never put a Booster Seat in a front vehicle seating location unless recommended by vehicle owners manual.
- Snugly adjust the vehicle lap and shoulder belt around child according to the instructions in the vehicle owner's manual.
 - Vehicle lap belt **MUST** be positioned low on the hips contacting the thighs.
 - Shoulder belt must be properly positioned over shoulder (**NOT** touching child's neck and **NOT** off shoulder).
 - Never use shoulder belt when loose, positioned under child's arm, or behind child.
 - **DO NOT** allow child to slide down in Booster Seat. This could position vehicle lap belt across child's abdomen and shoulder belt over neck or face.



Selecting a Vehicle Seating Location

-Booster Seat:

WARNING!

- **Never put a booster seat in a vehicle front seating location unless recommended by vehicle owners manual.**

National Highway Traffic Safety Administration (NHTSA) alerts vehicle owners that according to accident statistics, children up to age 12 are safer when properly restrained in the rear seating positions rather than in front seating positions.

Refer to vehicle owners manual for booster seat installation instructions for your vehicle.

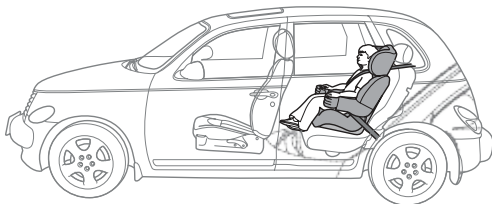

- Use booster seat in a rear vehicle seat location whenever possible.
- Never put a booster seat in a front seat location unless recommended by vehicle owners manual.
- For vehicles with air bags, refer to owners manual for child restraint installation information.

If a front vehicle seat location with an air bag must be used, follow the vehicle manufacturer's instructions for child restraint use and move the vehicle seat back as far as possible.

Booster Seat Installation and Use

DO NOT use Booster system in seat locations with:

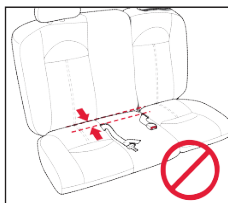

**Vehicle seat belts
forward of seat
bight**

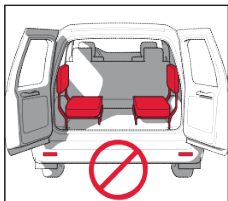

Side facing seats



Rear facing seats

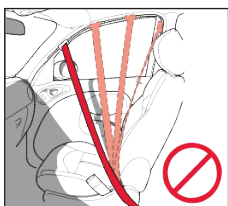

Motorized shoulder belt

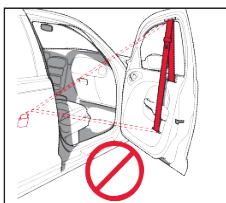

**Vehicle seat belts
mounted to front door**

Securing Booster With LATCH

The LATCH attachment system can be used to secure the booster seat into the vehicle if available. Use of the LATCH attachment system keeps the booster seat secured at all times and assists a child when getting into the booster seat.

- Secure LATCH lower anchor belt and top tether as shown in "Installation With LATCH Anchorage System" section.

If not using LATCH to secure booster, store LATCH Lower Anchor Belt And Top Tether

WARNING!

- Use vehicle lap and shoulder belt only with vehicle lap belt under armrests.

Securing Child with Lap and Shoulder Belt

1. Remove harness system, see "Removing Harness" section.
2. If available - Secure the Booster using the LATCH system, see "Installation with LATCH Anchorage System" section, or place booster forward-facing in a rear seat location which has a vehicle lap and shoulder belt (*Fig. 30*).

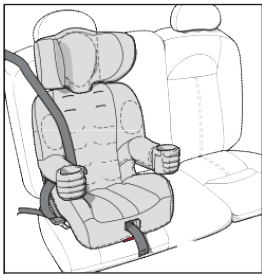

Fig. 30

System" section, or place booster forward-facing in a rear seat location which has a vehicle lap and shoulder belt (*Fig. 30*).

Booster Seat Installation and Use

- If vehicle seat back is adjustable, adjust into most upright position.

DO NOT place the Booster Car Seat in a seating position that has only a lap belt (Fig. 31).

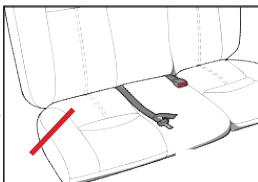

Fig. 31

3. Position child in Booster Car Seat with child's back flat against car seat back (Fig. 32).

4. Place vehicle lap belt on thighs and shoulder belt across child's chest and centered on shoulder (Fig. 33). Buckle vehicle seat belt

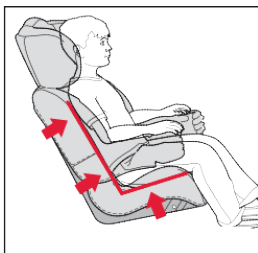

Fig. 32

Note: Lap belt **MUST** be placed under armrests and shoulder belt **MUST** be through shoulder belt guide.

5. Place vehicle shoulder belt in vehicle shoulder belt guide (Fig. 34).



Fig. 33

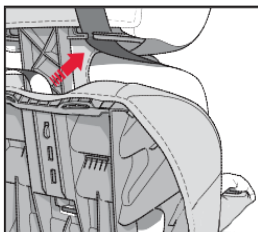

Fig. 34

Booster Seat Installation and Use

6. Adjust headrest so that vehicle shoulder belt guide is above and centered on the child's shoulder (Fig. 35).

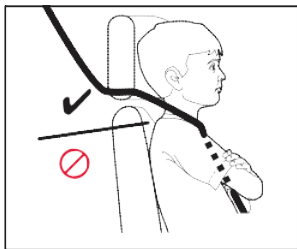

Fig. 35

To Raise or Lower Headrest:

7. On back of seat, locate headrest adjustment button ①, center in opening, press button in and adjust headrest ② up or down into position to properly position shoulder belt (Fig 36).

NOTE: Make sure headrest is locked into position.

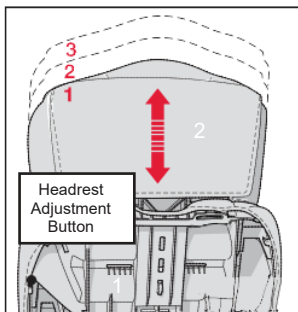

Fig. 36

8. Snugly adjust the lap and shoulder belt according to the instructions in the vehicle owners manual.

- DO NOT place shoulder belt under child's arm or behind child (Figure 37).

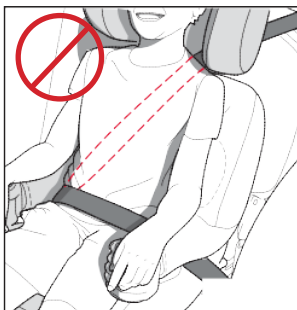

Fig. 37

Booster Seat Installation and Use

9. Check fit of vehicle belts (Fig 38).

-The lap belt must be low and snugly adjusted on hips, contacting the thighs ①.

-The shoulder belt must contact the chest and be centered on the shoulder ②.

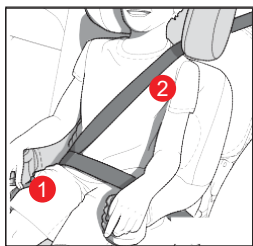

Fig. 38



WARNING!

- **LATCH connectors MUST be securely fastened when not in use. Failure to do this can cause injury or death.**

To Remove Child:

1. Unbuckle vehicle seat belt.
2. Remove child.

To Remove Booster Car Seat When LATCHED:

See "To Remove Car Seat:" section.

Shoulder Harness Adjustment:

To Tighten:

Pull front adjuster strap
(Fig. 39).

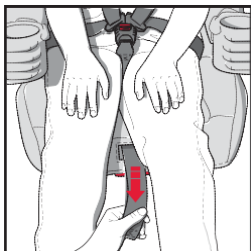

Fig. 39

To Loosen or Lengthen:

- Grasp the harness straps.
- Lift up on the harness adjustment lever (Fig 40).
- Pull out on the harness straps.

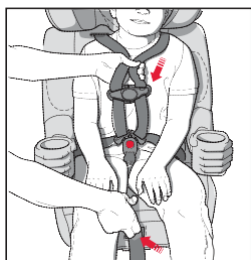

Fig. 40

Changing Shoulder Harness Position

Shoulder harness straps must be through shoulder harness slots closest to and above the child's shoulder (Fig 41). When top shoulder harness slots are below the child's shoulders or the child weighs 65 lbs. (30 kg) and is over 4 years old, convert the car seat to a booster car seat.



Fig. 41

Operation and Adjustment

1. From back of seat, remove sewn loops at ends of shoulder harness straps from Metal Splitter Plate (Fig. 42).

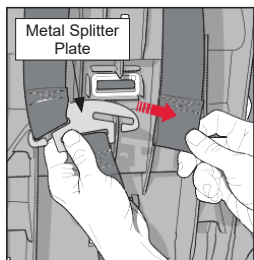

Fig. 42

2. From front of seat, pull shoulder harness straps out of slots in seat back and seat pad.

3. Thread ends of shoulder harness straps through desired shoulder harness slots in seat pad and seat back (Fig 43).

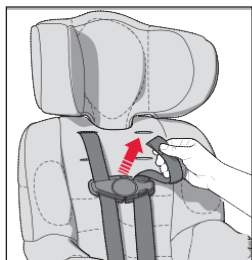

Fig. 43

4. From back of seat, thread sewn loops on shoulder harness straps onto Metal Splitter Plate (Fig 44).

Make sure both sides of shoulder harness straps are placed into slots on Metal Splitter Plate.

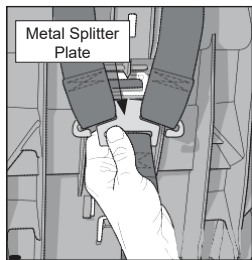
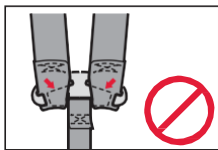

Fig. 44

WARNING!

- Failure to re-attach harness to Metal Splitter Plate correctly can cause serious injury or death.

Removing Harness:

1. From back of seat, unfasten shoulder harness straps from metal splitter plate (**Fig. 1**).

2. Store metal splitter plate under the seat.

3. From front of seat (*Fig. 45*), pull shoulder harness straps through shoulder harness slots **A**.

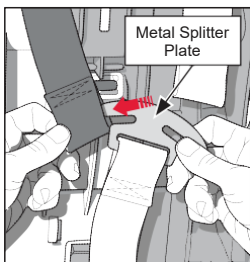

Fig. 45

4. Unthread shoulder harness straps from:

- Harness strap covers **B** (optional), harness retainer **C**, and buckle tongues **D**.

Pull shoulder harness straps out through bottom of seat bottom. **E** Please keep the Energy Absorbing Harness Pads with the harness for future use.

To remove crotch belt with buckle:

5. Turn metal crotch strap anchor sideways and slide out of crotch belt slot(s) in shell.

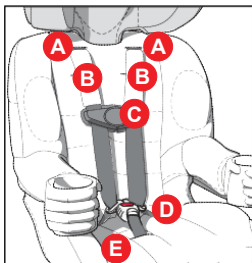

Fig. 46

Changing Crotch Belt Position

Crotch strap MUST be in opening closest to but not under child. Raise seat pad from seat surface, pulling buckle down through pad. Remove crotch belt by turning metal crotch strap anchor sideways and sliding out of crotch belt slot(s) in shell.

To Secure Crotch Strap in Forward Crotch Belt Slot.

1. Turn metal crotch strap anchor sideways and slide all the way through car seat shell in forward crotch belt slot (Fig 47).

- Pull up on belt to make sure it is properly secured.

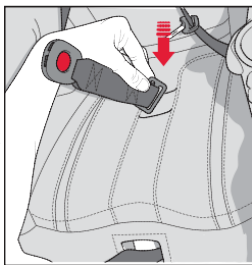

Fig. 47

To Secure Crotch Strap in Rear Crotch Belt Slot.

1. From top of car seat, hold crotch strap so that red release button is facing front of car seat.
2. Turn metal crotch strap anchor sideways and slide into slot closest to seat back.

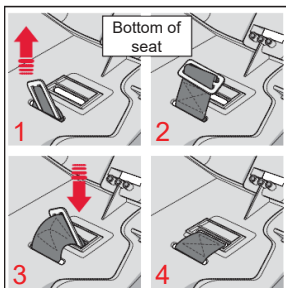

Fig. 48

3. From bottom of car seat, turn metal crotch strap anchor sideways and slide through slot furthest from seat back placing metal anchor flat against top of seat surface in recessed area.

NOTE: Pull up on buckle and check to be sure metal anchor sits flat against top surface of seat.

4. Lower seat pad onto seat and pull buckle up through pad.

Recline Adjustment:

This car seat is equipped with a recline foot to provide additional comfort for your child. The car seat can be used in the reclined or upright position as both a toddler car seat (with harness) and as a booster car seat (without harness).

To Recline Car Seat:

1. If the car seat is secured to the vehicle with LATCH or a vehicle belt, remove the car seat from the vehicle. See: "To Remove Car Seat." section.
2. Grasp the red recline handle and push down, then rotate the recline foot rearward until it locks into the reclined position (Fig. 49).

The car seat is now in the reclined position (Fig. 50).

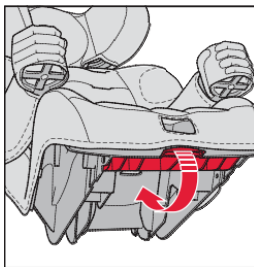

Fig. 49

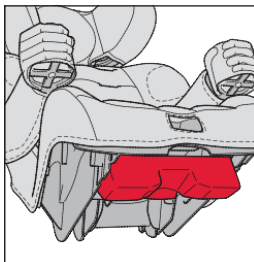

Fig. 50

To Position Car Seat Upright:

1. If the car seat is secured to the vehicle with LATCH or a vehicle belt, remove the car seat from the vehicle. See: "To Remove Car Seat." section.
2. Grasp the red recline handle and pull down, then rotate the recline foot forward until it locks into the upright position (Fig. 51).

The car seat is now in the upright position.

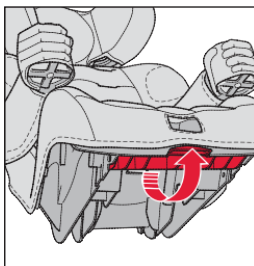

Fig. 51

Installing Harness:

To install shoulder harness straps:

1. Feed sewn loop at end of each shoulder harness strap up through one lap belt slot **A** (Fig. 1). The Energy Absorbing Harness Pads with metal plate should rest against the bottom of the seat.

2. Thread harness straps into buckle tongues **B**, from back to front

3. Thread the harness straps through the harness retainer **C** and harness covers **D**.

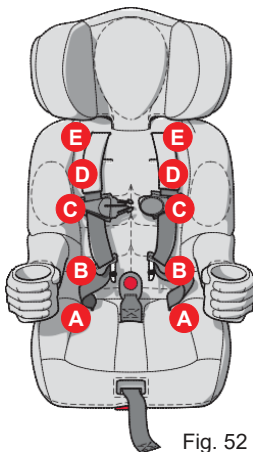

Fig. 52

4. Make sure harness is not twisted.

5. Slide harness ends through the proper shoulder harness slot **E** for your child's size. From back of car seat, pull shoulder harness straps through the back (Fig. 53).

6. Locate the metal splitter plate in the back of the seat.

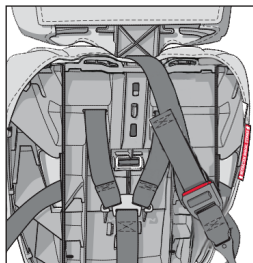

Fig. 53

Operation and Adjustment

5. Pull metal splitter plate out.

6. Thread loops on shoulder harness strap ends onto the metal splitter plate (Fig. 54).

7. Make sure both sides of shoulder harness straps are placed into slots on metal splitter plate (Fig. 55).

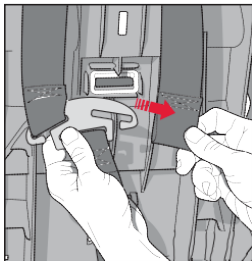

Fig. 54

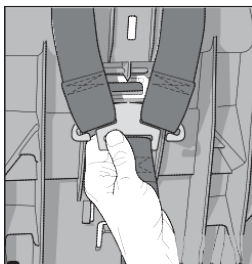
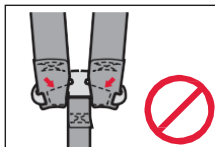

Fig. 55



WARNING!

- Failure to re-attach harness to Metal Splitter Plate correctly can cause serious injury or death.

To Secure Crotch Strap in Forward Crotch Belt Slot.

1. Turn metal crotch strap anchor sideways and slide all the way through car seat shell in forward crotch belt slot (Fig. 56).

- Pull up on belt to make sure it is properly secured.

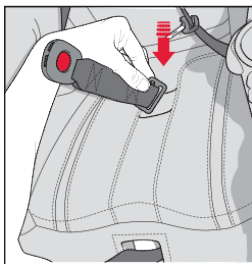

Fig. 56

To Secure Crotch Strap in Rear Crotch Belt Slot.

1. From top of car seat, hold crotch strap so that red release button is facing front of car seat.
2. Turn metal crotch strap anchor sideways and slide into slot closest to seat back.

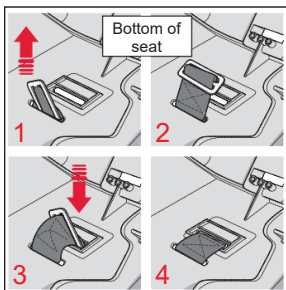

Fig. 57

3. From bottom of car seat, turn metal crotch strap anchor sideways and slide through slot furthest from seat back placing metal anchor flat against top of seat surface in recessed area.

NOT: Pull up on buckle and check to be sure metal anchor sits flat against top surface of seat.

4. Lower seat pad onto seat and pull buckle up through pad.

Top Tether Use:

Most vehicles made after 9/1/99 already have the top tether anchorage hardware for a tether. Refer to your vehicle owners manual. If your vehicle does not have a top tether anchor, see your vehicle dealer.

To Attach Top Tether:

Place opening in tether hook over top tether anchorage, push down and pull back to attach hook to vehicle (Fig. 58).

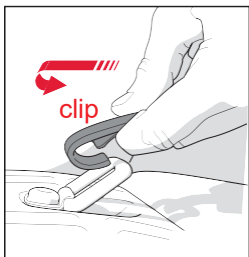

Fig. 58

To Tighten Tether Strap:

-Pull on free end of tether strap.

To Remove Top Tether:

-Push release button in and move adjuster away from car seat

-Push up on retainer spring **1** and unhook tether hook from top tether anchor **2**.

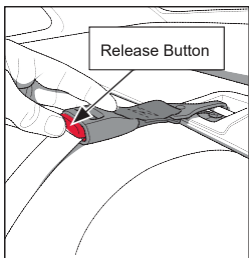

Fig. 59

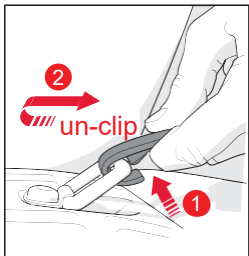

Fig. 60

Additional Information

Certification:

This car seat meets or exceeds all applicable requirements of Federal Motor Vehicle Safety Standard 213 for use in motor vehicles and aircraft.

Aircraft Use:

5 Pt. Harness Car Seat (With Harness):

Car Seat with harness system IS certified for use on aircraft.

- Use this car seat only on forward-facing aircraft seats and in a position where the lap belt can be tightened securely.
- Install car seat on aircraft the same way it is installed in a vehicle with a vehicle lap belt. Tether use is not required as a tether anchor is not available.
- Use this car seat only with FAA certified equipment. Contact the airline prior to taking car seat on board in order to comply with their specific regulations.

Booster Car Seat (Without Harness):

This Booster Seat is NOT certified for use on aircraft.

Car seat without harness system is NOT certified for use on aircraft because there is no shoulder belt available on aircraft.

Warm Weather Use:

Booster seat parts can get very hot in the sun or warm weather.

To avoid burns, always check booster seat before putting child in booster seat.

Vehicle Seat Protection:

Protect vehicle seat. Use a thin booster seat mat, thin towel or thin blanket under booster seat.

Car Seat Useful Life:

DO NOT use after date on bottom of booster seat.

Vehicle Seat Belts

5 Pt. Harness System

~~22 to 65 lbs. (10 to 30 kg)~~

Not all vehicle seat belts will work with this booster seat. You must determine if your vehicle seat belts are compatible with this booster seat.

ELR - Emergency Locking Retractor Belts

Definition:

1. These belts only lock in a sudden stop or crash. To see if you have this type of belt, pull the belt all the way, let it return part way, then pull on it again. If it moves out freely, it is an ELR belt and the car seat could work loose during normal driving. Refer to your vehicle owner manual for information on how to secure a car seat.

Use:

ELR lap and shoulder belts either require a locking clip or cannot be used with any car seat. Note: You may use an ELR lap and shoulder belt when using this child restraint as a belt-positioning booster; no locking clip is required.

ELR lap-only belts must be replaced with a manual belt; contact your vehicle dealer. A locking clip will not correct this problem.

Automatic/Passive Vehicle Seat Belts

2. Do not use any car seat with motorized seat belts or with seat belts mounted to the vehicle front door.

Check your vehicle owner manual or contact your vehicle dealer to see if there are alternatives for securing a car seat in this position.

Vehicle Belt Too Short

3. Contact your vehicle dealer for a seat belt extender.

Vehicle Seat Belts

Belts in center of the door or side panel **A or middle of the vehicle seat bottom cushion **B**.**

4. You must move the car seat to another seating location.

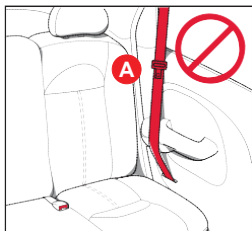

Fig. 61

5. Manual lap belts are common in the center rear seat and in some cases can allow the car seat to loosen during normal use. After tightening the vehicle lap belt securely, push the car seat forward and to both sides (Fig. 63). If no loosening occurs, your child restraint can be used as installed.

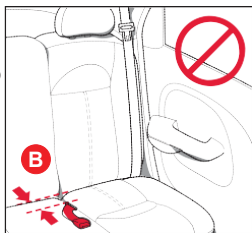

Fig. 62



Fig. 63

Vehicle Seat Belts

Manual Belts -

If lap belt loosens, try the following:

- Unfasten seat belt.
- Turn adjustable latch plate or adjustable buckle over and rebuckle (Fig. 2).
- Tighten seat belt around car seat.
- Refasten the vehicle lap belt. The release button should face out after twisting so that it is easy to reach in an emergency.

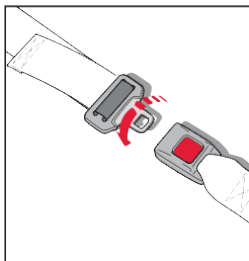

Fig. 64

Check if the car seat is secure.

- If the vehicle lap belt continues to loosen, the car seat must be moved to another location in the vehicle. A locking clip will not correct this problem; see your vehicle owners manual for information on securing a car seat.

Lap and Shoulder Belt with Free Sliding Latch Plate

6. A continuous lap and shoulder belt on which the buckle latch plate slides freely. This type of vehicle seat belt may require the use of a locking clip. See "Locking Clip" section.



WARNING!

- Failure to check and adjust the manual lap belt as described above can result in serious injury or death.

Vehicle Seat Belts

Booster Car Seat Without Harness System: 40 to 100 lbs. (14 to 45 kg).

1. ELR - Emergency Locking Retractor Belts

Definition:

These belts only lock in a sudden stop or crash. To see if you have this type of belt, pull the belt all the way out, let it return part way, then pull on it again. If it moves freely, it is an ELR belt.

Use:

ELR lap and shoulder belts can be used with Booster Seats.

2. Automatic /Passive Vehicle Seat Belts

Do not use any booster seat with motorized seat belts or with seat belts mounted to the vehicle front door.

Check your vehicle owners manual or contact your vehicle dealer to see if there are alternatives for securing a booster seat.

3. Belts in center of the door or side panel **A** or middle of the vehicle seat bottom cushion **B**.

These types of vehicle seat typically work with a Booster Seat.

Check for proper vehicle belt fit on child.

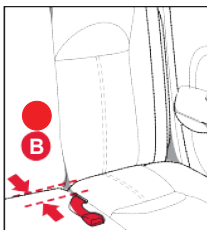
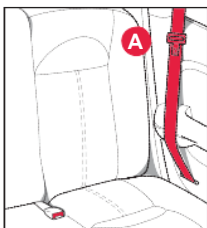

Locking Clip Use:

A locking clip is designed for use with vehicle lap and shoulder belts with free sliding latch plates to lock the lap belt in position. A locking clip will not fix all types of seat belt problems. If you need a locking clip, please call 1-866-947-3287 and KidsEmbrace will ship you a locking clip.

1. Thread both vehicle lap and shoulder belts through the car seat belt path opening. Buckle vehicle seat belt. Tighten vehicle seat belt around car seat by pulling up on vehicle shoulder belt until all slack is out and vehicle lap belt is tight.

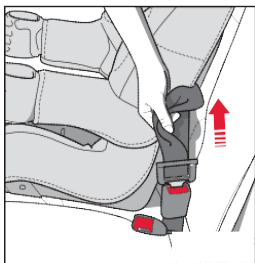

Fig. 65

2. Place knee in seat while pulling to tighten vehicle seat belt. While pulling shoulder belt tight, grasp both vehicle belts together just behind the buckle plate and unbuckle.

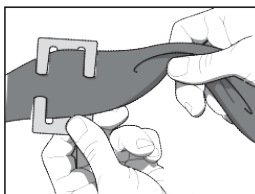

Fig. 66

Note: If the latch plate ends up behind the child restraint, grasp the belts outside of the child restraint, as close to the latch plate as possible (Fig. 65).

3. While holding both vehicle belts together, thread both portions of the vehicle belt onto the locking clip (Fig. 66).

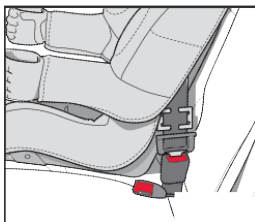

Fig. 67

Note: Slide locking clip onto seat belt as close to the latch plate as possible (maximum 1 inch (15 mm) away from latch plate).

4. Press down on car seat and rebuckle vehicle belt. Vehicle lap belt portion should now be tight (Fig. 67).

If not, remove locking clip and repeat all steps.

Harness Removal:

See "Removing Harness:" section

Seat Pad Removal:

1. Unhook (4) elastic straps from tabs on the seat bottom (Fig. 68).
2. Unhook (2) elastic straps from tabs on the seat back (Fig. 69).

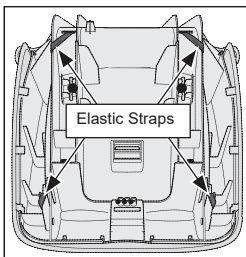

Fig. 68

3. Unhook all pad fasteners along the back and bottom edge of the pad from the seat shell.
4. Pull out on bottom edge of pad at the front of the seat to release (2) push-in fasteners.

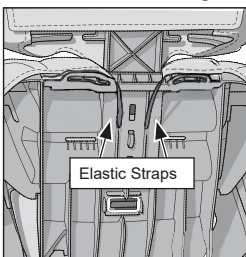

Fig. 69

5. Grasp edge of pad under armrest on one side of seat and pull down and out to release the fabric hook and loop fasteners under the armrest and on the side of the seat. Repeat on the other armrest (Fig. 70).
6. Lift the seat pad off of the seat shell.

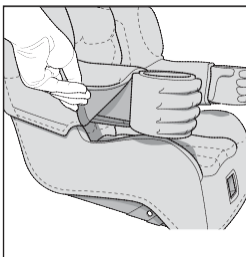

Fig. 70

Headrest Pad Removal:

From the back of the seat, grasp the bottom edge of the back of the headrest and pull up to release the fabric hook and loop fasteners.

From the front of the seat, grasp the front of the two sides of the headrest pad and pull forward to remove headrest pad.

Cleaning:

Seat Pad: Machine wash separately in cold water - delicate cycle. No bleach. Drip dry.

Note: Secure fabric hook and loop fasteners on armrests and sides of pad together before washing and drying pad.

Headrest Pad: Surface clean with a cool damp cloth with mild soap. Drip Dry. **DO NOT** machine wash.

DO NOT use bleach or other harsh cleaners.

Seat Pad Attachment:

1. Place the seat pad on the seat shell. Thread (4) elastic loops through the holes they were removed from in the seat bottom and hook on tabs under seat.

Wrap the arms of the seat pad around the armrests

2. on the seat shell and press the fabric hook and loop fasteners together under the arm and along the seat side.

3. Attach (2) push-in fasteners on front, bottom edge of seat pad to front, bottom edge of seat shell.

4. Hook all seat shell to seat pad fasteners along the back and bottom edge of the seat pad to the seat shell.

5. Hook (2) elastic straps at the top of the seat back on the seat pad to tabs on seat back.

Seat pad Attachment is complete.

Headrest Pad Attachment:

1. Place each side of the headrest pad around each side of the headrest and pull back onto the headrest until the face on the headrest pad is against the back of the inside of the headrest.

2. Insert the neck of headrest between the seat pad and seat shell.

3. Push the fabric hook and loop fasteners on the back of the headrest together.

Headrest Pad Attachment is complete.

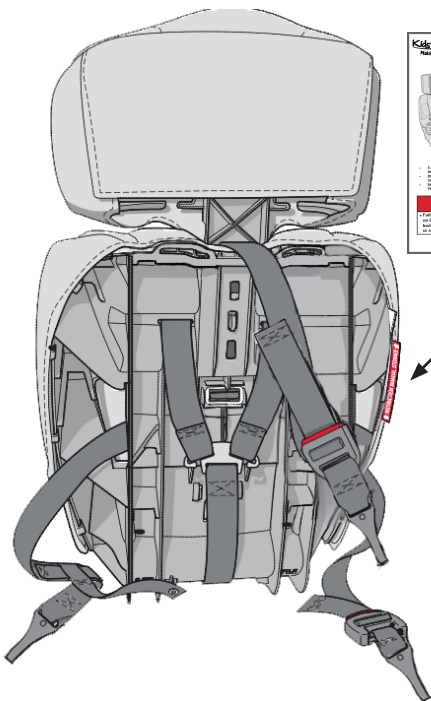

KidsEmbrace
Making Safety Fun

CHILD REQUIREMENTS
 Lowest Weight: 22 lbs (10 kg) (12 months)
 Highest Weight: 50 lbs (23 kg) (5 years)

Child Requiring
 Highest Weight: 40 lbs (18 kg) (5-6 years)

**COMBINATION
 HARNESSES TO
 BOOSTER
 CAR SEAT**

- U.S. Importer: Car Seat #8703 is certified for use in Motor Vehicles and Aircraft.
- Booster Car Seat #8704 is certified for use in Motor Vehicles, not in Aircraft.
- Model or version of booster requirements of Federal Motor Vehicle Safety Standard 213.

WARNING!

- Failure to follow the warnings on Booster Seat Models and in the Instruction Manual can result in death or serious injury to your child.

Keep this instruction manual for future use.
 Store under Trim Cover behind the left
 Armrest.

KidsEmbrace®
 Making Safety Fun

KidsEmbrace, LLC
 6711 Odessa Ave
 Van Nuys, CA 91406-5747

www.KidsEmbrace.com

Questions or comments?
 Call: 1-866-947-3287