

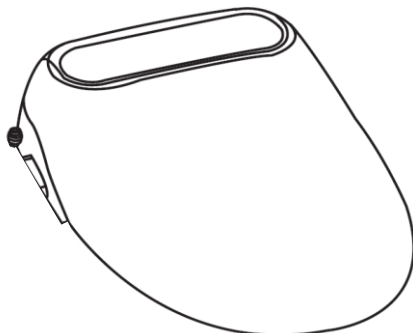

Intelligently Clean, and that's the Bottom Line!

Remote Control User Manual

Clean Comfort Hygiene

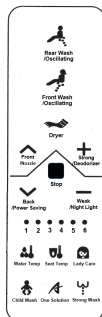



Intelligently Clean, and that's the Bottom Line!

Table of Contents

Page Description	Page Number
Safety Precautions	2
Product Overview	4
Description of parts	6
Operation	7
Installation Guide	12
Maintenance	16
Trouble Shooting	17
Technical Specifications	18
Warranty	19
User Information	20

Safety Precautions

Read all instructions before use.

Save these instructions for future reference.

Warning

May result in death or injury

Caution

May result in death or injury



'Do Not' Disassemble, attempt to repair or alter the Washloo.

Any alterations should be carried out by a qualified technician

Disassembly may result in death or injury.



'Do Not' fully submerge the Washloo into water.

'Do not' use the product in locations exposed to excessive moisture and do not splash water onto the product



'Do Not' touch the plug with wet hands.

This may cause a high risk of an electric shock.



This Washloo is equipped with a cord incorporating an earth wire and an earthed plug.

The plug must be inserted into a power outlet that has been correctly installed



Before connecting the Washloo to the power supply, please ensure the water supply is connected first.

Washloos require a power supply of 220-240V

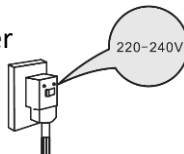

'Do Not' loosen the plug connecting wires.

Ensure the power cable is not damaged or excessively bent prior to use.

Exposed wires may result in an electric shock



Safety Precautions



'Do Not' stand on the Washloo lid or seat.

Any damage found through misuse or standing on the Washloo will not be covered under warranty.



'Do Not' force the Washloo cover or seat downwards or upwards.

This will damage the 'soft closing' mechanism or the physical product. Any damage through misuse will not be covered under warranty.



'Do Not' stretch or bend the plastic water pipes supplying the Washloo.

This may result in leaks within the water supply and potentially damage the Washloo.

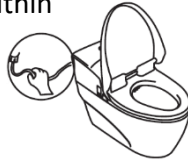

'Do Not' install or leave the remote control near water.

'Do Not' submerge the remote control in water as this will damage the internal circuit boards.



'Do Not' expose the Washloo to below freezing conditions.

The plastic water pipe supplying the Washloo and also the internal water system may get damaged, later resulting in leaks.



For children and seniors who have difficulties with adjusting temperature.

Users with sensitive skin or impaired heat sensitivity should set the temperature of the wash spray, air dryer and seat to 'low' or 'off'.



'Do Not' place an electric heater near the Washloo.

'Do Not' dispose of any burning materials such as cigarettes in the toilet. This may result in fire or product deformation.



'Do Not' place any containers filled with water, medicines, food, metallic objects or flammable materials on top of the Washloo. If foreign objects enter the product, this may result in electric shock or fire.

Product Overview

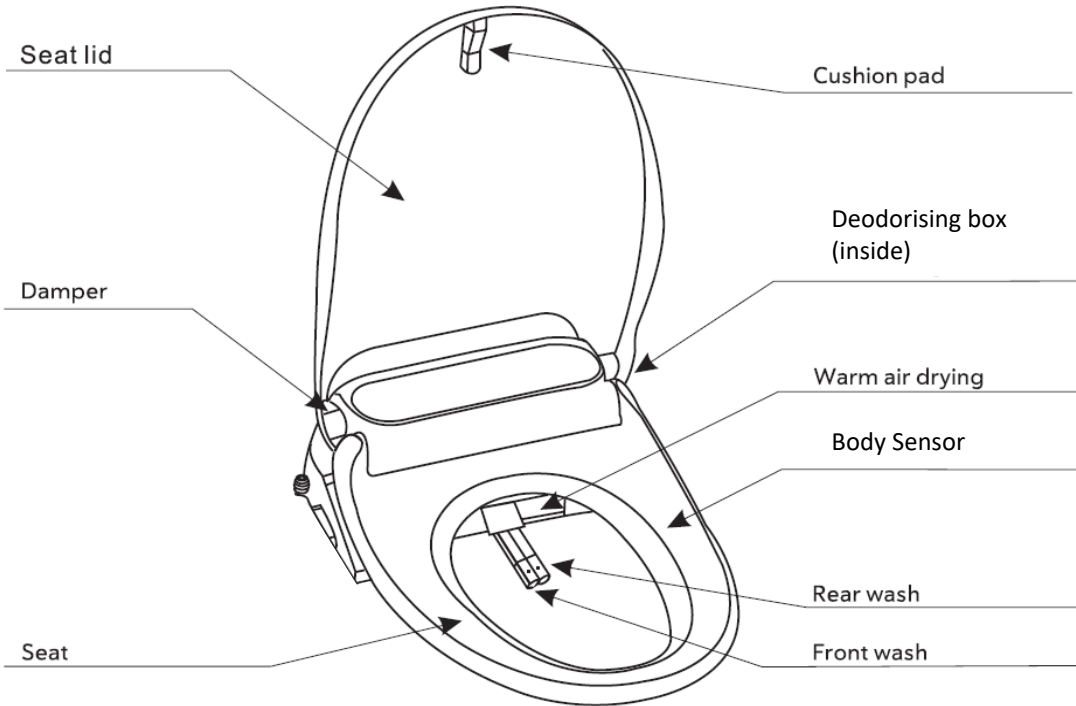

Fitting Kit – All Models

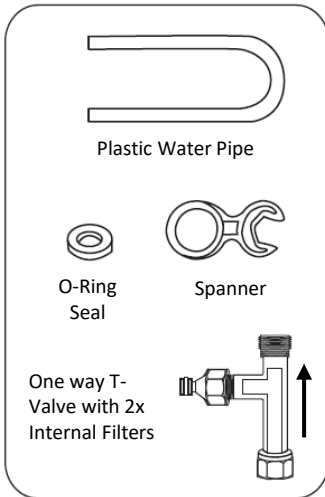

Water Pipe Connecting Accessories

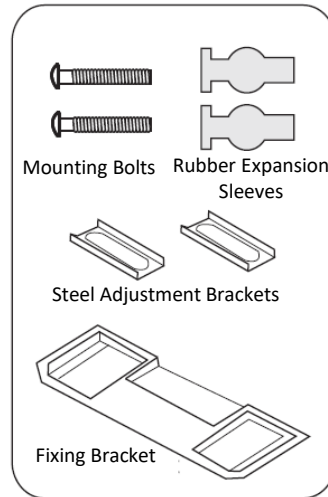

Washloo Attachment Accessories

Note : The above illustration is an example only, your version may vary

Product Overview - Remote Control Models

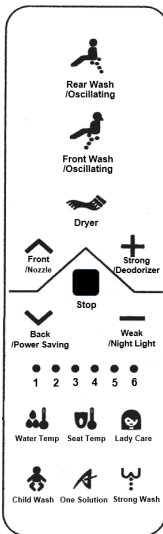
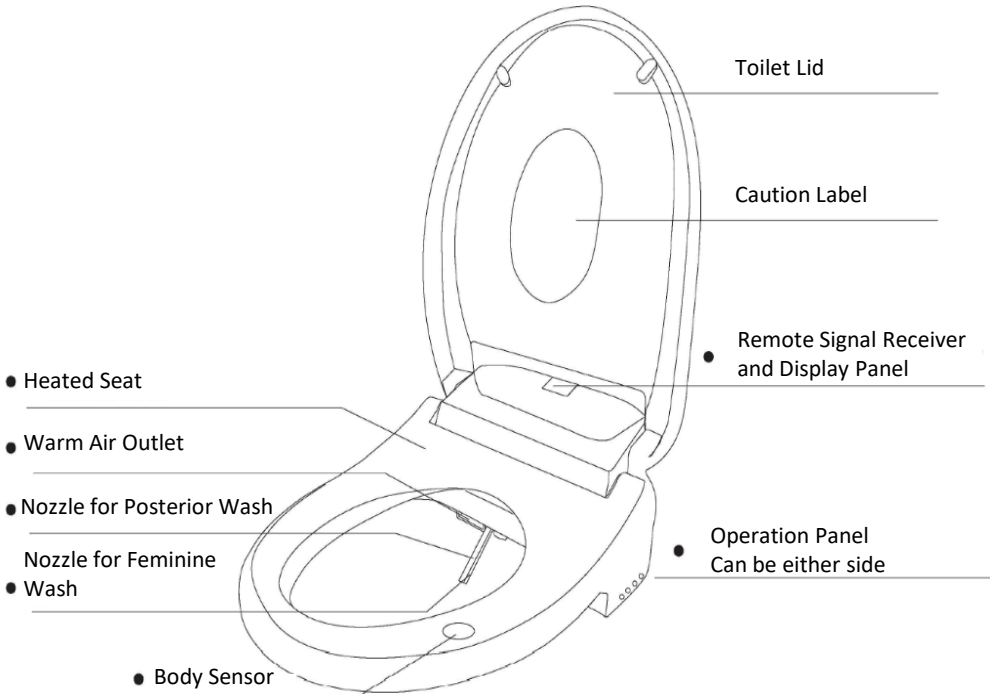

Remote Control

Indicator Panel – Washloo Ultra DR/VR and Omega

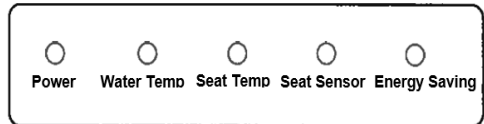

LED Indicator Panel – Washloo Finesse & Finesse Square Only

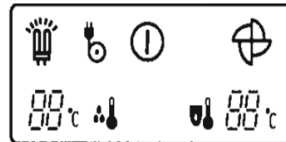

Operation Panel for All Models when Remote Control can't be used. Can be either side.

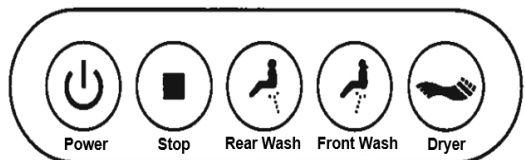

Note : The above illustration is an example only, your version may vary

Description of Parts

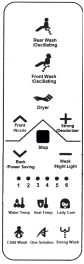

Remote Control

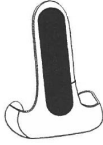

Remote Control Holder

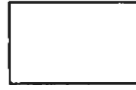

Double Sided Sticky Tape



AAA Batteries

Remote Control Holder to Wall Installation

- Clean Area prior to installation of Remote Control Holder.
- Press the tape down firmly and evenly and place on wall. Leave for 15 minutes prior to inserting the remote control

Remote Control Holder



Install Tape on Backside of Remote Control Holder

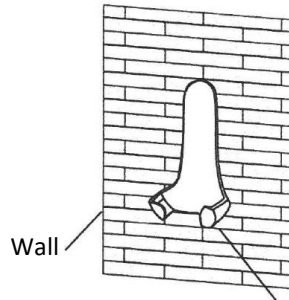

Stick Remote Control Holder onto the Wall

Battery Replacement

Remove backing cover of remote control by sliding downwards.
Renew batteries (AAA Batteries or insert for first use).
Ensure seal cover and batteries are correctly positioned.

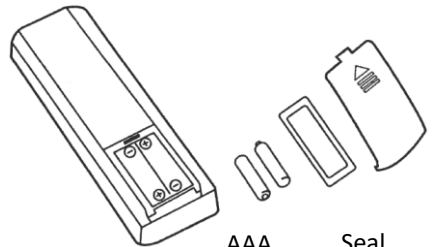

Remote AAA Batteries Seal Cover

Note : The above illustration is an example only, your version may vary

Operation

Rear Wash / Oscillating

When you are seated and press this button, this activates the posterior wash. The nozzle comes out and sprays water on the users posterior area. Press this button again and the nozzle will move forwards and backwards.

Front Wash / Oscillating

When you are seated and press this button, this activates the feminine wash. The nozzle comes out and sprays water on the feminine area. Press this button again and the nozzle will move forwards and backwards.

Dryer

Press this button to use the warm air drying function (when warm air dryer is in operation the deodorisation function will be turned off).

Nozzle position

Adjust nozzle position using forward or backwards button according to your preference and convenience during washing. Please note that during the 'oscillation motion' the adjustment of the nozzle will not be possible.

Water Temp

Press 'Water Temp' button to adjust the water temperature to desired level. There are 4 temperature levels indicated by the numbered lights on the remote control. LOW 33°C (number 1), MEDIUM 36°C (number 2), HIGH 39°C (number 3) and OFF (no light/numbers).

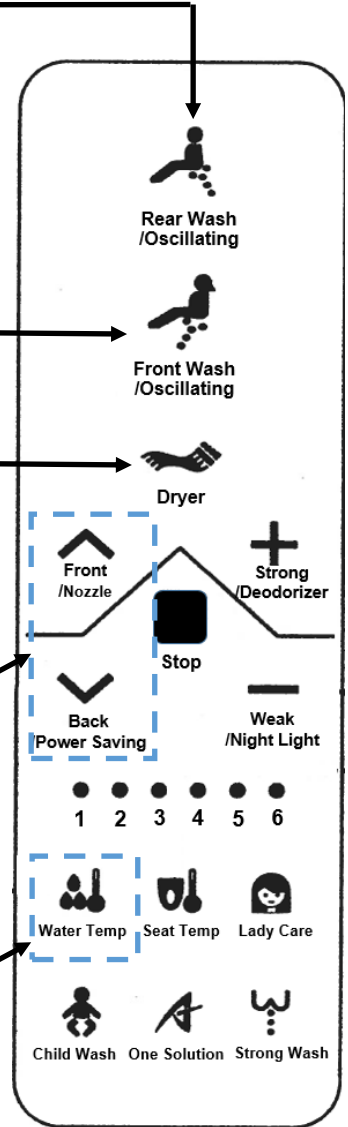

Operation

Strong / Deodoriser (Water Pressure)

While cleansing function is operating, press the 'Strong/Deodorizer' to increase pressure and 'Weak/Nightlight' to decrease pressure. There are three pressure levels: LOW , MED and HIGH. When not seated, the deodoriser button will turn on the deodorisation mode for 2 minutes. Number 2 light will flash on the remote when on.

Stop

All currently operating functions will stop by pressing this button. Press and hold this button for 3 seconds and 'Standby Mode' will be activated.

Power Saving

By pressing the 'Power Saving' button, the bidet will automatically enter the Power Save mode. Number 3 Light on the remote control will flash in order to notify the user of the 'Power Saving' setting selected.

Seat Temp

Use this button to control the seat temperature. There are 4 temperature levels indicated by the numbered lights on the remote control. LOW 33°C (Number 4), MEDIUM 36°C (number 5), HIGH 39°C (number 6) and OFF (no light/numbers). After 10 minutes of inactive use, the temperature of the seat will be lowered and maintained at 35°C, in preparation for the next occupant.

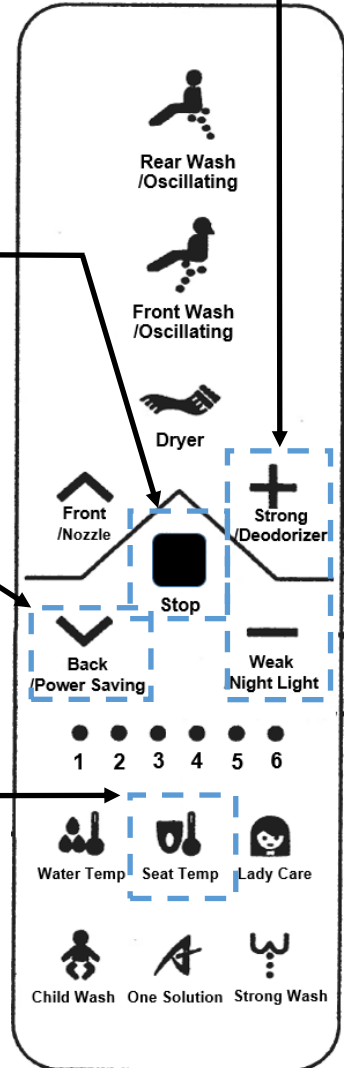

Operation

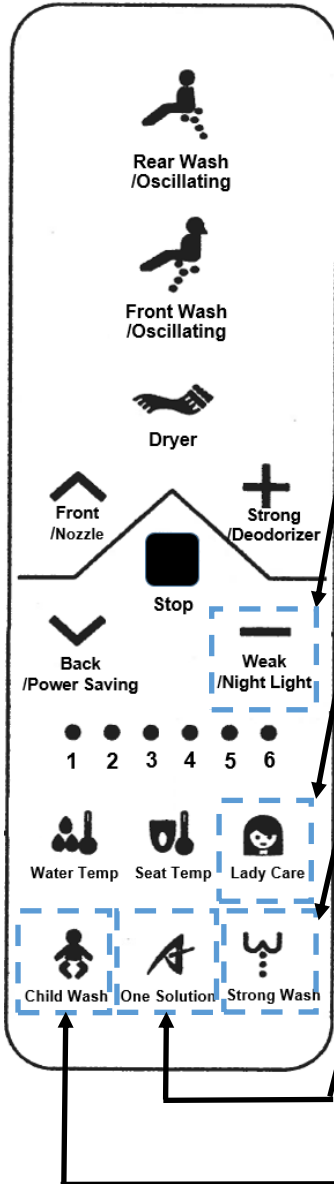

Night Light

Press this button to operate the light on and off function. 'Number 4' light on the remote control will flash when the button is pressed and held, indicating the light will be switched on/off.

Lady Care

Front wash will automatically be selected. Water temp will be set to its highest - HIGH 39°C (number 3) and water pressure is set to MEDIUM 36°C (number 2). The cleaning position is set to default and the cleaning cycle will be automatically set to 2 minutes.

Strong Wash

When you are seated and press this button it activates the 'Strong Wash' function, which uses an intensive water pulsation to help remove defecation. This will automatically set the water pressure to its maximum setting.

One Solution

When you are seated and press this button, this activates the process below;

1. Rear Wash (40 seconds)
2. Oscillating Wash (30 seconds)
3. Warm Air Dryer (2 minutes)

Child Wash

This function is designed for children. Pressing this button activates the below process;

1. Front wash for 30 seconds
- The water pressure is set to minimum and water temperature is set to MEDIUM 36°C (number 2).

Operation

Front Wash / Oscillating

When you are seated and press this button, this activates the feminine wash. The nozzle comes out and sprays water on the feminine area. Press this button again and the nozzle will move forwards and backwards.



Rear Wash / Oscillating

When you are seated and press this button, this activates the posterior wash. The nozzle comes out and sprays water on the user's posterior area. Press this button again and the nozzle will move forwards and backwards.

Water Temp

Press 'Water Temp' button to adjust the water temperature to desired level. There are 4 temperature levels indicated by the numbered lights on the remote control. LOW 33°C (number 1), MEDIUM 36°C (number 2), HIGH 39°C (number 3) and OFF (no light/numbers).

Strong / Deodoriser (Water Pressure)

While the cleansing function is operating, press the  'Strong/Deodoriser' to increase pressure and  'Weak/Nightlight' to decrease pressure. There are three pressure levels: LOW, MED and HIGH. When not seated, the deodoriser button will turn on the deodorisation mode for 2 minutes. Number 2 light will flash on the remote when it's on.

Dryer

Press this button to use the warm air drying function (when warm air dryer is in operation the deodorization function will be turned off).

Dryer Temp

Dryer Temperature can be adjusted using the + and – symbols via the remote control. There are 4 settings indicated by lights 1 to 6.

Night Light

Press this button to operate the light on and off function. 'Number 4' light on the remote control will flash when the button is pressed and held, indicating the light will be switched on/off.

Nozzle position

Adjust nozzle position using forward or backwards button according to your preference and convenience during washing. Please note that during the 'oscillation motion' the adjustment of the nozzle will not be possible.

Operation

Seat Temp

Use this button to control the seat temperature. There are 4 temperature levels indicated by the numbered lights on the remote control.

LOW 33°C (Number 4), MEDIUM 36°C (number 5), HIGH 39°C (number 6) and OFF (no light/numbers).

After 10 minutes of inactive use, the temperature of the seat will be lowered and maintained at 35°C, in preparation for the next occupant.

Child Wash

This function is designed for children. Pressing this button activates the below process;

1. Front Wash 30 seconds

The water pressure is set to minimum and water temperature is set to MEDIUM 36°C (number 5).

One Solution

When you are seated and press this button, this activates the below process;

1. Rear Wash (40 seconds)

2. Oscillating Wash (30 seconds)

3. Warm Air Dryer(2 minutes)

Strong Wash

When you are seated and press this button it activates the *Strong Wash* function, which uses an intensive water pulsation to help remove stubborn defecation. This will automatically set the water pressure to its maximum setting.

Stop

All currently operating functions will stop by pressing this button. Press and hold this button for 3 seconds and Standby Mode will be activated.

Power Saving

By pressing the *Power Saving* button, the bidet will automatically enter the Power Save mode. Number 3 Light on the remote control will flash in order to notify the user of the *Power Saving* setting selected.

Lady Care

Front wash will automatically be selected. Water temp will be set to its highest - HIGH 39°C (number 3) and water pressure is set to MEDIUM 36°C (number 2). The cleaning position is set to default and the cleaning cycle will be automatically set to 2 minutes.

Installation Guide

Installation Environment

1. Prior to installation, ensure the area for the Washloo is clear and the correct model has been selected for your pan (please see online fitting/measuring guide).
2. Washloos' requires water pressure between 0.06Mpa (flow)- 0.75Mpa (Static).
3. Do not use tank fed water, industrial water or grey water for the supply as this may cause skin damage or disease. This may also block the filters located within the T-Piece quickly (Hard Water Areas).
4. Use the supplied T-Valve/Filter to ensure the Washloo is correctly protected against contaminated/hard water. In hard water areas it is advisable to use an inline water softener.
5. 'Do Not' connect the Washloo to the power supply before the installation is complete.

Installation of the T-Valve/Filter

1. Turn off water supply to your existing toilet to avoid any leaks prior to installation (turn your nearest 'Stop Tap' off). Disconnect water supply to the cistern.
2. Connect T-Valve/Filter between the water supply to your existing cistern as shown below.
3. Reconnect the water supply to your cistern now with the T-Valve/Filter installed in line.

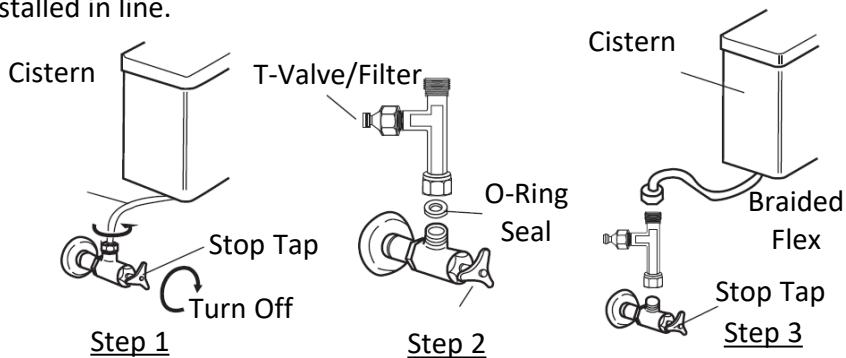

Note : The above illustration is an example only, your version may vary

Installation Guide

Removal of Current Toilet Seat

1. Loosen nuts and attachment bolts holding original toilet seat on.
2. Remove original toilet seat and all fasteners

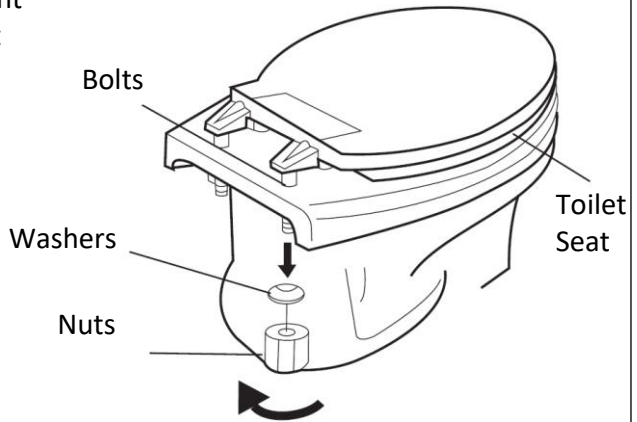

Installation of Fixing Bracket

1. Place Rubber Expansion Sleeves into the attachment holes on your existing toilet.
2. Place the Fixing Bracket on over the installation holes.
3. Place the Steel Adjustment Brackets into the Fixing Bracket as shown.
4. Install the Mounting bolts and tighten down to ensure the 'Fixing Bracket' is in the correct position.

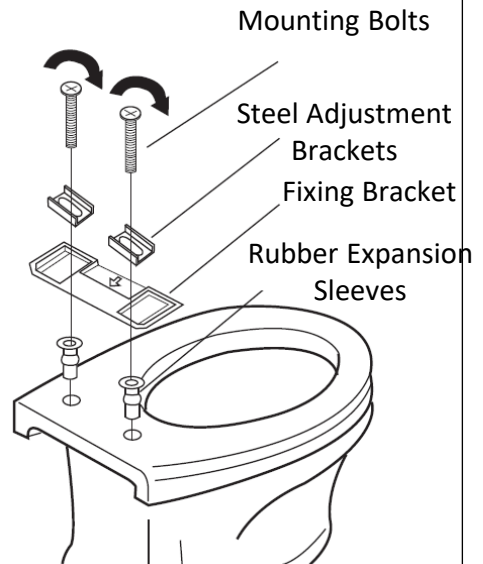

*The Fixing Bracket can be adjusted between 130-170mm to allow adjustment of the Washloo.

Installation Guide

Installation of Washloo Seat

Installing the Washloo Seat

1. Place the Washloo in front of the Fixing Bracket. Using the release button on the lower righthand side allow the locating chamfer on the unit to slide backwards onto the fixing bracket.
2. Push the Washloo back onto the Fixing Bracket in a sliding motion.
3. Ensure the Fixing Bracket does not move and misalign the Washloo.

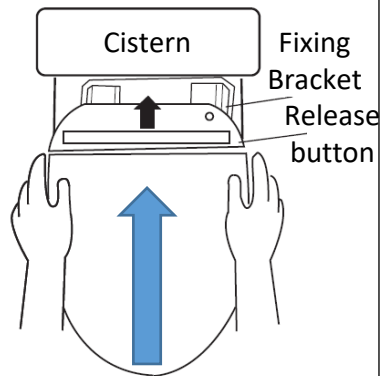

Installation of Water Pipe Fixtures

Installing the Water Feed Accessories

1. Push the Plastic Water Pipe into the compression/push fitting on the T Valve/Filter
2. Push the Plastic Water Pipe into the compression/push fitting on the Washloo.

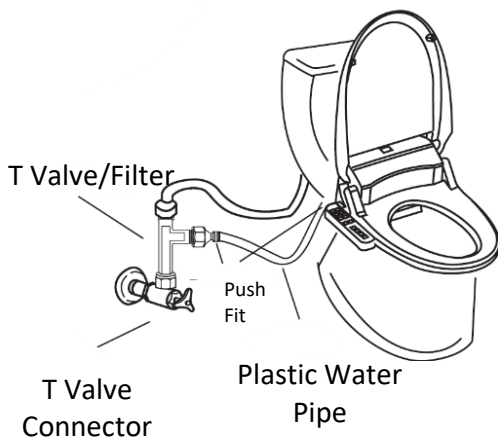

Installation Guide

Preparation for water supply and test for operation.

1. Insert the electric plug into the designated socket/fused spur as recommended by a qualified electrician.
2. When switched on – all lights on the unit will be illuminated. The Washloo will now prime the water system for around 10 seconds and finally the nozzle will extend out whilst performing a cleaning/first use test function.
3. After the first use test cycle – all lights will now turn off and a buzzer sound will notify the user that the full cycle is now complete.
4. Now press the 'Power On' button on the toilet and/or remote control to set the toilet to the 'Standby' setting.
5. Please note – Set the water temperature, water pressure and seat temperature accordingly before use (We recommend you to set to a low temperature/pressure for first use to avoid sensitivity until you are familiar with the Washloo seat).
6. Please follow all instructions within this manual when operating all of the additional functions.



Maintenance

Cleaning and Maintenance; Nozzle Cleaning.

1. To Extend the Nozzles out to the default cleaning position, Press the 'Front / Nozzle' button on the remote control.
2. Pressing the 'Front / Nozzle' button a second time will swap to the second Nozzle.
3. Clean both the nozzles with a brush and ensure they are clear and flowing freely removing if necessary.
4. To replace the nozzles (spare nozzles included) hold the tip of the nozzle and twist anti clockwise.
5. Replacing the tip – insert the replacement nozzle and twist clockwise.

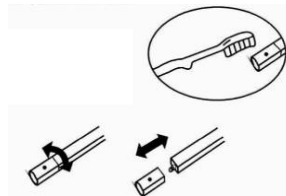

Cleaning and Maintenance; Filter Removal

NOTE – If the water pressure reduces please remove and clean the filter as shown below.

1. Close the shut off valve and stop the water supply.
2. Disassemble the filter – remove the filter using the 'spanner' provided.
3. Remove filter out of 'T-Piece' as shown in the illustration.
4. Clean any debris from the filter using a small brush and rinse thoroughly.
5. To reinstall please follow the reverse of the above instructions.

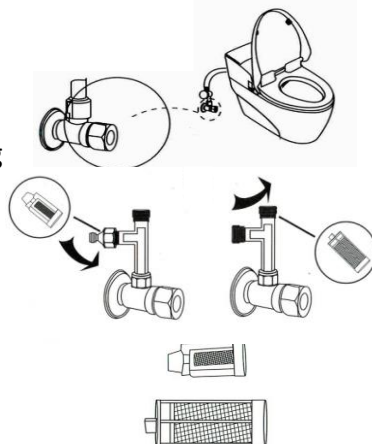

Not using the toilet for a long period

Turn off valve/T- Piece and power supply.

Trouble Shooting

<u>Problem</u>	<u>Problem Causes</u>	<u>Problem Solutions</u>
The Bidet is not working	<ol style="list-style-type: none"> 1. Bidet not plugged in. 2. No power to bidet. 3. There is power, but no functions are working when trying to use. 4. Not activated by body sensor. 	<ol style="list-style-type: none"> 1. Make sure the bidet is plugged in. 2. Check the power button on the control panel to see if it is turned 'Off.' 3. Check remote control batteries are not dead for the models with remotes.
Product shuts off during use	<ol style="list-style-type: none"> 1. Washing time exceeded (check handbook for auto timings) 2. Power failure. 	<ol style="list-style-type: none"> 1. Press the wash button to extend the time. 2. Check power to the Washloo.
Lower water flow / Spray pressure	<ol style="list-style-type: none"> 1. Clogged Mesh Filter 2. Water supply valve not opened fully. 3. Nozzle outlets are dirty/clogged. 4. Pressure settings are set too low. 	<ol style="list-style-type: none"> 1. Remove, clean and reinstall mesh filter (as per guidelines). 2. Check water supply is fully open. 3. Clean Nozzle Outlets as per guidelines. 4. Adjust water pressure settings.
Bidet wash feature does not work or fails to spray.	Body sensor does not detect that you are sat on the Washloo.	Adjust seating position to fully cover the body sensor.
Seat not heated.	Seat temperature set to off	Make sure that the seat temp setting is on Low – light 4, Med – lights 4&5 High – lights 4/5/6 and Off – No Lights.)
Water (Wash Spray) not heated.	Water temperature set to off.	Make sure that the water temp setting is on (Low – light 1, Med – light 1&2, High – 1/2/3 lights and Off – No lights)
Water flows before or after use.	Water coming from the nozzles.	<ol style="list-style-type: none"> 1. The water that comes out between the nozzles before or after use, is the 'self-cleaning' operation and is not a malfunction. 2. Residual water may drip into the bowl for several seconds after the wash or self-cleaning function has operated. This is not a malfunction.
Water leaks from areas other than the nozzles.	<ol style="list-style-type: none"> 1. Water is leaking from the T-Valve. 2. Water leaking from the Bidet hose connection. 	<ol style="list-style-type: none"> 1. Make sure that the rubber washer is inserted correctly and firmly tighten the connector. 2. Make sure the bidet hose is correctly connected and tight.

Technical Specifications

Product Specification	
Voltage	AC220-240V 50HZ
Water Supply	Direct connection to water pipe
Water Pressure	Equivalent to 0.6-7.5 BAR
Warm Washing	Water Pressure Adjustable in 4 levels
	Temperature control (4 Levels, room temperature/33°C/36°C/39°C Adjustable)
	Heater Capacity : 1520W
	Temperature Control system, , Temperature Reset Switch, Temperature fuse overheat protection with water and electricity isolation system.
Warm Air Dryer	Power : 200W
	Temperature control (4 Levels, room temperature to 52°C Adjustable)
	Temperature Control system, Temperature Reset Switch, Temperature fuse over heat protection with water and electricity isolation system.
Warm Seat	Power : 50W
	Soft Closing Lid Design
	Temperature control (4 Levels, room temperature/33°C/36°C/39°C Adjustable)
	Temperature Control system, , Temperature Reset Switch, Temperature fuse overheat protection with water and electricity isolation system.
Power Cord Length	1.5m
Safety Device	Floating Switch, temperature sensor, temperature fuse, earth leakage protection, water and electricity isolation system.
Deodorizer	Chemical absorption by deodoriser cartridge.
IP Rating	IPX4
Size	Weight 5.4kg
	510mm 380mm 150mm Remote Control 510mm 445mm 150mm Side Control
Colour	White
Certificate	CE RoHS SAA

Warranty

This electronic bidet has been designed and manufactured with great care and attention to detail. We offer a 24 month warranty.

In the following cases the warranty does not apply;

1. Damage or loss sustained in fire, earth quake, flood, thunder or other acts of providence, pollution, gas damage, salt damage and abnormal voltage.
2. Damage or loss resulting from installation methods not in the manual, any unreasonable use, abuse, negligence or improper maintenance.
3. Damage or loss resulting from modification, disassembly and destruction of the product.
4. Damage or loss resulting from hard water, water stain retention, sediments or foreign objects contained in the water system.
5. Damage or loss resulting from relocation after instalment, improper installation or in a hazardous environment.
6. Damage or loss resulting from defect caused by miss-fitting or wrongly shaped attachment.
7. Damage or loss resulting from bites by animals or insects or residual of dead animals or insects.
8. Damage or loss resulting from product freezing.
9. Damage or loss resulting from use of the product if mounted on moving vehicles such as cars, ships and caravans.
10. Damage or loss resulting from deterioration of battery etc.
11. Damage or loss resulting from lack of user's maintenance points (i.e. cleaning, filter, washer, packing etc.).
12. Damage or loss resulting from physical or accidental damage;
This includes cracks, stress marks and breakages from over extension or force of the lid cover and seat.

Important User Manual Information

If you want to dispose of this product, do not mix with general household waste. There is a separate collection system for used electronic products in accordance with legislation that requires proper treatment, recovery and recycling.

Only discard discharged batteries. They should not be disposed of in household waste, use appropriate collection sites.

Memo



Intelligently Clean, and that's the Bottom Line!

Modern Life, Smart Choice

Shades and dimensions subject to the usual tolerance.

We reserve the right to make technical modifications to the range and alter colors.