



Intelligently Clean, and that's the Bottom Line!

***Washloo Premier
All-In-One
P-Trap
Manual and Installation
Guide***

Clean Comfort Hygiene

Table of Content

Safety Precautions.....	2
Description of Parts.....	6
Operation.....	8
Other function.....	10
Accessories.....	10
Installation.....	11
Trial Operation.....	14
Maintenance.....	15
Trouble Shooting.....	16
Technical Specification.....	18
Warranty.....	19
Important User Manual Information	20

Safety Precautions

Read all instructions before use.

Save these instructions for future reference.



Warning

May result in death or injury



Caution

May result in death or injury



Warning

1. Do not use a damaged power plug or loose electrical outlet
2. Make sure to use a dedicated electrical outlet. Failing to do so may result in electric shock or fire.
3. Do not move the product by pulling the power plug.
4. Do not handle the power plug with wet hands
5. Do not forcefully bend the power cord or place heavy objects on it to prevent it from being damaged or deformed.
6. Do not connect and pull the power plug repeatedly.
7. Unplug the product before cleaning, repairing, inspecting or replacing parts.
8. Remove any dust or water from the plug.
9. Do not plug the appliance into an electrical outlet or power strip that is being used by too many appliances. Use an electrical outlet adequate for the voltage requirement of the product.
10. If the power cord is damaged, do not attempt to repair, modify or replace the cord, please contact our service centre.
11. If the product produces a strange noise, a burnt smell or emits smoke, unplug and disconnect from the electrical outlet immediately. Failing to do so may result in electric shock or fire.
12. Do not insert a wire or sharp object in any of the product gaps, or the warm air outlet. This may result in electric shock or product damage.

Safety Precautions

13. Do not place an electric heater near the product or dispose of any burning materials such as cigarettes in the toilet. This may result in fire or product deformation.
14. Do not place any containers filled with water, medicines, food, metallic objects or flammable materials on top of the product. If foreign objects enter the product, this may result in electric shock or fire.
15. Do not use the product in locations exposed to excessive moisture and do not splash water onto the product.
16. Do not use the product if it is not working correctly – Please unplug the product immediately, close off the main water supply and call our service centre. Failing to do so may result in electric shock or fire.
17. While taking a shower or cleaning the bathroom, remove the power plug from the electrical outlet and exercise caution that water or detergent does not splash onto the bidet. Failing to do so may result in electric shock or fire.
18. Do not disassemble, repair or modify the product yourself.
19. Do not use the product whilst bathing
20. Do not place or store the product where it can fall or be pulled into a bath or sink.
21. Do not place in or drop the product into water or any other liquid.
22. Do not reach for the product if it has fallen into water or liquid, disconnect from the power outlet immediately.
23. Do not operate or store the product in locations where flammable or combustible materials are used.
24. Do not use industrial water or 'grey' water for the supply as this may cause skin damage or disease.
25. Do not block the warm air outlet with your hand.
26. Turn off the water supply valve when cleaning the filter.

Safety Precautions

27. For children and seniors who have difficulties with adjusting temperature, those with sensitive skin or impaired heat sensitivity, set the temperature of the wash spray, air dryer and seat to "low" or "off" to prevent burning.

28. Close supervision is necessary when this product is used by children or persons requiring general assistance.

29. Do not press the buttons using excessive force.

30. Do not stand or place heavy objects on the seat cover.

31. Use this product for its intended purpose only. As described in this manual. Do not use any attachments that are not recommended by us.

32. Never operate this product if it has a damaged cord or plug, if it is not working properly, if it has been dropped or damaged, or dropped in water. Return the product to our service centre for examination.

33. Keep the cord away from heated surfaces.

34. Never block the air openings of the product or place it on a soft surface such as a bed or couch, where the openings may get blocked. Keep the air openings free of lint, hair etc.

35. Never use the product while sleeping or when drowsy.

36. Never drop or insert any objects into any openings or hoses.

37. Do not use the product outdoors or operate where aerosol (spray) products are being used or where it could be exposed to pure oxygen.

38. This product should be earthed in the event of an electrical short circuit earth reduces the risk of an electrical shock by providing an escape route (wire) for the electrical current. This product is equipped with a cord incorporating an earth wire and an earthed plug. The plug must be inserted into a power outlet that has been correctly installed.

39. Unplug this product before filling (fill reservoir) with water only unless otherwise specified by the manufacturer. Do not overfill.

Safety Precautions

CAUTION

1. Do not connect the mains water to the hot water pipe (only connect to cold water supply)
2. After the installation, make sure to check all water supply connections for leaks. Rubber washers should be in place for the water connection hoses and T valves.
3. Do not open/close the seat cover using excessive force.
4. Exercise caution that urine does not come into contact with the nozzles or warm air dryer outlet, failure to do so may result in bad odours or malfunction.
5. If the product will not be used for a long period of time, unplug the power cord, close the main water supply valve and drain any water in the water tank.
6. Do not pull out the bidet hose or connection hose using excessive force.
7. Do not use thinners, benzene, acidic chemicals, chloride or hydrochloric acid detergents. This may result in corrosion to the metallic components and potential discolouration or scratches to the bidet body.
8. This appliance is not intended for use by persons (including children) with reduced physical, sensory or mental capabilities, or lack of experience and knowledge unless they have been given supervision or introductions concerning the use of the appliance by a person responsible for their safety. Children should also be supervised to ensure that they do not play with the appliance.

Description of Parts

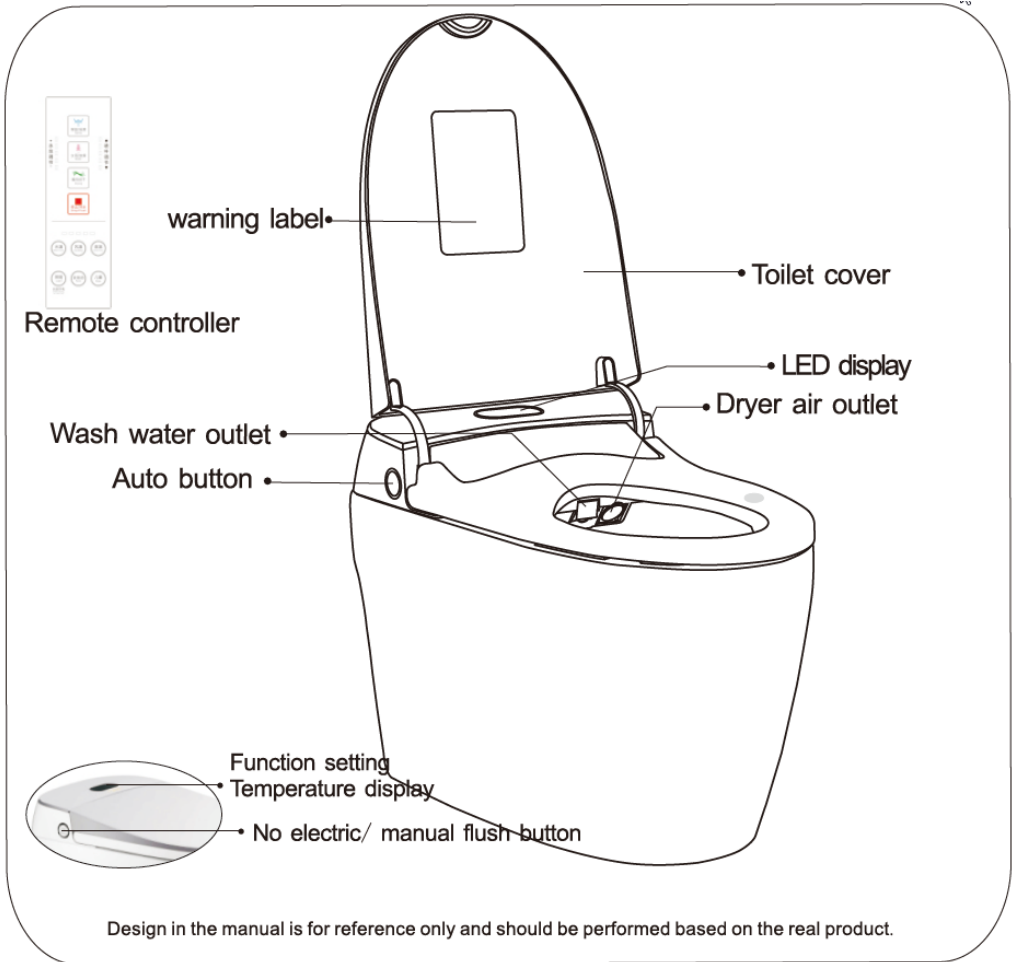

Instruction of other functions

Intelligent Toilet Flushing –
Automatic flush will operate when the user leaves the toilet.
'Stop/Flush' button will activate the flush function. If there is no electricity in the event of a power cut- use the side button to flush on the unit.



Nozzle Cleaning -
When Seated – pressing any wash function the nozzle will clean itself for 3 seconds before operation. When the user leaves the seat the nozzle will clean itself for 3 seconds again.



Automatic Deodorization-
The built in bamboo charcoal deodorant device will automatically operate when the user is seated.



Note : The above illustration is an example only, your version may vary

Description of Parts

‘Posterior Spray/Massage’

The nozzle will spray water on the user’s posterior area. Pressing the button again will move the nozzle forward and backwards.

‘Water Pressure’

This will adjust the water pressure from the nozzle – Strong , Medium and Soft.

‘Dryer Temp’

Adjusting the ‘Dryer Temperature.’

‘LOW’, MEDIUM , HIGH and off .

‘Water Temperature’

4 levels of water temperature adjustment - ‘LOW’ 33°C , MEDIUM 37°C , HIGH 40°C and Off Room Temperature.

‘Light’

Turns night light on and off

‘Save Electricity’

Intelligent Power Saving mode (lasting 8 hours).

‘Auto’

Auto Function sequence;
2 second Nozzle cleanse,
Posterior Wash(30 seconds)
Moving Spray Massage (30 seconds)

Warm Dryer (3 minutes)

By selecting the Bidet/Feminine button before the Auto button it will cycle through automatically for female occupants.

‘Stop/Flush’

Will Stop all functions when pressed.
For all-in-one units only, it will also operate the ‘Flush’ function

‘Bidet/Massage’

The nozzle will spray water on the user’s feminine area. Pressing the button again will move the nozzle forward and backwards.

‘Dryer’

3 minutes duration. Pressing again will start the moving motion drying.
Leaving the seat will automatically stop the drying action.

‘Nozzle Position Adjustment’

Adjustment to nozzle position forward and backwards (5 positions total).

‘Seat Temp’

4 temperature settings are LOW, MEDIUM, HIGH and off.

‘Kids/Child’

‘Kids/Child’ Function will operate in this sequence;
Posterior Wash (15 seconds)
Moving Massage Wash (15 seconds)
Warm Dryer (1 minutes)
Wash setting is very soft.
(Operational even without seat sensor being enabled)

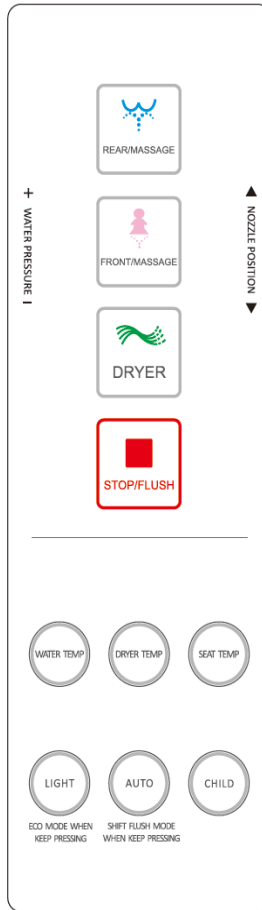

‘Power’

Power on and off

Note : The above illustration is an example only, your version may vary

Operation

`Bidet / Massage'

When you are seated and press this button, this activates the feminine wash. The nozzle comes out and sprays water on the feminine area. Press this button again and the nozzle will move forwards and backwards.

`Posterior Spray / Massage'

When you are seated and press this button, this activates the posterior wash. The nozzle comes out and sprays water on the users posterior area. Press this button again and the nozzle will move forwards and backwards.

`Water Temp'

Press `Water Temp' button to adjust the water temperature to desired level. There are 4 temperature levels;

LOW, MEDIUM, HIGH and OFF.

Please Note ; The product utilises a reservoir heating tank, temperature changes may take a few seconds to take effect.

`Water Pressure'

While cleansing function is operating, press the `water pressure' to adjust the water pressure of spray. There are three water pressure levels: LOW , MED and HIGH.

`Dryer'

Press this button to use the warm air drying function.

`Dryer Temp'

While the Dryer function is operation, press `Dryer Temp' to adjust the temperature.

There are 4 settings;

LOW, MEDIUM, HIGH and OFF.

`Light/Eco Mode'

Press this button to operate the light on and off function. Also when seated press and hold this button for 5 seconds and ECO mode will be activated. When ECO mode is enabled, and someone is seated, ECO mode will turn off and normal operation will resume. When the user leaves the seat and ECO mode is enabled, the water and seat will stop heating whilst vacant and allow the product to remain in a 'sleep mode' until reactivated.

Operation

`Seat Temp'

Use this button to control the seat temperature. Whenever the `seat temp' button is pressed. You can control the seat temperature in four levels (LOW, MEDIUM, HIGH and OFF)

`Kids'

This function is designed for children. Pressing this button activates the below process;

1. Posterior Wash (15 seconds)
2. Moving Wash (15 seconds)
3. Warm Air Dryer (1 minutes)

By pressing the `Bidet' Button before the `Kids' function, will activate the spray suitable for girls. The water spray is gentle for children. If the child's hips do not reach the sensor area, the function will still work.

`Auto'

When you are seated and press this button, this activates the below process;

1. Posterior Wash (30 seconds)
2. Moving Wash (30 seconds)
3. Warm Air Dryer(3 minutes)

Press `Bidet' button before `Auto' and the whole process will be suitable for female users.

`Nozzle position'

Adjust nozzle position using forward or backwards button according to your preference and convenience during washing.

`Stop'

All currently operating functions will stop by pressing this button

`Power'

When you press the `power' button, the product will shut itself down and all functions will become unavailable.

By re pressing this button power to the product will be restored and functions will become operational again.

Other Functions

1. Three Way Flush System

- a) Automatic flush after user has left.
- b) Press 'flush' button on remote or side panel when no one is seated.
- c) Press 'flush' button on the side of unit, can be operated without electricity.



2. The unit is fitted with a built in deodoriser which is made of bamboo charcoal.



3. Both toilet lid and seat have a damping buffer so they can close softly and silently.



4. The nozzle is self-cleansing and washes itself before and after operation has been performed.



Accessories

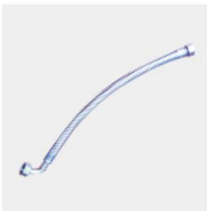

Braided Water
Hose



Water Input
Angle Valve



Remote with
batteries

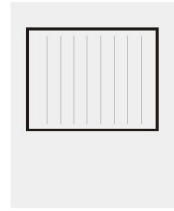

User Manual

Note : The above illustration is an example only, your version may vary

Installation

Installation

1. Measure the distance from the back of the waste outlet on the toilet to the wall hub fitting, to determine the length of the P-Trap Connector. The connector should extend approximately 2.5cm – 4cm into the hub fitting

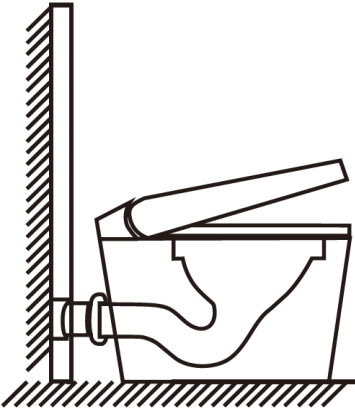

2. Trim the P-Trap adapter with a hacksaw to the appropriate length as necessary. Apply sealant around the P-Trap connector and place inside the hub fitting.

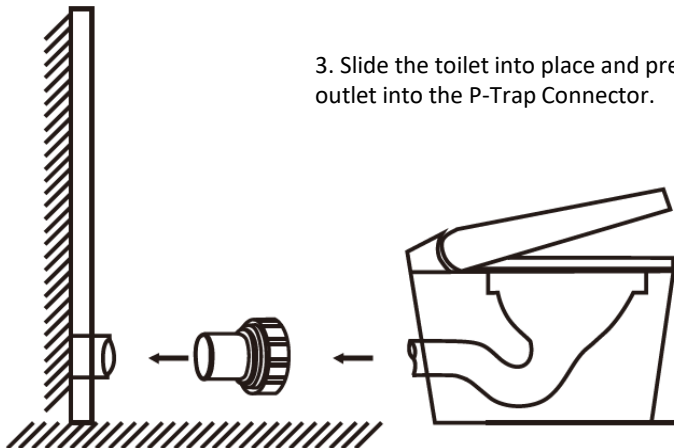

3. Slide the toilet into place and press the waste outlet into the P-Trap Connector.

Installation

Installation Continued

4. Connect the water supply pipework to the toilet. turn on the water supply and flush the toilet several times to check for any leaks around the back or base.

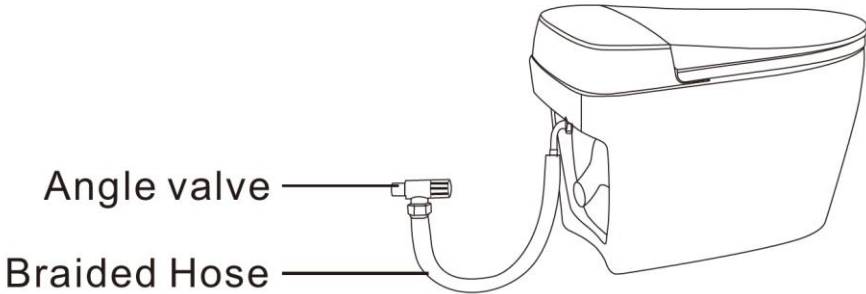

5. Finish the installation by applying sealant around the base of the toilet.

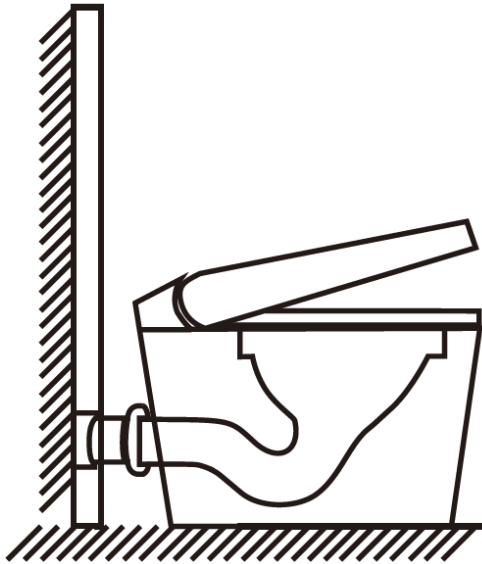

Note : The above illustration is an example only, your version may vary

Installation

Installation - Water Pipe connection and instalment.

1. Install the new water input angle valve to the end of the flexible hose
2. When the Washloo is turned on, adjust and regulate the water pressure using the water input angle valve, to achieve satisfactory water pressure.

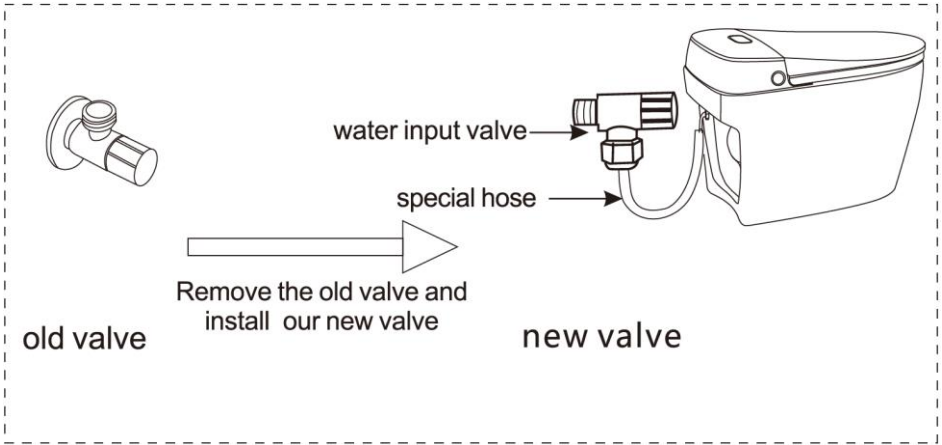

Note

This Washloo uses 'Spiral Siphon Jet Flushing Technology.' If the water pressure is set too high, it may cause additional noise when flushing through excessive water being passed through the internal Jet Flush. Use the water input angle valve to adjust the pressure to the correct level.

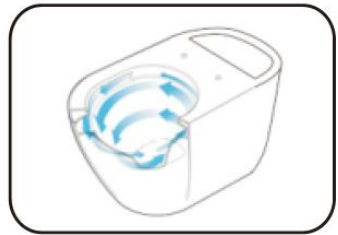

Spiral Siphon Jet Flushing

During the initial start up and operation of the Washloo, it is normal for the Nozzle to flow water when you open up the water input angle valve for the first time and also when power is connected/switched on. When removing/dismantling the Washloo, please switch of and disconnect the power and turn off the water supply via the Water input angle valve.

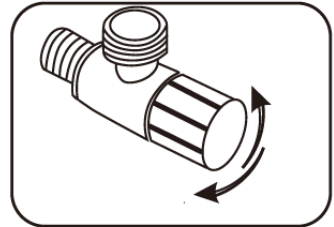

Control Valve

Trial Operation

After you have connected to the water supply, open the angle valve and switch power on. The nozzle will come out which is the self-inspection process. The water temperature indicator flashes which means the water tank is getting water and the indicator will flash when full. it is normal for the nozzle to trickle for 10-15 seconds for the first time after installation).

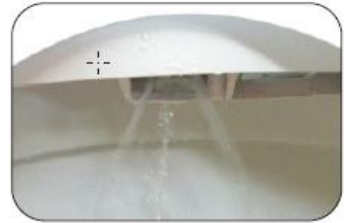

Normal Function

Note; it is normal for the nozzle to come out and trickle water when you open the angle valve. After the power is switched on, the nozzle will retract and stop flowing.

Function Confirmation

1. Please check each function according to the manual.
2. Switch on the power and put a wet towel or cloth on the sensor area. After one minute, the water will be heated to the set temperature and the warm air will work when you press the drying button.
3. When there is no power supply, no function will work.
4. To pair the remote you must be seated on the Washloo or activate the sensor using a wet towel -
Step 1 – Press and hold the side button for 5 seconds until you hear a ‘beep.’ The LED display will flash/blink at the same time, showing the Washloo is now ready to be paired.
Step 2 - Now press any key on the remote controller and the Washloo will ‘beep’ again, notifying the user that the remote and Washloo are now synced. The LED Display will stop flashing and the remote synchronisation has been complete.
Note; The Washloo and remote supplied will be paired prior to delivery. Should you require a new replacement remote, the above steps will allow the user to carry out the pairing sequence.

Example



Use wet towel to activate sensor



5. When no electric is connected to the Washloo, only the manual flush function will work located on the side of the basin.

Maintenance

Seat Cleaning

IMPORTANT; Unplug the product from the power source before cleaning or removing the seat.

Use a soft, damp cloth and a mild cleanser to wipe down the seat. **DO NOT** scrub or use abrasive products to clean the product. **DO NOT** use thinners, benzene, acidic chemicals, chloride or hydrochloric acid detergents. This may result in corrosion to the metallic components and potential discoloration or scratches to the bidet body.

Nozzle Cleaning

1. Clean the nozzle frequently. Press "Bidet Posterior Wash" button so that the nozzle comes out and clean using a soft cloth or tooth brush.
2. Do not pull hard on the nozzle. Press the 'Stop' button after finishing cleaning so that the nozzle will retract automatically.



Change Battery

Requires a 9v Battery.

1. Open Battery Case.
2. Pull out battery by the red thread.
3. Change Battery and place back in.



Maintenance

Short Term Non-Use

If the product will not be used for more than a few weeks, you can simply unplug it. You may also consider shutting down the water supply off at the wall/stop valve for extra precautions.

Long Term Non-Use

If the product will not be used for an extended period of time (i.e. few months) you should unplug the unit and shut down the water supply at the wall/stop valve. You should then drain the hot water heater system. To drain the hot water system/heater, remove the drainage screw on the back of the bidet seat. Please don't forget to replace the screw after drainage.



Trouble Shooting

If the bidet appears to be operating abnormally, please review the troubleshooting tips before contacting our service centre as most issues are easily resolved with a few simple steps. If you are unable to resolve the issue after checking the following items, please contact the service centre.

Check Before Continuing

Make sure the bidet is connected to the power supply and that the outlet is working correctly. Make sure the Remote Control has fresh batteries and they are installed correctly. (3x AAA) Make sure main water supply is connected and supply valve is open. Confirm there are no leaks from the hoses and water supply. Make sure mesh filter is clean and free from foreign objects.

After checking items above, refer to the following troubleshooting chart for additional solutions.

Trouble Shooting

<u>Problem</u>	<u>Problem Causes</u>	<u>Problem Solutions</u>
The Bidet is not working	<ol style="list-style-type: none"> 1. Bidet not plugged in. 2. No power to bidet. 3. There is power, but no operations are working when trying to use. 4. Not activated by body sensor. 	<ol style="list-style-type: none"> 1. Make sure the bidet is plugged in. 2. Check the power button on the control panel to see if it is turned 'Off.' 3. Check remote control batteries are not dead for the models with remotes.
Product shuts off during use	<ol style="list-style-type: none"> 1. Washing time exceeded (check handbook for auto timings) 2. Power failure. 	<ol style="list-style-type: none"> 1. Press the wash button to extend the time. 2. Check power to the Washloo.
Lower water flow / Spray pressure	<ol style="list-style-type: none"> 1. Clogged Mesh Filter 2. Water supply valve not opened fully. 3. Nozzle outlets are dirty/clogged. 4. Pressure settings are set to low. 	<ol style="list-style-type: none"> 1. Remove, clean and reinstall mesh filter (as per guidelines). 2. Check water supply is fully open. 3. Clean Nozzle Outlets as per guidelines. 4. Adjust water pressure settings.
Bidet wash feature does not work or fails to spray.	Body sensor does not detect that you are sat on the Washloo.	Adjust seating position to fully cover the body sensor.
Seat not heated.	Seat temperature set to off	Make sure that the seat temp setting is on (Low, Med, High and Off)
Water (Wash Spray) not heated.	Water temperature set to off.	Make sure that the water temp setting is on (Low, Med, High and Off)
Water flows before or after use.	Water coming from the nozzles.	<ol style="list-style-type: none"> 1. The water that comes out between the nozzles before or after use, is the 'self-cleaning' operation and is not a malfunction. 2. Residual water may drip into the bowl for several seconds after the wash or self-cleaning function has operated. This is not a malfunction.
Water leaks from areas other than the nozzles.	<ol style="list-style-type: none"> 1. Water is leaking from the T-Valve. 2. Water leaking from the Bidet hose connection. 	<ol style="list-style-type: none"> 1. Make sure that the rubber washer is inserted correctly and firmly tighten the connector. 2. Make sure the bidet hose is correctly connected and tight.

Technical Specifications

Product Specification	
Voltage	AC220-240V 50HZ/60HZ
Rated Power Consumption	1680W (When the inflow water temperature is 5°C, set the outflow temperature and strength/pressure to Maximum)
Power Cord Length	1.5m
Cleansing and Flushing	
Water Supply	Direct connection to water pipe
Water Pressure	Equivalent to min 2.25 BAR Static Pressure and Flow Volume is min of 20L/Min
Warm Washing	Water Pressure Adjustable in 4 levels
	Temperature control (4 Levels, room temperature/33°C/37°C/40°C Adjustable)
	Heater Capacity : 1350W
	General cleaning flow rate 0.5-0.9L/Min (Minimum required water pressure 0.15Mpa)
	Tank Capacity ; 1L
	Temperature Control system, over heat protection with water and electricity isolation system.
Warm Air Dryer	Power : 250W
	Temperature control (4 Levels, room temperature/Low/Med and High adjustable)
	Temperature Control system, over heat protection with water and electricity isolation system.
Warm Seat	Power : 50W
	Soft Closing Lid Design
	Temperature control (4 Levels, room temperature/30°C/35°C/40°C Adjustable)
	Temperature Control system, over heat protection with water and electricity isolation system.
Safety Device	Floating Switch, temperature sensor, temperature fuse, earth leakage protection, Water and electricity isolation system.
IP Rating	IPX4
Weight	45 Kgs

Warranty

This electronic bidet has been designed and manufactured with great care and attention to detail. We offer a 24 month warranty.

In the following cases the warranty does not apply;

1. Damage or loss sustained in fire, earth quake, flood, thunder or other acts of providence, pollution, gas damage, salt damage and abnormal voltage.
2. Damage or loss resulting from installation methods not in the manual, any unreasonable use, abuse, negligence or improper maintenance.
3. Damage or loss resulting from modification, disassembly and destruction of the product.
4. Damage or loss resulting from water stain retention, sediments or foreign objects contained in the water system.
5. Damage or loss resulting from relocation after instalment, improper installation or in a hazardous environment.
6. Damage or loss resulting from defect caused by miss-fitting or wrongly shaped attachment
7. Damage or loss resulting from bites by animals or insects or residual of dead animals or insects.
8. Damage or loss resulting from product freezing.
9. Damage or loss resulting from use of the product if mounted on moving vehicles such as cars, ships and caravans.
10. Damage or loss resulting from consumption of battery etc.
11. Damage or loss resulting from lack of user's maintenance points (i.e. water drain valve, filter, washer, packing etc.).
12. Damage or loss resulting from physical or accidental damage;
This includes cracks, stress marks and breakages from over extension or force of the lid cover and seat.

Important User Manual Information

If you want to dispose of this product, do not mix with general household waste. There is a separate collection system for used electronic products in accordance with legislation that requires proper treatment, recovery and recycling.

Only discard discharged batteries. They should not be disposed of household waste, use appropriate collection sites.

Memo



Intelligently Clean, and that's the Bottom Line!

Modern Life, Smart Choice

Shades and dimensions subject to the usual tolerance.

We reserve the right to make technical modifications to the range and alter colors.