



Intelligently Clean, and that's the Bottom Line!

***Washloo Supreme
All-In-One
P-Trap
Manual and Installation
Guide***

Clean Comfort Hygiene

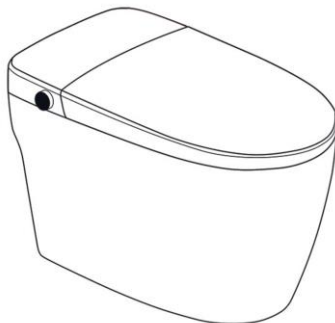

Table of Contents

Page Description	Page Number
Safety Precautions	2
Product Overview	4
Supreme – Description of Parts	6
Accessories	6
Function Operation	7
Additional Functions	10
Installation	11
Maintenance and Cleaning	15
Troubleshooting	16
Technical Specifications	17
Warranty	18
User Information	19

Safety Precautions

Read all instructions before use.

Save these instructions for future reference.



Warning

May result in death or injury



Caution

May result in death or injury



Warning

1. Do not use a damaged power plug or loose electrical outlet
2. Make sure to use a dedicated electrical outlet. Failing to do so may result in electric shock or fire.
3. Do not move the product by pulling the power plug.
4. Do not handle the power plug with wet hands
5. Do not forcefully bend the power cord or place heavy objects on it to prevent it from being damaged or deformed.
6. Do not connect and pull the power plug repeatedly.
7. Unplug the product before cleaning, repairing, inspecting or replacing parts.
8. Remove any dust or water from the plug.
9. Do not plug the appliance into an electrical outlet or power strip that is being used by too many appliances. Use an electrical outlet adequate for the voltage requirement of the product.
10. If the power cord is damaged, do not attempt to repair, modify or replace the cord, please contact our service centre.
11. If the product produces a strange noise, a burnt smell or emits smoke, unplug and disconnect from the electrical outlet immediately. Failing to do so may result in electric shock or fire.
12. Do not insert a wire or sharp object in any of the product gaps, or the warm air outlet. This may result in electric shock or product damage.

Safety Precautions

13. Do not place an electric heater near the product or dispose of any burning materials such as cigarettes in the toilet. This may result in fire or product deformation.
14. Do not place any containers filled with water, medicines, food, metallic objects or flammable materials on top of the product. If foreign objects enter the product, this may result in electric shock or fire.
15. Do not use the product in locations exposed to excessive moisture and do not splash water onto the product.
16. Do not use the product if it is not working correctly – Please unplug the product immediately, close off the main water supply and call our service centre. Failing to do so may result in electric shock or fire.
17. While taking a shower or cleaning the bathroom, remove the power plug from the electrical outlet and exercise caution that water or detergent does not splash onto the bidet. Failing to do so may result in electric shock or fire.
18. Do not disassemble, repair or modify the product yourself.
19. Do not use the product whilst bathing
20. Do not place or store the product where it can fall or be pulled into a bath or sink.
21. Do not place in or drop the product into water or any other liquid.
22. Do not reach for the product if it has fallen into water or liquid, disconnect from the power outlet immediately.
23. Do not operate or store the product in locations where flammable or combustible materials are used.
24. Do not use industrial water or 'grey' water for the supply as this may cause skin damage or disease.
25. Do not block the warm air outlet with your hand.
26. Turn off the water supply valve when cleaning the filter.

Safety Precautions

27. For children and seniors who have difficulties with adjusting temperature, those with sensitive skin or impaired heat sensitivity, set the temperature of the wash spray, air dryer and seat to "low" or "off" to prevent burning.

28. Close supervision is necessary when this product is used by children or persons requiring general assistance.

29. Do not press the buttons using excessive force.

30. Do not stand or place heavy objects on the seat cover.

31. Use this product for its intended purpose only. As described in this manual. Do not use any attachments that are not recommended by us.

32. Never operate this product if it has a damaged cord or plug, if it is not working properly, if it has been dropped or damaged, or dropped in water. Return the product to our service centre for examination.

33. Keep the cord away from heated surfaces.

34. Never block the air openings of the product or place it on a soft surface such as a bed or couch, where the openings may get blocked. Keep the air openings free of lint, hair etc.

35. Never use the product while sleeping or when drowsy.

36. Never drop or insert any objects into any openings or hoses.

37. Do not use the product outdoors or operate where aerosol (spray) products are being used or where it could be exposed to pure oxygen.

38. This product should be earthed in the event of an electrical short circuit earth reduces the risk of an electrical shock by providing an escape route (wire) for the electrical current. This product is equipped with a cord incorporating an earth wire and an earthed plug. The plug must be inserted into a power outlet that has been correctly installed.

39. Unplug this product before filling (fill reservoir) with water only unless otherwise specified by the manufacturer. Do not overfill.

Safety Precautions

CAUTION

1. Do not connect the mains water to the hot water pipe (only connect to cold water supply)
2. After the installation, make sure to check all water supply connections for leaks. Rubber washers should be in place for the water connection hoses and T valves.
3. Do not open/close the seat cover using excessive force.
4. Exercise caution that urine does not come into contact with the nozzles or warm air dryer outlet, failure to do so may result in bad odours or malfunction.
5. If the product will not be used for a long period of time, unplug the power cord, close the main water supply valve and drain any water in the water tank.
6. Do not pull out the bidet hose or connection hose using excessive force.
7. Do not use thinners, benzene, acidic chemicals, chloride or hydrochloric acid detergents. This may result in corrosion to the metallic components and potential discolouration or scratches to the bidet body.
8. This appliance is not intended for use by persons (including children) with reduced physical, sensory or mental capabilities, or lack of experience and knowledge unless they have been given supervision or introductions concerning the use of the appliance by a person responsible for their safety. Children should also be supervised to ensure that they do not play with the appliance.

Description of Parts

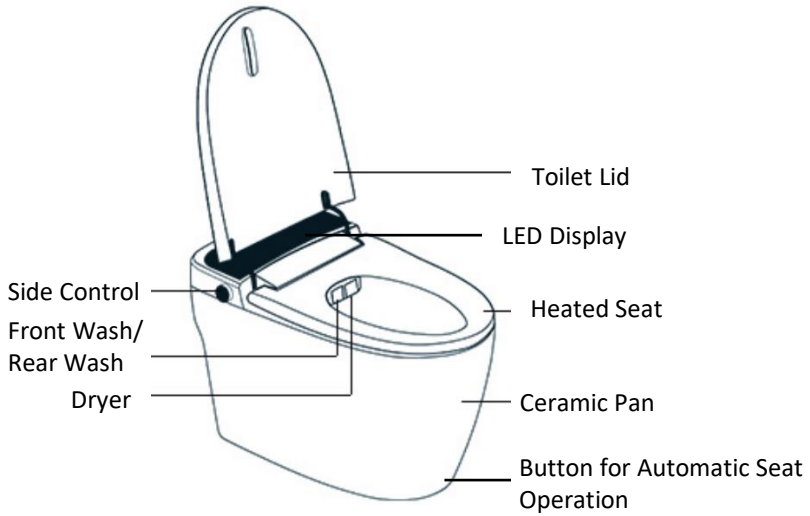

LED Display and Function Settings

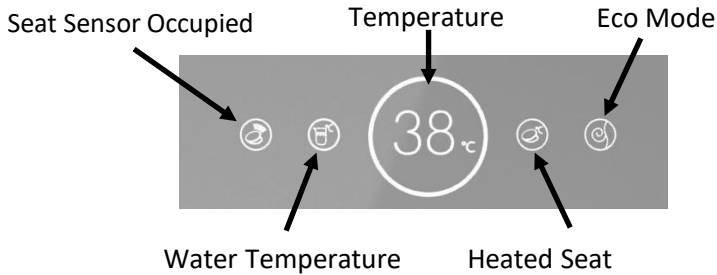

Accessories



Backup Battery for Flush



Waste Outlet Connector



Water Input Angle Valve with dual outlet



Remote with batteries

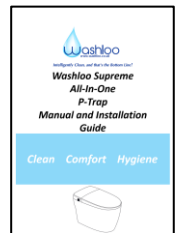

User Manual

Note : The above illustration is an example only, your version may vary

Description of Parts

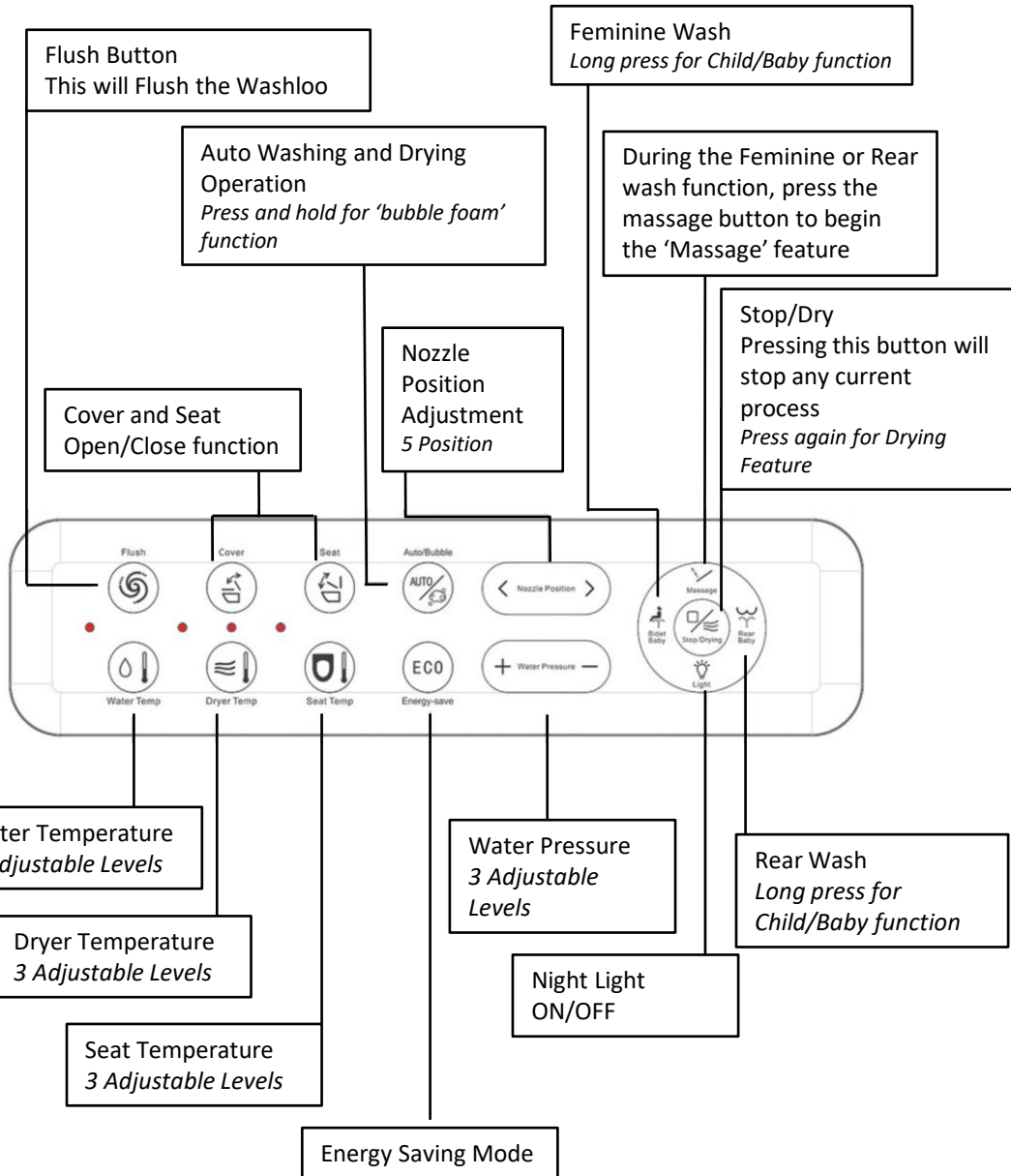

Note : The above illustration is an example only, your version may vary

Operation



`Automatic Seat and Cover Open'

Pressing this button will 'Open' the seat and cover depending on the initial position of the seat and cover. If the user leaves the seat and no 'motion' is detected, the seat and cover will automatically close after 2 minutes.



`Automatic Seat and Cover Close'

Pressing this button will 'Close' the seat and cover depending on the initial position of the seat and cover. If the user leaves the seat and no 'motion' is detected, the seat and cover will automatically close after 2 minutes.



`Posterior Spray / Massage'

When you are seated and press this button, this activates the posterior wash. The nozzle comes out and sprays water on the users posterior area. Press this button again and the nozzle will move forwards and backwards.



`Bidet / Massage'

When you are seated and press this button, this activates the feminine wash. The nozzle comes out and sprays water on the feminine area. Press this button again and the nozzle will move forwards and backwards.



`Dryer'

When seated, press and hold the 'Dryer' button to use the warm air drying function. This will activate the dryer for 3 minutes before it will automatically stop. The dryer can be stopped at anytime using the 'Stop' function.



`Stop'

All currently operating functions will stop when pressing this button.



`Nozzle position'

Adjust nozzle position using forward or backwards button according to your preference and convenience during washing. The nozzle position can be adjusted at anytime during operation. 5 positions of adjustment available.

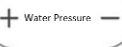

`Water Pressure'

While cleansing function is operating, press the 'water pressure' to adjust the water pressure of spray. There are three water pressure levels: LOW , MED and HIGH.



`Light'

Press this button to operate the light on and off function.



`Bubble Function'

Press and hold the 'Auto/Bubble Foam Shield' button to operate the foam shield manually. Automatic Bubble Foam, Press and hold the 'ECO' button for 5 seconds and the Auto Bubble foam function will be activated when the user sits down.

Operation

`Water Temp'



Press `Water Temp' button to adjust the water temperature to desired level. There are 3 temperature levels; LOW, MEDIUM, HIGH.

Please note; Temperature changes are controlled instantaneously, however it may take a few seconds for the temperature difference to be felt through the water flow.

`Dryer Temp'



While the Dryer function is operation, press `Dryer Temp' to adjust the temperature. There are 3 settings; LOW, MEDIUM, HIGH.

`Seat Temp'



Use this button to control the seat temperature. Whenever the `seat temp' button is pressed. You can control the seat temperature in four levels (LOW, MEDIUM, HIGH)

`ECO Mode'



Simply press the ECO mode button and the symbol will activate. When ECO mode is enabled, the heated seat will turn off until Eco mode is turned back off or someone has sat on the unit. ECO mode will turn off and normal operation will resume. When the user leaves the seat and ECO mode is enabled, the water and seat will stop heating whilst vacant and allow the product to remain in a 'sleep mode' until reactivated.

When you are seated and press this button, this activates the below process;



1. Posterior Wash (2 minutes)
2. Automatic Flush
3. Warm Air Dryer(3 minutes)

The Washloo will Automatically flush at the end of this cycle. Press `Bidet' button before `Auto' and the whole process will be suitable for female users.

Press and hold for the 'Bubble Foam' shield to be activated

'Auto Flush'



Pressing this button will operate the Flush Function. Also, when the user stands up and leaves the seat sensor, the Washloo will automatically flush. Again if the user presses the foot sensor button to close the Seat and Cover, the flush will be automatically operated

`Child/Baby Function'

This function is designed for children. Pressing and hold to activate the below process;

1. Posterior Wash (30 seconds)
2. Automatic Flush
3. Warm Air Dryer (1 minutes)

By pressing the `Bidet' Button before the `Kids' function, will activate the spray suitable for girls. The water spray is gentle for children

Other Functions

Side Control Operation

Rotate the Side Control Anti-Clockwise – to activate the Auto Bidet Wash Feature –

1. Posterior Wash (2 minutes)
 2. Automatic Flush
 3. Warm Air Dryer (3 minutes)
- The Washloo will automatically flush at the end of this cycle.

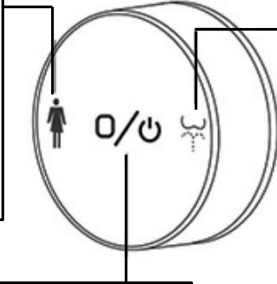

Rotate the Side Control Clockwise – to activate the Auto Rear Wash Feature –

1. Posterior Wash (2 minutes)
 2. Automatic Flush
 3. Warm Air Dryer (3 minutes)
- The Washloo will automatically flush at the end of this cycle.

When Seated – Pressing the side control in will Stop any functions that are currently in process. Pressing again will operate the drying function. When the Washloo is unoccupied, pressing the side control will operate the Flush Function

Back Lights ;

Blue - Rear Wash, Child Wash, and Automatic functions are in process.

Purple – Feminine/Bidet Wash

Red – Drying Function Active

Green – User occupying the Seat

White – No User detected

Flashing White – Flush Tank Filling

1. Four Way Flush System

- a) Automatic flush after user has left.
- b) Press 'flush' button on remote.
- c) Using the side button control – when no one is seated press the side button once for the flush to be operated
- d) Pressing the front manual Cover and Seat closing button will instruct the toilet to flush when closing.



2. Both toilet lid and seat have a automatic opening and soft close function to close silently.



3. The nozzle is self-cleansing and washes itself before and after operation has been performed.

4. UV Sterilization breaks down bacteria stopping microorganism from multiplying.

The UV Sterilization process will automatically activate when the Seat cover is closed. When the Cover is raised, the sterilization process will end and the nozzle will retract.

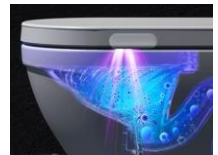

Note : The above illustration is an example only, your version may vary

Other Functions

Proximity Sensor Adjustment for Auto Open

You can adjust the sensitivity of the proximity sensor (for example if you have a smaller bathroom and the lid auto opens when you don't want it to).

Please carry out the following steps:

- 1) Hold down the "Massage" button
- 2) Select from one of the 5 levels of proximity

This may take a little trial and error to find the most suitable for your particular installation.



Installation

P-Trap Waste Configuration
Height to Centre of Waste is **17.5cms**

Please ensure the correct fall is applied to the connecting waste pipe, minimising immediate bends or turns as this may lead to poor flush performance.



Note : The above illustration is an example only, your version may vary

Installation

Installation

1. Ensure you have the correct pan connector for your installation. (Pan Connector Supplied) The Washloo Supreme has a P-Trap (Horizontal Waste). Swan neck type pan connectors can be used also.

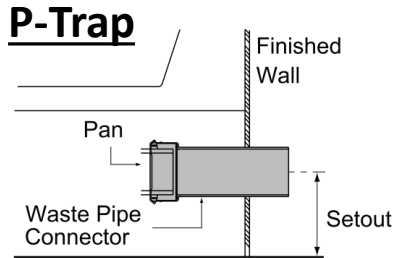

2. Mark out the final position of the Washloo in relation to the waste pipe.

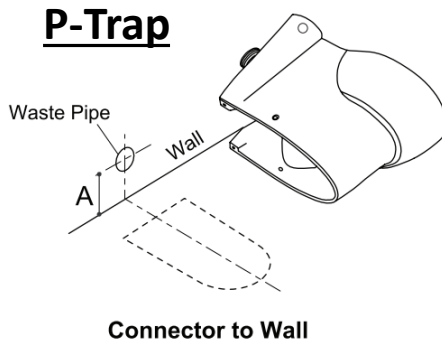

3. Position the Washloo onto the marked locations ensuring a tight seal is achieved with the Waste Outlet.

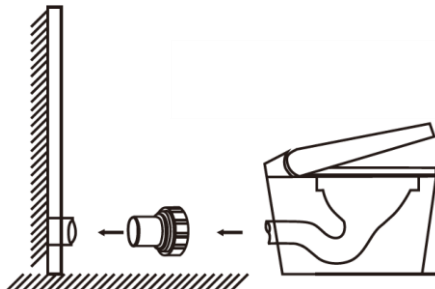

Note : The above illustration is an example only, your version may vary

Installation

Installation Continued

4. Install the supplied water angle valve and connect the braided hose that is supplied with the Washloo.

*PLEASE NOTE – Flush the braided pipe and household water pipes out first (if works are being done), to ensure no debris is passed through the braided water lines into the Washloo before the first use.

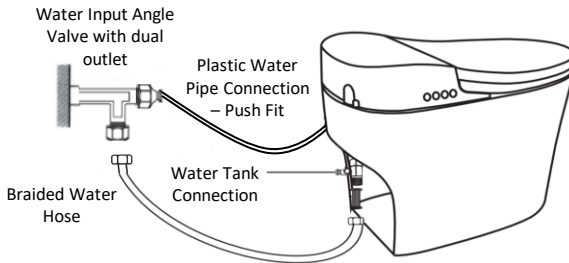

5. Finish the installation by applying sealant around the base of the Washloo.

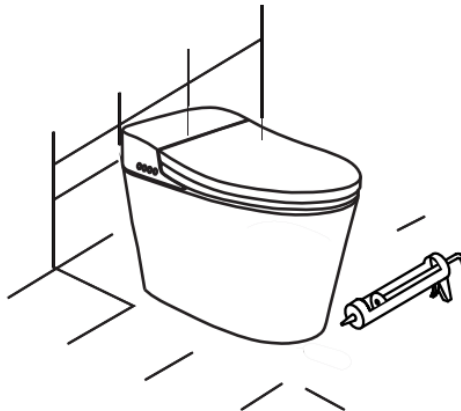

6. Once the sealant has cured, open the angle valve to allow water to reach the Washloo, then connect the power supply and turn on in preparation for First Time Use.

Note : The above illustration is an example only, your version may vary

Installation

Installation of Back-up Battery Pack

In the accessories box is the back-up battery pack which allows flushing in the event of a power outage.

Connect this to the corresponding red plug inside the back of the unit. The battery pack can sit on the base of the toilet pan, just inside the porcelain.

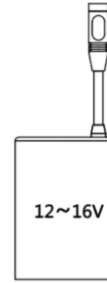

Installation of Bubble Foam Solution Bottle

Also in the accessories box is the small blue bottle of solution for the bubble foam shield. Inside the back of the unit you will find a bottle connection with 2 small grey pipes connected to it. Screw the bottle in to this cap and ensure it is secured tightly. For ease of access to refill, you may want to leave this out to the side of the toilet or alternatively, put inside the back of the toilet base.

This is also easily accessible from the top of the unit by removing the two retaining screws and carefully just lifting the top half (seat and lid) off the porcelain base to reveal inside the pan. The bottle can go in any orientation but as a safety precaution against potential leakage, it is best to keep it in an upright position.



Remote Control Pairing

To pair the remote control to the unit if it appears to be unresponsive to pressing buttons, please carry out the following steps:

- 1) Turn off electric supply to the unit/unplug
- 2) Whilst unit is off, hold down the "Dryer Temp" button for a few seconds until all lights appear on the remote
- 3) Now turn the electric supply back on or plug back in
- 4) Allow the unit to run through it's start-up procedure and then test that the remote now responds by pressing the "Flush" or "light" button on the remote



Installation

Initial Startup

After you have connected to the water supply, open the angle valve and switch power on. The nozzle will come out which is the self-inspection process. The water temperature indicator flashes which means the water tank is getting water and the indicator will flash when full. It is normal for the nozzle to trickle for 10-15 seconds for the first time after installation).

During the initial start up and operation of the Washloo, it is normal for the Nozzle to flow water when you open up the water input angle valve for the first time and also when power is connected/switched on. When removing/dismantling the Washloo, please switch off and disconnect the power and turn off the water supply via the water angle valve.

Ensure that **no more than 7.5bar** of water pressure maximum is supplied to the Washloo.

Note; it is normal for the nozzle to come out and trickle water when you open the angle valve. After the power is switched on, the nozzle will retract and stop flowing.

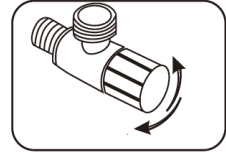
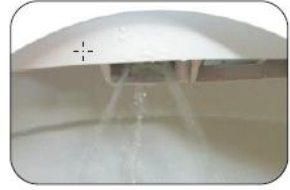

Water Input Angle Valve with dual outlet

Maintenance

Seat Cleaning

IMPORTANT; Unplug the product from the power source before cleaning or removing the seat.

Use a soft, damp cloth and a mild cleanser to wipe down the seat. **DO NOT** scrub or use abrasive products to clean the product. **DO NOT** use thinners, benzene, acidic chemicals, chloride or hydrochloric acid detergents. This may result in corrosion to the metallic components and potential discoloration or scratches to the bidet body.

Nozzle Cleaning

1. Clean the nozzle frequently. Press and hold the "Bidet" button for a few seconds so that the nozzle comes out and clean using a soft cloth or tooth brush.
2. Do not pull hard on the nozzle. Press the 'Stop' button after finishing cleaning so that the nozzle will retract automatically.



Maintenance

Short Term Non-Use

If the product will not be used for more than a few weeks, you can simply unplug it. You may also consider shutting down the water supply at the wall/stop valve for extra precautions.

Long Term Non-Use

If the product will not be used for an extended period of time (i.e. few months) you should unplug the unit and shut down the water supply at the wall/stop valve. You should then drain the flush tank system whilst the water is turned off. This will drain the Flush Tank and also stop any additional water to be supplied to the bidet features.



Pressing this button will operate the Flush Function.

Trouble Shooting

If the bidet appears to be operating abnormally, please review the troubleshooting tips before contacting our service centre as most issues are easily resolved with a few simple steps. If you are unable to resolve the issue after checking the following items, please contact the service centre.

Check Before Continuing

Make sure the bidet is connected to the power supply and that the outlet is working correctly. Make sure the Remote Control has fresh batteries and they are installed correctly. Make sure main water supply is connected and supply valve is open. Confirm there are no leaks from the hoses and water supply. Make sure mesh filter is clean and free from foreign objects.

After checking items above, refer to the following troubleshooting chart for additional solutions.

Trouble Shooting

Problem	Problem Causes	Problem Solutions
The Bidet is not working	<ol style="list-style-type: none"> 1. Bidet not plugged in. 2. No power to bidet. 3. There is power, but no operations are working when trying to use. 4. Not activated by body sensor. 	<ol style="list-style-type: none"> 1. Make sure the bidet is plugged in. 2. Check the power button on the control panel to see if it is turned 'Off.' 3. Check remote control batteries are not dead for the models with remotes.
Product shuts off during use	<ol style="list-style-type: none"> 1. Washing time exceeded (check handbook for auto timings) 2. Power failure. 	<ol style="list-style-type: none"> 1. Press the wash button to extend the time. 2. Check power to the Washloo.
Lower water flow / Spray pressure	<ol style="list-style-type: none"> 1. Clogged Mesh Filter 2. Water supply valve not opened fully. 3. Nozzle outlets are dirty/clogged. 4. Pressure settings are set to low. 	<ol style="list-style-type: none"> 1. Remove, clean and reinstall mesh filter (as per guidelines). 2. Check water supply is fully open. 3. Clean Nozzle Outlets as per guidelines. 4. Adjust water pressure settings.
Bidet wash feature does not work or fails to spray.	Body sensor does not detect that you are sat on the Washloo.	Adjust seating position to fully cover the body sensor.
Seat not heated.	Seat temperature set to off	Make sure that the seat temp setting is on (Low, Med, High and Off)
Water (Wash Spray) not heated.	Water temperature set to off.	Make sure that the water temp setting is on (Low, Med, High and Off)
Water flows before or after use.	Water coming from the nozzles.	<ol style="list-style-type: none"> 1. The water that comes out between the nozzles before or after use, is the 'self-cleaning' operation and is not a malfunction. 2. Residual water may drip into the bowl for several seconds after the wash or self-cleaning function has operated. This is not a malfunction.
Water leaks from areas other than the nozzles.	<ol style="list-style-type: none"> 1. Water is leaking from the T-Valve. 2. Water leaking from the Bidet hose connection. 	<ol style="list-style-type: none"> 1. Make sure that the rubber washer is inserted correctly and firmly tighten the connector. 2. Make sure the bidet hose is correctly connected and tight.

Technical Specifications

Product Specification	
Voltage	AC220-240V 50HZ
Rated Power Consumption	1300W (When the inflow water temperature is 5°C, set the outflow temperature and strength/pressure to Maximum)
Power Cord Length	1.5m
Cleansing and Flushing	
Water Supply	Direct connection to water pipe
Water Pressure	0.8-7.5 bar of static pressure. Not to exceed 7.5 bar of static pressure.
Warm Washing	Water Pressure Adjustable in 4 levels
	Temperature control (4 Levels, room temperature/33°C/37°C/40°C Adjustable)
	Heater Capacity :1300w
	General cleaning flow rate 0.5-0.9L/Min (Minimum required water pressure 0.8 bar)
	Temperature Control system, over heat protection with water and electricity isolation system.
Warm Air Dryer	Power : 200W
	Temperature control (4 Levels, room temperature/Low/Med and High adjustable)
	Temperature Control system, over heat protection with water and electricity isolation system.
Warm Seat	Power : 40W
	Soft Closing Lid Design and automatic open/close
	Temperature control (4 Levels, room temperature/30°C/35°C/40°C Adjustable)
	Temperature Control system, over heat protection with water and electricity isolation system.
Safety Device	Floating Switch, temperature sensor, temperature fuse, earth leakage protection, Water and electricity isolation system.
IP Rating	IPX4, KIWA/WRAS Pending
Weight	53 Kgs

Warranty

This electronic bidet has been designed and manufactured with great care and attention to detail. We offer a 24 month warranty.

In the following cases the warranty does not apply;

1. Damage or loss sustained in fire, earth quake, flood, thunder or other acts of providence, pollution, gas damage, salt damage and abnormal voltage.
2. Damage or loss resulting from installation methods not in the manual, any unreasonable use, abuse, negligence or improper maintenance.
3. Damage or loss resulting from modification, disassembly and destruction of the product.
4. Damage or loss resulting from hard water, water stain retention, sediments or foreign objects contained in the water system.
5. Damage or loss resulting from relocation after instalment, improper installation or in a hazardous environment.
6. Damage or loss resulting from defect caused by miss-fitting or wrongly shaped attachment.
7. Damage or loss resulting from bites by animals or insects or residual of dead animals or insects.
8. Damage or loss resulting from product freezing.
9. Damage or loss resulting from use of the product if mounted on moving vehicles such as cars, ships and caravans.
10. Damage or loss resulting from deterioration of battery etc.
11. Damage or loss resulting from lack of user's maintenance points (i.e. cleaning, filter, washer, packing etc.).
12. Damage or loss resulting from physical or accidental damage;
This includes cracks, stress marks and breakages from over extension or force of the lid cover and seat.

Important User Manual Information

If you want to dispose of this product, do not mix with general household waste. There is a separate collection system for used electronic products in accordance with legislation that requires proper treatment, recovery and recycling.

Only discard discharged batteries. They should not be disposed of household waste, use appropriate collection sites.

Memo



Intelligently Clean, and that's the Bottom Line!

Modern Life, Smart Choice

Shades and dimensions subject to the usual tolerance.

We reserve the right to make technical modifications to the range and alter colors.