



For FAQs and more information, please visit:

www.eufylife.com

Product Model: T2103
SM-A540-V01



Cleaning

Owner's Manual

RoboVac 11c

Table of Contents

02 Important Safety Instructions

04 About Your RoboVac

What's In the Box

RoboVac Anatomy

07 Using Your RoboVac

Important Tips Before Use

Before You Start

Install the Charging Base

Charge Your RoboVac

Start/Stop Cleaning

Select a Cleaning Mode

Schedule Cleaning

Use Your RoboVac with EufyHome App

Use Your RoboVac with Amazon Alexa (Optional)

16 Cleaning and Maintenance

Clean the Dust Collector and Filters

Clean the Rolling Brush

Clean the Sensors and Charging Pins

Clean the Side Brushes

Replace the Side Brushes

20 Troubleshooting

Error Codes

Wi-Fi Connection

23 Specifications

24 Notice

25 Customer Service

Important Safety Instructions

To reduce the risk of injury or damage, read these safety instructions carefully and keep them at hand when setting up, using and maintaining this device.



WARNING SYMBOLS USED

This is the safety alert symbol. This symbol alerts you to potential hazards that could result in property damage and/or serious bodily harm or death.

- This device is not intended for use by persons (including children) with reduced physical, sensory or mental capabilities, or lack of experience and knowledge, unless they have been given supervision or instruction concerning use of the device by a person responsible for their safety.
- Children should be supervised to ensure they do not play with the device.
- Cleaning and maintenance shall not be performed by children without adult supervision.
- This device can be used by children aged from 8 years and above and persons with reduced physical, sensory or mental capabilities or lack of experience and knowledge if they have been given supervision or instruction concerning use of the device in a safe way and understand the hazards involved.
- The device is only to be used with the power supply unit provided.
- For the purposes of recharging the battery, only use the detachable power supply unit provided with this device.
- The battery must be removed from the device before the device is disposed of. To remove the battery from the device, unscrew the battery cover using a screwdriver. Remove the battery by disconnecting the quick connector.
- The used battery should be placed in a sealed plastic bag and disposed of safely according to local environmental regulations.
- The external flexible cable or cord of the power supply unit cannot be replaced; if the cord is damaged, the power supply unit shall be disposed of.
- This device is for indoor use only.
- This device is not a toy. Do not sit or stand on this device. Small children and pets should be supervised when this device is operating.
- Store and operate this device in room temperature environments only.
- Clean with a cloth dampened with water only.
- Do not use this device to pick up anything that is burning or smoking.
- Do not use this device to pick up spills of bleach, paint, chemicals, or anything wet.
- Before using this device, pick up objects like clothing and loose paper, lift up cords for blinds or curtains, and move power cords and fragile objects out of the way. If the device passes over a power cord and drags it, an object could be pulled off a table or shelf.
- If the room to be cleaned has a balcony, a physical barrier should be used to prevent access to the balcony and to ensure safe operation.
- Do not place anything on top of this device.
- Be aware that the device moves around on its own. Take care when walking in the area where the device is operated to avoid stepping on it.
- Do not use this device on an unfinished, unsealed, waxed or rough floor. It may result in damage to the floor and the device. Use only on hard floor surfaces or low-pile carpet.
- Do not operate the device in areas with exposed electrical outlets on the floor.
- Do not expose the electronics of this device, its battery, or the integrated Charging Base. There are no user-serviceable parts inside.
- This device has been designed to be used on floors without scratching them. We still recommend that you test the device on a small area to ensure no scratches are left before cleaning the whole room.

About Your RoboVac

What's In the Box

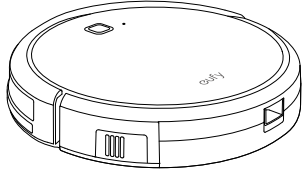

RoboVac 11c

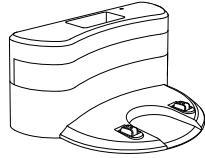

Charging Base



Remote Control

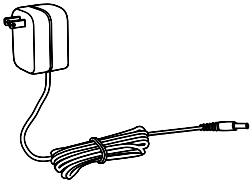

Power Adapter

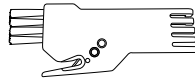

Cleaning Tool

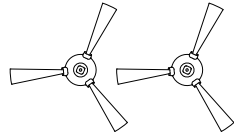

Side Brushes (×4)

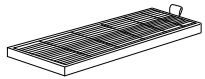

Spare HEPA-Style Filter

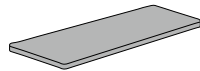

Spare Foam Filter

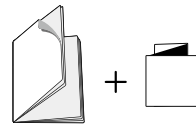

Owner's Manual & Quick Start Guide

RoboVac Anatomy

Top & Side

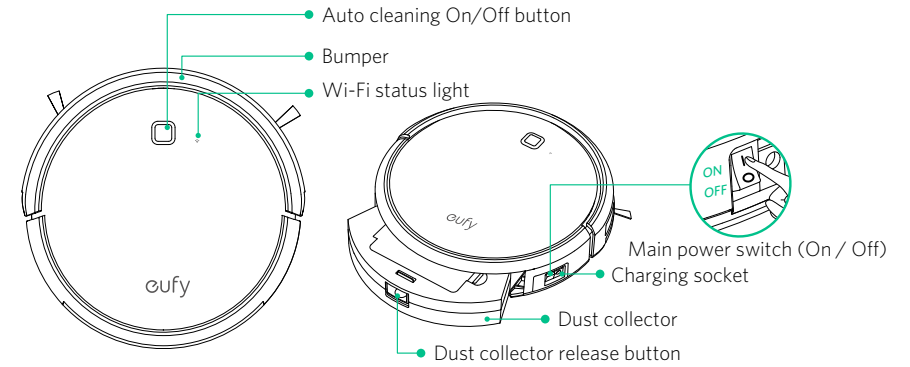

Bottom

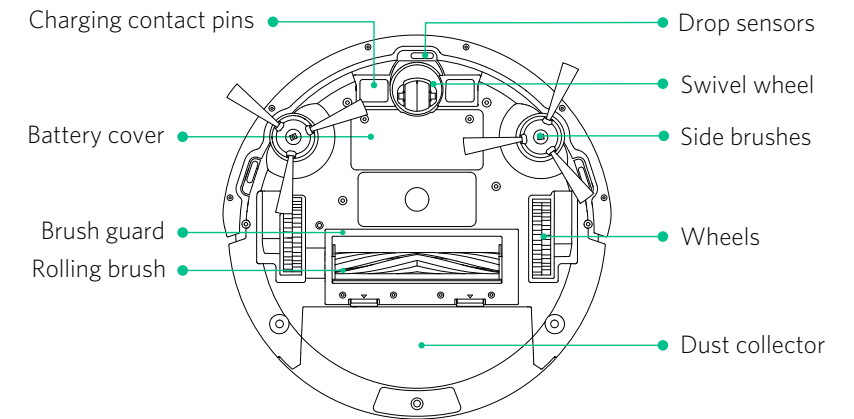

Dust Collector

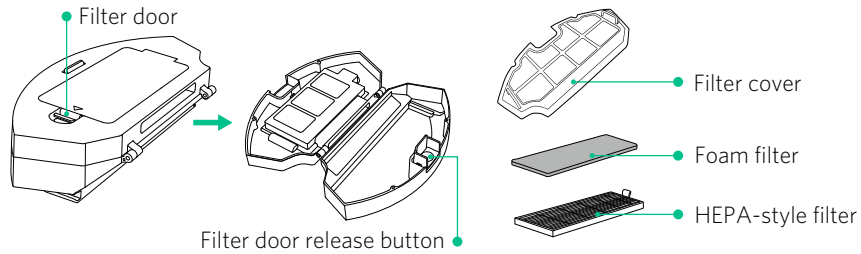

Charging Base

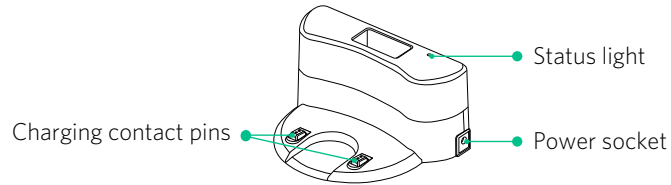

Remote Control

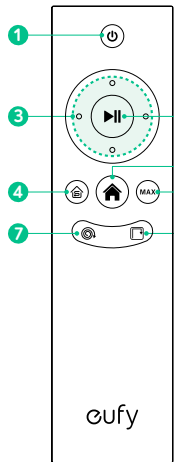

- 1 Start/Stop Auto cleaning
- 2 Start /Stop cleaning
- 3 Adjust direction manually
- 4 Start Single Room cleaning
- 5 Return RoboVac to the Charging Base
- 6 Start Max cleaning
- 7 Start Spot cleaning
- 8 Start Edge cleaning



Install 2 AAA batteries before using the remote control for the first time. Make sure the positive and negative ends are facing the correct polarity direction as marked in the battery compartment.

Using Your RoboVac

Important Tips Before Use

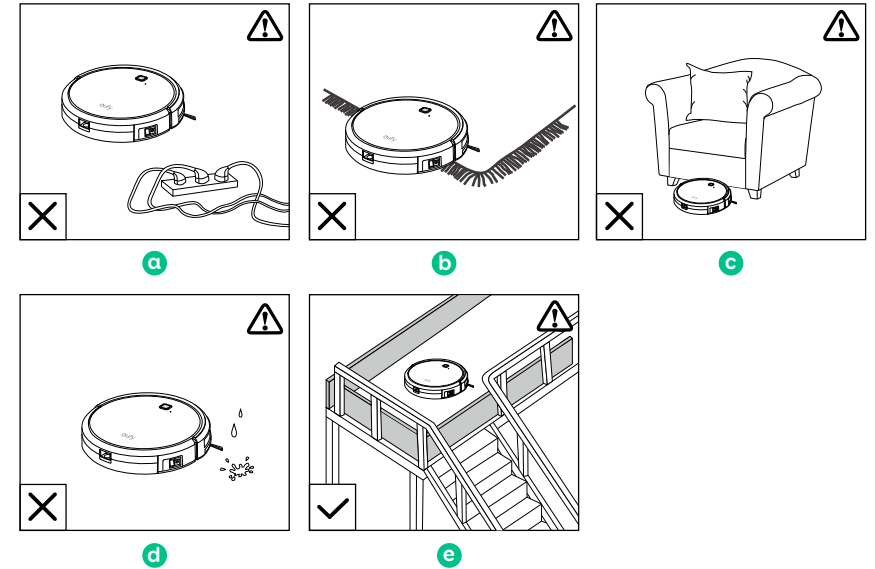

- a Remove power cords and small objects from the floor that may entangle RoboVac.
- b Remove rugs that are thicker than 0.4 in/10 mm as they may cause RoboVac to malfunction. Fold tasseled edges of area rugs underneath to prevent tangling RoboVac. Do not use RoboVac on middle or long-pile carpeting.
- c Avoid cleaning spaces lower than 3.9 in/98 mm to prevent RoboVac from getting stuck.
- d Prevent liquid from entering RoboVac as it may cause damage.
- e Anti-drop sensors prevent RoboVac from tumbling down stairs and steep drops. They may work less effectively when they are dirty, or on reflective/dark-colored floors. It is recommended to place a physical barrier to block off problem areas where the device may fall.

Before You Start

1. Remove the protective film covering RoboVac and the Charging Base.

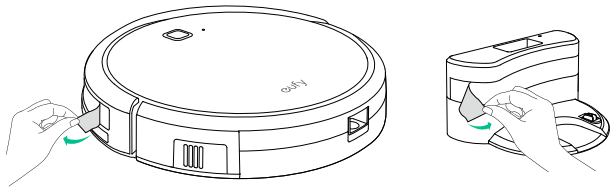

2. Flip RoboVac over and snap on the side brushes.

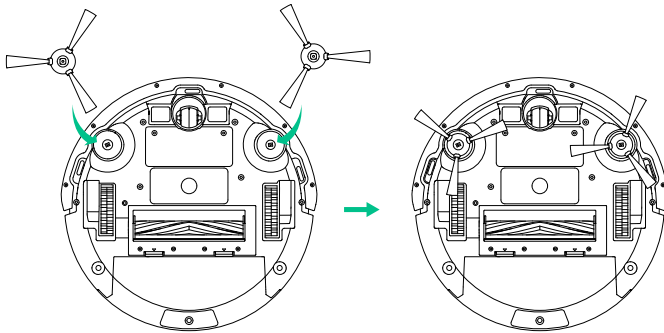

Install the Charging Base

1. Place the Charging Base on a hard, level surface and against a wall.

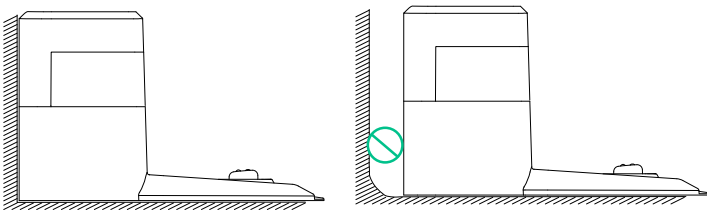

2. Remove objects within 3 ft/1 m of the left and right side and within 6 ft/2 m of the front of the charging base.

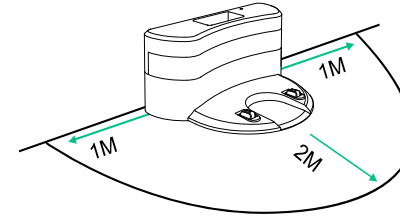

3. Connect the round connector of the adapter into the power socket on the Charging Base and the other end into a wall outlet.

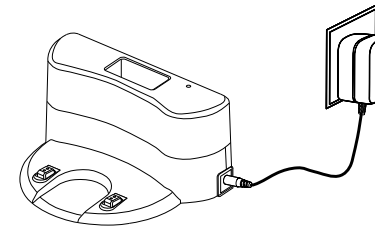

 - Install the Charging Base in a location that RoboVac can easily access.

- Always keep the Charging Base plugged in, otherwise RoboVac will not automatically return to it.

Charge Your RoboVac

- RoboVac has a pre-installed rechargeable battery that has to be fully charged before use.
- Robovac returns to the Charging Base at the end of a cleaning cycle or when its battery is running low.
- Manually charge RoboVac when its battery is fully discharged or if it fails to reach the Charging Base.

Method 1: Attach RoboVac to the Charging Base by aligning its charging pins with the charging pins on the base.

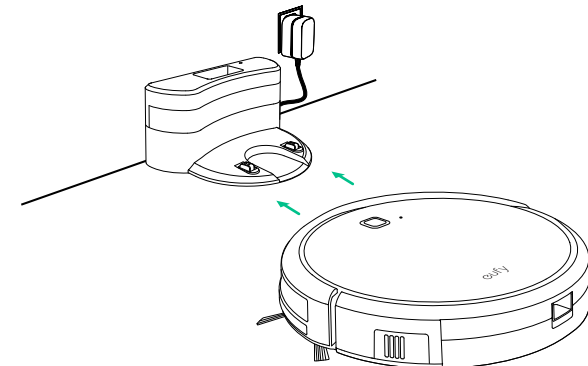

Method 2: Press  on the remote control to return RoboVac to the Charging Base.

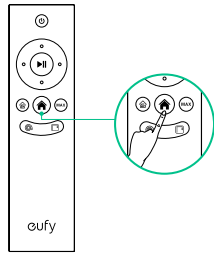

Method 3: Charge RoboVac directly with the power adaptor.

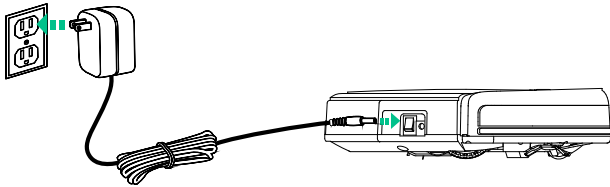

RoboVac Status Light

	Flashing red	Low power
	Flashing blue	Charging
	Solid blue	Fully charged / Cleaning / Returning to Charging Base
	Flashing / Solid red + Beeping	RoboVac has an error



- Turn off the power switch if RoboVac will not be used for a long period of time. To preserve the battery's lifespan, recharge at least once every 3 months.
- When charging RoboVac, press and hold  on RoboVac for 20 seconds to enter Reduced Power Standby Mode for power-saving. Wi-Fi is disabled in this mode. Press any key to return to Normal Mode.
- All settings will be erased when RoboVac is turned off or when the battery power is exhausted. You will need to reschedule the cleaning time on the EufyHome app.



Start/Stop Cleaning

1. Turn on the main power supply

Press the power switch on the side of RoboVac to turn on the main power supply.



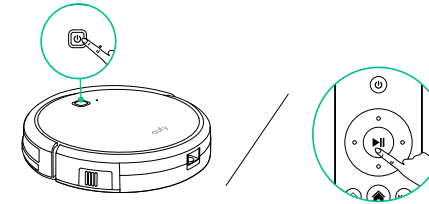

2. Start cleaning

Press  on RoboVac or  on the remote control to start cleaning in Auto mode.



When the system is idle for 10 minutes, RoboVac switches to Standby Mode automatically to save power.

3. Stop cleaning

Press  on RoboVac or  on the remote control to stop cleaning.

Select a Cleaning Mode

1. Auto cleaning

RoboVac calculates the room size and optimizes its path by selecting different cleaning modes automatically until cleaning is complete.

Press  on RoboVac or  on the remote control to start cleaning in Auto Mode.

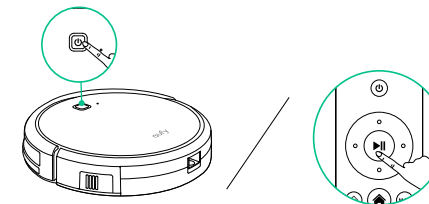



- RoboVac will return to the Charging Base automatically when the power level becomes low.
- Whenever you turn RoboVac on, it will start Auto cleaning.

2. Spot cleaning

RoboVac intensively cleans a specific area in a spiral pattern. Useful if there is a concentrated area of dust or debris.

Press  on the remote control to start cleaning in Spot Mode.

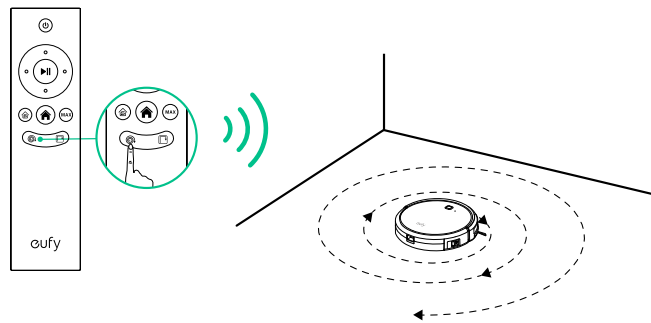

3. Edge cleaning

RoboVac reduces its speed when it detects a wall and then follows the wall to ensure the edge is cleaned thoroughly.

Press  on the remote control to start cleaning in Edge Mode.

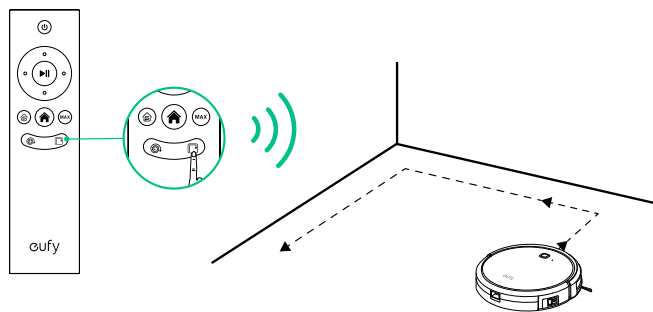

4. Single Room cleaning

RoboVac intensively cleans one single room and stops when cleaning is complete. Select this mode only when one specific room needs to be cleaned. Make sure to confine RoboVac to the room by closing the door.

Press  on the remote control to start cleaning in Single Room Mode.

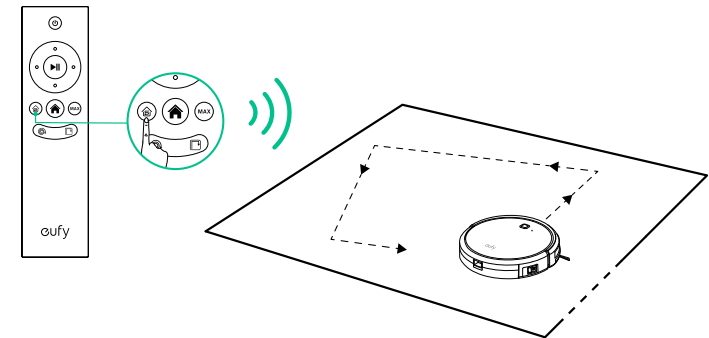

5. Max cleaning

RoboVac starts Auto cleaning with the maximum suction power. This is ideal for cleaning carpets.

Press **MAX** on the remote control to start cleaning in Max Mode.

6. Manual cleaning

You can direct RoboVac to clean a particular area by using the directional buttons on the remote control.

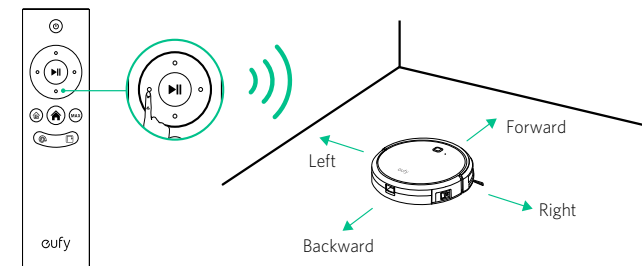

Schedule Cleaning

With the EufyHome app, you can schedule RoboVac to start cleaning at a particular time.



- You can set the time and customize the cleaning schedules from Monday to Sunday on the EufyHome app. This function is available in the app only.
- Cleaning schedules are erased when RoboVac is powered off. If RoboVac is powered on without Internet access, cleaning schedules will not synchronize and must be reset via the app.

Use Your RoboVac with EufyHome App

To enjoy full features, it is recommended to control your RoboVac via the EufyHome app.

Before you start, make sure that:

- Your smartphone has been connected to your home Wi-Fi network.
- RoboVac is attached to the charging base to ensure it has enough power during setup.
- Your smartphone is running iOS 8.0 (or above) or Android 4.3 (or above).
- The Wi-Fi status light on RoboVac is flashing blue.



- 1 Download the EufyHome app from the App Store (iOS devices) or Google Play (Android devices).
- 2 Open the app and create a user account.
- 3 Tap “+” on the top right to add RoboVac to your EufyHome account.
- 4 Follow the instructions in the app to set up Wi-Fi connection.
 - After connecting successfully, you can control RoboVac via the app.
 - With the app, you can select a cleaning mode, set the time, schedule a cleaning, learn the system status, receive notifications and access additional features.

Wi-Fi Status Light

	Flashing blue slowly	Waiting for connection
	Flashing blue quickly	Connecting with your wireless router
	Solid blue	Connected with your wireless router



- If you have any problem with Wi-Fi setup, refer to this section “**Troubleshooting > Wi-Fi Connection**”.
- If RoboVac gets stuck in any space, tap **Find My Robot** on the app to find the machine. This function is available on the app only.

Reset the Wi-Fi Connection

Press and hold on RoboVac for 10 seconds to reset the Wi-Fi connection if necessary.

- You will hear a beep when Wi-Fi has been reset.

Use Your RoboVac with Amazon Alexa (Optional)

Alexa is Amazon's smart voice control device that enables you to control RoboVac with your voice.

Before you start, make sure that:

- RoboVac is attached to the charging base to ensure there is enough power.
- RoboVac is connected with the EufyHome app.
- You have an Alexa-enabled device (sold separately) such as Amazon Echo, Echo Dot and Amazon Tap.
- The Alexa app is already installed on your smart device, and you have created an account.

- 1 Open the Alexa app and select "Skills" from the  menu.
- 2 On the **Skills** screen, search for "EufyHome - RoboVac".
- 3 Once you have found the "EufyHome - RoboVac" skill, tap **Enable**.
- 4 Login with your EufyHome account so that Alexa can control your RoboVac.
- 5 Say simple commands to Alexa:

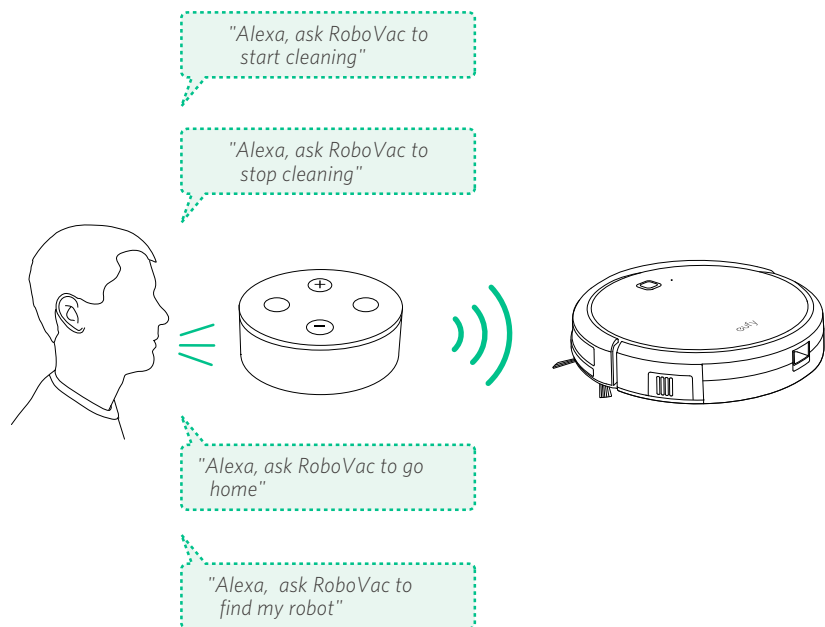

 - For more information about how RoboVac 11c works with Amazon Alexa, go to www.eufylife.com/products/robovac-11c.
 - Amazon Alexa service is available in English only now. More languages may be available later with the update of the service.

Cleaning and Maintenance

Clean the Dust Collector and Filters

- 1 Press the dust collector release button to pull the dust collector out.
- 2 Open and empty the dust collector.
- 3 Separate the filter cover by pulling the hooks as shown.

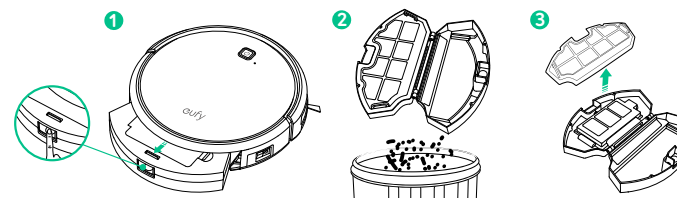

- 4 Press the filter door release button to open the filter door and take out the filters.

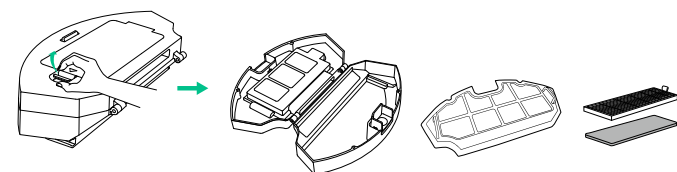

- 5 Clean the dust collector and filter with a vacuum cleaner or a cleaning brush.

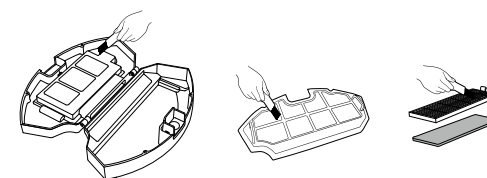

- 6 Put the filters and filter cover back together in the dust collector and close the filter door.

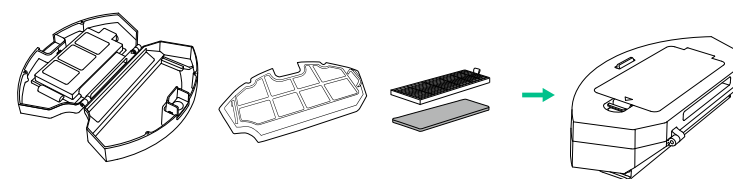

- 7 Push the dust collector back into the main unit.

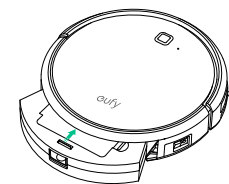

 - It is recommended to empty the dust collector and clean the filter after every use.
 - You can wash the dust collector, filter cover and foam filter with water. Be sure to air-dry them thoroughly before reassembling. Do not wash the HEPA-Style filter with water, as it may damage the filter and reduce the suction power.

Clean the Rolling Brush

- 1 Pull on release tabs to unlock brush guard as shown.
- 2 Lift the rolling brush to remove.
- 3 Clean the rolling brush with the provided cleaning tool or a vacuum cleaner.
- 4 Reinstall the rolling brush by inserting the fixed protruding end first, then clicking into place.
- 5 Press down to snap the brush guard into place.

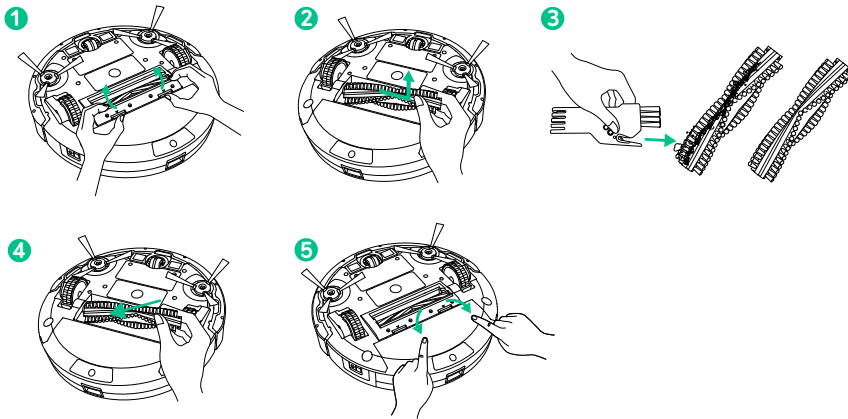

Clean the Sensors and Charging Pins

To maintain best performance, clean the drop sensors and charging pins regularly.

- Dust off the drop sensors and charging contact pins using a cloth or cleaning brush.

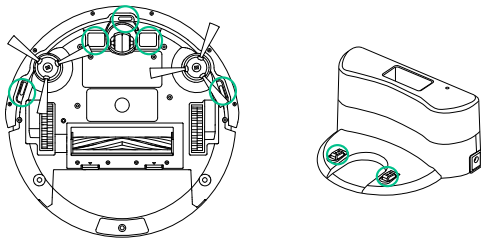

Clean the Side Brushes

Foreign substances, such as hair, can easily get tangled in the side brushes, and dirt may adhere to them. Be sure to clean them regularly.

- Carefully unwind and pull off any hair or string that is wrapped between the main unit and the side brushes.
- Use a cloth dampened with warm water to remove dust from the brushes or to gently reshape them.

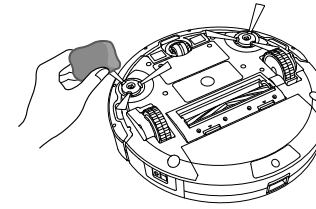

Use the side brushes only when they are completely dry.

Replace the Side Brushes

The side brushes may become bent or damaged after using for a period of time. Follow the steps below to replace them.

- Pull off the old side brushes and snap the new ones into place.

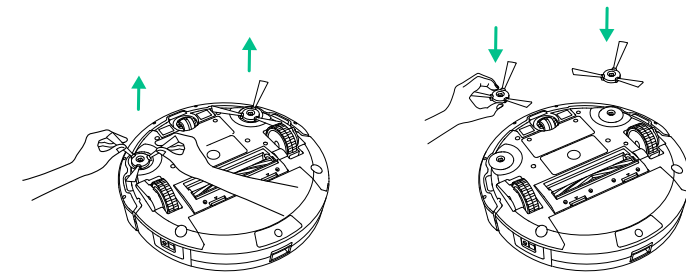

Troubleshooting

Problem	Solutions
RoboVac cannot be activated.	<ul style="list-style-type: none"> • Make sure the power switch is in the ON position. • Ensure the battery is charged. • Replace the batteries in the remote control (2 AAA batteries). • Make sure the remote control is within range (less than 3m from RoboVac).
The remote control does not work.	<ul style="list-style-type: none"> • Replace the batteries in the remote control. • Point the remote control directly at RoboVac. • Make sure RoboVac is turned on and fully charged.
RoboVac stops working suddenly.	<ul style="list-style-type: none"> • Check whether RoboVac is trapped or stuck on an obstacle. • Check whether the power level is too low.
You cannot schedule cleanings.	<ul style="list-style-type: none"> • You can set the time and scheduled cleaning time via the EufyHome app. • Make sure the scheduled time has been set correctly. • Check whether RoboVac's power is too low to start cleaning. • Cleaning schedules are erased when RoboVac is powered off. If RoboVac is powered on without Internet access, cleaning schedules will not synchronize and must be reset via the app.
Suction power is weak.	<ul style="list-style-type: none"> • Check whether any obstructions are blocking the suction inlet. • Empty the dust collector. • Clean the filter with a vacuum cleaner or a cleaning brush.
RoboVac cannot be charged.	<ul style="list-style-type: none"> • Check whether the Charging Base is plugged into the outlet. • Remove objects within 3 ft/1 m to the left and right side and within 6 ft/2 m of the front of the Charging Base. • Dust off the charging contact pins with a dry cloth.
The rolling brush does not rotate.	<ul style="list-style-type: none"> • Clean the rolling brush. • Check whether the rolling brush has been installed properly.
RoboVac's movements or travel path are abnormal.	<ul style="list-style-type: none"> • Clean the sensors carefully with a dry cloth. • Restart RoboVac by turning the power switch off and on.
You cannot control RoboVac with Alexa.	<ul style="list-style-type: none"> • Check whether you have installed the Alexa app onto your smart device and enabled "EufyHome - RoboVac" Skill in the Alexa app. For details, refer to this section "Use Your RoboVac with Amazon Alexa (Optional)". • Make sure you have an EufyHome account. • Check whether you say to Alexa with correct commands. • The "EufyHome - RoboVac" Skill for Alexa is only available in English now.

Error Codes

When RoboVac is in trouble, it will emit a series of short or long beeps and the red indicator on RoboVac will be on or flashing.

Flashing red indicator light

Error Tone	Cause	Solution
One beep	RoboVac is hanging over a ledge or is trapped.	Turn off RoboVac and restart in a new location.
Two beeps	RoboVac's bumper is stuck.	Tap RoboVac's bumper several times to dislodge any debris that may be trapped underneath.
Three beeps	RoboVac's drop sensors are dirty.	Clean the drop sensors gently with a dry cloth.
Four beeps	RoboVac's power level is too low.	Manually charge RoboVac for at least 5 hours.

Solid red indicator light

Error Tone	Cause	Solution
One beep	RoboVac's wheel is stuck.	Turn off RoboVac and remove any hair or debris from the wheel.
Two beeps	RoboVac's side brush is stuck.	Turn off RoboVac and remove any hair or debris from the side brush.
Three beeps	RoboVac's suction fan is stuck.	<ul style="list-style-type: none"> • Turn off RoboVac, then remove and empty the dust collector. • Make sure the air inlet is not blocked by any hair or debris.
Four beeps	RoboVac's rolling brush is stuck.	Turn off RoboVac and remove any hair or debris from the rolling brush.

Wi-Fi Connection

Before Wi-Fi setup, make sure RoboVac and your Wi-Fi network meet the following requirements.

Wi-Fi Setup Requirements

1 RoboVac:

- RoboVac is fully charged and the main power switch on the side of RoboVac is turned on.
- Wi-Fi status light flashes blue slowly.



2 Wi-Fi network:

- Use the correct password for your network.
- Do not use a VPN (Virtual Private Network) or Proxy Server.
- Your Wi-Fi router supports 802.11 b/g/n and IPv4 protocol.
- Your router is either 2.4GHz or a dual band router that is configured to support 2.4 GHz. RoboVac does not support 5 GHz band.
 - If RoboVac cannot connect to the Wi-Fi network and you are using a 2.4/5 GHz mixed network, switch to a 2.4 GHz network for Wi-Fi setup. You can switch back once your setup is complete.
 - When connecting to a hidden network, make sure that you have used the correct network name, SSID (case sensitive), and that the wireless frequency is 2.4GHz.
 - When using a network extender/repeater, make sure the network name (SSID) and password are the same as your primary network.
 - The firewall and port settings of your Wi-Fi router allow RoboVac to connect with the Eufy servers.
- Network Security Requirement
 - WPA and WPA2 using TKIP, PSK, AES/CCMP encryption.
 - WEP EAP (Enterprise Authentication Protocol) is not supported.
- Wi-Fi Channels
 - The FCC requires all wireless devices in the United States are operated on wireless spectrum channels 1-11.
 - Some countries outside North America can use spectrum channels above channel 11. Refer to your local regulatory agency to determine which channels are accessible.
 - A future software release will support access to channels above 11 for users outside North America. Until then, use channels 1-11.

If you cannot control RoboVac with your smartphone, find the solutions below to solve the problem. If the problem persists, contact the Eufy service center for help.

Wi-Fi Status Light 	Cause	Solution
Solid blue	RoboVac has connected to your router, but cannot access the Internet	<ul style="list-style-type: none"> • Check if your router is connected to the Internet. • Check with your Internet provider to see if there is any Internet connection problem.
Flashing blue quickly	RoboVac cannot connect to your wireless router.	<ul style="list-style-type: none"> • Check if you have modified your network name and password. • Reset the Wi-Fi connection if necessary. Refer to this section "Use Your RoboVac with EufyHome App > Reset the Wi-Fi connection"
Flashing blue slowly	Wi-Fi connection is reset or has not been set up before.	<ul style="list-style-type: none"> • Set up Wi-Fi connection with RoboVac. Refer to this section "Use Your RoboVac with EufyHome App". • Reset Wi-Fi connection if necessary. Refer to the section "Use Your RoboVac with EufyHome App > Reset the Wi-Fi connection".
Off	<ul style="list-style-type: none"> • RoboVac is turned off. • RoboVac's power level is low. • RoboVac is in Sleep Mode. 	<ul style="list-style-type: none"> • Charge RoboVac by attaching it to the charging base. Make sure the main power switch on the side of RoboVac is turned on.

Specifications

	Product Model	T2103
	Input	19 V  0.6 A
	Voltage	DC 14.8 V
	Power Consumption	27 W
	Battery Type	DC 14.8 V Li-ion 2600 mAh
	Dust collector capacity	0.6 L
	Cleaning Time	Max 100 mins
	Charging Time	300 - 360 mins
	Operating Frequency Range	2412 MHz - 2484 MHz
	Max Radio-Frequency Power	2 W

	Input	19 V  0.6 A
	Output	19 V  0.6 A

Notice



The symbol on the product or its packaging indicates:

Do not dispose of electrical appliances as unsorted municipal waste, use separate collection facilities. Contact your local authority for information regarding the collection systems available. If electrical appliances are disposed of in landfills or dumps, hazardous substances can leak into the groundwater and get into the food chain, damaging your health and well-being. When replacing old appliances with new ones, the retailer is legally obliged to take back your old appliance for disposal at least free of charge.

FCC Statement

This device complies with Part 15 of the FCC Rules. Operation is subject to the following two conditions: (1) This device may not cause harmful interference, and (2) this device must accept any interference received, including interference that may cause undesired operation.

Warning: Changes or modifications not expressly approved by the party responsible for compliance could void the user's authority to operate the equipment.

Note: This equipment has been tested and found to comply with the limits for a Class B digital device, pursuant to Part 15 of the FCC Rules. These limits are designed to provide reasonable protection against harmful interference in a residential installation.

This equipment generates uses and can radiate radio frequency energy and, if not installed and used in accordance with the instructions, may cause harmful interference to radio communications. However, there is no guarantee that interference will not occur in a particular installation. If this equipment does cause harmful interference to radio or television reception, which can be determined by turning the equipment off and on, the user is encouraged to try to correct the interference by one or more of the following measures: (1) Reorient or relocate the receiving antenna. (2) Increase the separation between the equipment and receiver. (3) Connect the equipment into an outlet on a circuit different from that to which the receiver is connected. (4) Consult the dealer or an experienced radio / TV technician for help.

Trademark Notice

Amazon, Echo, Alexa and all related logos are trademarks of Amazon.com, Inc. or its affiliates.

Apple and the Apple logo are trademarks of Apple Inc., registered in the U.S. and other countries. App Store is a service mark of Apple Inc., registered in the U.S. and other countries.

Google Play and the Google Play logo are trademarks of Google Inc.

Customer Service

-  12-Month Limited Warranty
-  Lifetime Technical Support
-  support@eufylife.com
-  1-800-988-7973(US) Mon-Fri 9am-5pm(PST)

 @EufyOfficial  @EufyOfficial  @EufyOfficial  @EufyOfficial