

INSTALLATION AND OPERATING INSTRUCTIONS

REGENERATIVE DRIVE

MODEL KBRG-212D

KB Part No. 8819

VARIABLE SPEED SCR CONTROL

DESIGNED FOR SHUNT WOUND
and PM DC MOTORS

FULL WAVE • 4 QUADRANT

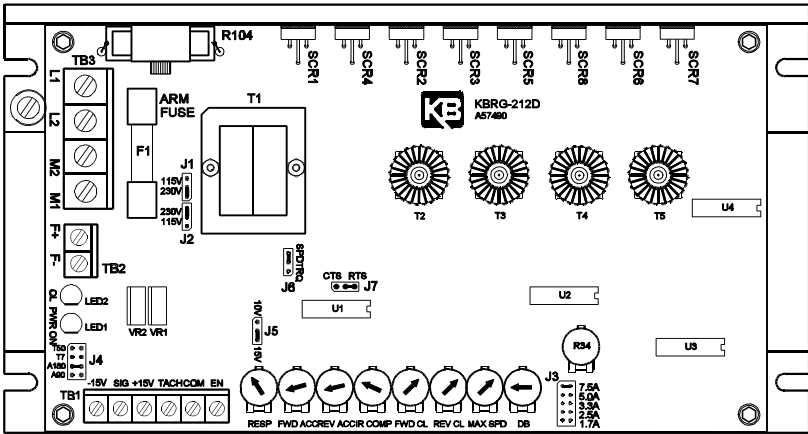

 **See Safety Warning on Page 2**

The information contained in this manual is intended to be accurate. However, the manufacturer retains the right to make changes in design which may not be included herein.



PENTA  POWER TM

A COMPLETE LINE OF MOTOR DRIVES

TABLE OF CONTENTS

<u>Section</u>	<u>Page</u>
i. KBRG-212D Simplified Operating Instructions	1
ii. Safety Warning	2
I. General Information	2
II. Operation	2
III. Setting Selectable Jumpers	3
IV. Mounting	6
V. Wiring	6
VI. Fusing	11
VII. Trimpot Adjustments	12
VIII. Function Indicator Lamps	14
IX. Limited Warranty	18

TABLES

1. Electrical Ratings	2
2. Summary of Control Operation	3
3. General Performance Specifications	3
4. Jumper J3 Position vs Motor Horsepower	4
5. Relationship of AC Line Input and Motor Voltage with J1, J2 and J4 Positions	4
6. Terminal Block Wiring Information	6
7. Field Connections (Shunt Wound Motors Only)	7
8. Armature Fuse Chart	12
9. Parts List	15, 16

FIGURES

1. AC Line Voltage Jumper Setting	4
2. Motor Armature Voltage Jumper Setting	4
3. Jumper J5 Setting	5
4. Speed Control Mode	5
5. Torque Control Mode	6
6. AC Line and Armature Connection	7
7A. Full Voltage Field	7
7B. Half Voltage Field	7
8. Control Layout	8
9. Mechanical Specifications	9
10. Main Speed Potentiometer Connections (Unidirectional)	10
11. Main Speed Potentiometer Connections (Bidirectional)	10
12. Voltage Following Connection	10
13. Regenerate to Stop	11
14. Coast to Stop	11
15. Tach-generator Feedback	11
16. Accel Trimpot Adjustment	12
17. Deadband Trimpot Adjustment	12
18. Schematic	17

i.



KBRG-212D SIMPLIFIED OPERATING INSTRUCTIONS

IMPORTANT – You must read these simplified operating instructions before you proceed. These instructions are to be used as a reference only and are not intended to replace the detailed instructions provided herein. You must read the Safety Warning on page 2 before proceeding.

1. CONNECTIONS.

A. AC Line – Wire AC line voltage to terminals L1 and L2. Be sure jumpers J1 and J2 are both set to the correct input line voltage 115 or 230 VAC. Connect ground wire (earth) to green ground screw.

B. Motor.

1. Permanent Magnet (PM Type). Connect motor armature leads to M1(+) and M2(-). Be sure jumper J4 is set to the proper position "A90" for 90 volt DC motors and "A180" for 180 volt DC motors. Note: 180 volt DC motors must be used with 230 VAC line, 90 volt motors can be used with a 230 VAC or 115 VAC line.

Note: Motor performance and efficiency, including brush life, can be adversely affected when using 90 volt motors with a 230 VAC line. (Note: Contact motor manufacturer for derating information.)

2. Shunt Wound Motors. Connect motor armature as above. Connect full voltage shunt field wires (90 volt motors with 100 volt fields and 180 volt with 200 volt fields) to F+ and F-. Connect half voltage field wires (90 volt motors with 50 volt fields and 180 volt motors with 100 volt fields) to F+ and L1.

2. SPEED OR TORQUE MODE.

Jumper J6 is factory set for speed control operation (SPD). For torque control, set J6 to TRQ position.

3. MOTOR CURRENT.

Jumper J3 is factory set for 7.5 amp motors (7.5A). For lower amperage motors, place J3 in the proper position. If motor amperage is less than 1.7 amps, use the 1.7 amp position and readjust the IR and CL trimpots according to section VII, C and D on page 13. Note: The factory setting for Current Limit is 150% of the nominal current setting (e.g., if J3 is selected for 5 amps, the actual CL setting will be 7.5 amps).

4. TRIMPOT SETTINGS.

All trimpots have been factory set in accordance with figure 8, p. 8.

5. ARMATURE FUSE.

An armature fuse (F1) rated 12A is installed, which has a rating equal to the maximum RMS rating of the control. It is recommended that the correct size armature fuse be installed depending on the rating of the motor and form factor. See table 8, page 12.

6. ENABLE.

A jumper must be connected between "EN" and "COM" terminals or control will not operate. (See sec. V, G, page 11.)



ii. SAFETY WARNING! — PLEASE READ CAREFULLY

This product should be installed and serviced by a qualified technician, electrician or electrical maintenance person familiar with its operation and the hazards involved. Proper installation, which includes wiring, mounting in proper enclosure, fusing or other overcurrent protection and grounding, can reduce the chance of electric shocks, fires or explosion in this product or products used with this product, such as electric motors, switches, coils, solenoids and/or relays. Eye protection must be worn and insulated adjustment tools must be used when working with control under power. This product is constructed of materials (plastics, metals, carbon, silicon, etc.) which may be a potential hazard. Proper shielding, grounding and filtering of this product can reduce the emission of radio frequency interference (RFI) which may adversely affect sensitive electronic equipment. If information is required on this product, contact our factory. It is the responsibility of the equipment manufacturer and individual installer to supply this safety warning to the ultimate user of this product. (SW effective 11/92)

This control contains electronic Start/Stop and enable circuits that can be used to start and stop the control. However, these circuits are never to be used as safety disconnects since they are not fail-safe. Use only the AC line for this purpose.

The input circuits of this control (potentiometer, start/stop, Inhibit) are not isolated from AC line. **Be sure to follow all instructions carefully. Fire and/or electrocution can result due to improper use of this product.**



This product complies with all CE directives pertinent at the time of manufacture. Contact factory for detailed installation instructions and Declaration of Conformity. Installation of a CE approved RFI filter (KBRF-200A, KB P/N 9945C or equivalent) is required. Additional shielded motor cable and/or AC line cables may be required along with a signal isolator (SI-4X, KB P/N 8801 or equivalent).

I. GENERAL INFORMATION.

The KBRG-212D is a full-wave regenerative control, capable of operating a DC motor (Permanent Magnet or Shunt) in a bidirectional mode. It provides 4-quadrant operation which allows forward and reverse torque in both speed directions. The drive offers excellent controllability, which closely approximates the performance of servo-type drives. Ratings and specifications are presented in tables 1 and 3. Be sure the drive is used within these ratings and specifications. **(Note: Regenerative drives normally produce more motor heating than standard unidirectional SCR speed controls, especially under low speed operation. This should be taken into consideration when specifying motor rating.)**



WARNING! Be sure to follow all instructions carefully. Fire or electrocution can result due to improper use of this product. Read Safety Warning.

TABLE 1 – ELECTRICAL RATINGS

Model	Input Voltage (VAC)	Max. AC Current (ARMS)	Output Voltage (VDC)	Max. DC Output Current (ADC)	Max. Horsepower HP, (KW)
KBRG-212D	115	12	0 – ±90	7.5	3/4, (.5)
	230	12	0 – ±180	7.5	1, (1)

II. OPERATION.

The KBRG-212D will vary motor speed or torque as a function of the signal voltage on input terminals "SIG" (signal) and "COM" (common). The input voltage can be derived from the wiper of the main speed potentiometer or from an isolated analog input (voltage following mode). Since the KBRG-212D is a 4-quadrant regenerative drive, the motor speed will follow both a positive and negative signal voltage and drive the motor in both the forward direction and reverse direction. In addition, it will apply both forward and reverse torque in order to stabilize motor speed.

To understand the concept of a regenerative drive, the operation of an elevator can be used. If one were to enter the elevator on the first floor and press 10, the motor and control would have to lift the elevator against gravity. In this mode, the drive would operate like a conventional speed control which is called “motoring” (the applied load is opposite to the direction of motor rotation). When the elevator is at floor 10 and floor 1 is pressed, gravity will try to pull the elevator car down faster than the speed for which it is set. The control will then provide reverse torque to keep the car from falling faster than the set speed. This operation is regeneration (the applied load is in the same direction as the direction of motor rotation).

The table below summarizes the different modes of regenerative operation.

TABLE 2 – SUMMARY OF CONTROL OPERATION

Quadrant	Type of Operation	Motor Rotation Direction	Motor Torque direction	Applied Load Direction
I	Motoring	CW	CW	CCW
II	Regeneration	CCW	CW	CCW
III	Motoring	CCW	CCW	CW
IV	Regeneration	CW	CCW	CW

TABLE 3 – GENERAL PERFORMANCE SPECIFICATIONS

Parameter	Specification	Factory Setting
AC Line Input Voltage (VAC $\pm 10\%$, 50/60 Hz)	115 or 230	230
AC Line Frequency (Hz), # of Phases	50/60, 1	—
Arm Voltage Range at 115VAC Line (VDC)	0 – ± 90	—
Arm Voltage Range at 230VAC Line (VDC)	0 – ± 180 , 0 – ± 90	0 – ± 180
Field Voltage at 115VAC Line (VDC)	100/50	—
Field Voltage at 230VAC Line (VDC)	200/100	—
Service Factor	1.0	—
Duty	Continuous	—
Max Load Capacity (% for 2 minutes)	150	—
Ambient Temperature Range ($^{\circ}\text{C}$)	0 – 50	—
Speed Range (Ratio)	50:1	—
Arm Feedback Load Regulation (% Base Speed)	± 1	—
Tach Feedback Load Regulation (% Base Speed)	± 1	—
Line Regulation (% Base Speed)	± 0.5	—
Current Ranges (ADC)	1.7, 2.5, 3.3 5.0, 7.5	7.5
FWD and REV Accel Range (Sec.)	0.1 – 15	1
Dead Band Range (% Base Speed)	0 – ± 3	0
Max Speed Trimpot Range (% Base Speed)	70 – 110	100
IR Comp Range at 115VAC Line (VDC)	0 – 15	5
IR Comp Range at 230VAC Line (VDC)	0 – 30	10
FWD and REV CL Range (% Range Setting)	0 – 200	150
Voltage Following Input Range (VDC)	0 – ± 10 , 0 – ± 15	0 – ± 15
Voltage Following Linearity (% Base Speed)	± 0.5	—

III. SETTING SELECTABLE JUMPERS.

The KBRG-212D has customer selectable jumpers which must be set before the control can be used (refer to fig. 1, p. 4). **Bold** indicates factory setting. See fig. 8, p. 8 for location of jumpers.

- A. **J1, J2 – Input AC Line Voltage** – Select proper input line voltage, 115VAC or 230VAC, by placing both J1 and J2 in the correct corresponding position, “115” or “**230.**” (See fig. 1.)

- B. J3 – Armature Current** – Select the J3 position (1.7, 2.5, 3.3, 5, 7.5) closest to the rated motor current. (Note the maximum output current is set to 150% of the J3 position, which may be readjusted using the FWD CL and REV CL trimpots.)

TABLE 4 – JUMPER J3 POSITION vs MOTOR HORSEPOWER

	Jumper J3 Position Motor Current (DC Amps)	Motor Horsepower	
		90VDC	180VDC
7.5A	7.5A	3/4	1
5.0A	5.0A	1/2	1
3.3A	3.3A	1/3	3/4
2.5A	2.5A	1/4	1/2
1.7A	1.7A	1/6	1/3

- C. J4 – Motor Armature Voltage** – Select the desired armature voltage by placing J4 in the proper position, “A90” or “A180.” **Note: For 115 volt AC Line input, the armature voltage must be set to “90.”** For 230 input, the armature voltage is normally set for “180.” However, it is also possible to set the armature voltage to “90” for step-down operation. (See fig. 2 and table 5.) **Note: Jumper J4 is also used if tach-generator feedback is to be used. (See fig. 2)**

If a 7 volt per 1000 RPM tach-generator is used, place jumper J4 into the “T7” position. For a 50 volt per 1000 RPM tach-generator, place the jumper into the “T50” position.

Note: When using tach-generator feedback, the IR Comp trimpot should be turned to a minimum setting (full CCW).

FIG. 1 – AC LINE VOLTAGE JUMPER SETTING

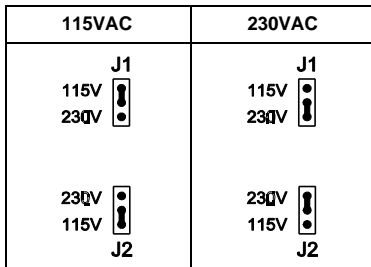

FIG. 2 – MOTOR ARMATURE VOLTAGE JUMPER SETTING

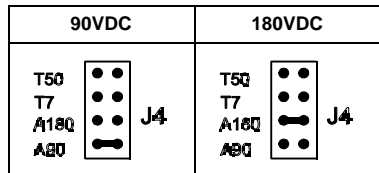



TABLE 5 – RELATIONSHIP of AC LINE INPUT AND MOTOR VOLTAGE with J1, J2 and J4 JUMPER POSITION

AC INPUT VOLTAGE	J1, J2 POSITION	J4 POSITION	MOTOR VOLTAGE
115	115	90	90
230	230	180	180
230	230	90*	90*

*A 90VDC motor can be used with a 230VAC line. However, speed range may be reduced and motor derating may be required.

- D. **J5 – Analog Input Voltage** – Jumper J5 is set to the “15V” position for potentiometer operation. If the control is to be operated from an *isolated* 0 – ±10VDC signal, set J5 to the “10V” position. (See sec. V, F, p. 10.) (See fig. 3.)

FIG. 3 – JUMPER J5 SETTING

Potentiometer Operation	Signal Following
J5 SET FOR 15V POSITION  15V	J5 SET FOR 10V POSITION  10V 15V

- E. **J6 – Control Mode** – Speed (SPD) or Torque (TRQ). (Note: Factory setting of J6 is Speed mode.) In the speed control mode (J6 set to SPD), the KBRG-212D will provide variable speed control. The motor speed will be in direct proportion to the input signal. Both forward and reverse torque are used to stabilize motor speed. (See fig. 4.)

FIG. 4 – SPEED CONTROL MODE

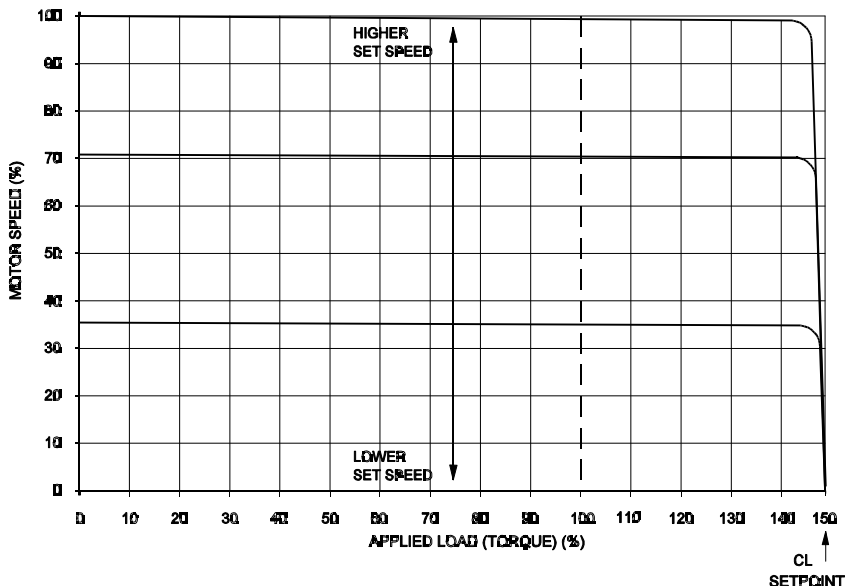

In the torque control mode (J6 set to TRQ), the KBRG-212D will vary the maximum motor torque as a function of the voltage input to terminals “SIG” (signal) and “COM” (common). This voltage can be derived from the wiper of the main potentiometer or from an isolated analog input (voltage following). If the motor torque is greater than the load torque, the motor will rotate. If no load is applied to the motor, the motor will rotate at a speed proportional to the torque setting as set by the main potentiometer (see fig. 5, p. 6). By using the ACCEL and DECEL trimpots, the application of torque can be made more gradual or less gradual as required by the application. A maximum torque can be established using the current selector jumper, J3, which can be further modified by using the FWD and REV CL trimpots.

- F. **J7 – Coast to Stop (CTS), Regenerate to Stop (RTS)** – This function operates in conjunction with the Enable circuit, which is used to start and stop the control electronically. If the circuit connecting terminals “EN” and “COM” on terminal block TB1 is opened, the control will cause the motor to stop. When jumper J7 is in the factory position (RTS), the motor will regenerate to a stop. The stop time is controlled by the Forward Acceleration (FWD ACC) and Reverse Acceleration (REV ACC) trimpots.

If J7 is changed to the coast to stop (CTS) position, the motor will coast to a stop when the “EN” - “COM” circuit is opened. **Note: Control will not run unless a jumper or closed contact is connected between the “EN” and “COM” terminals.**

FIG. 5 – TORQUE CONTROL MODE

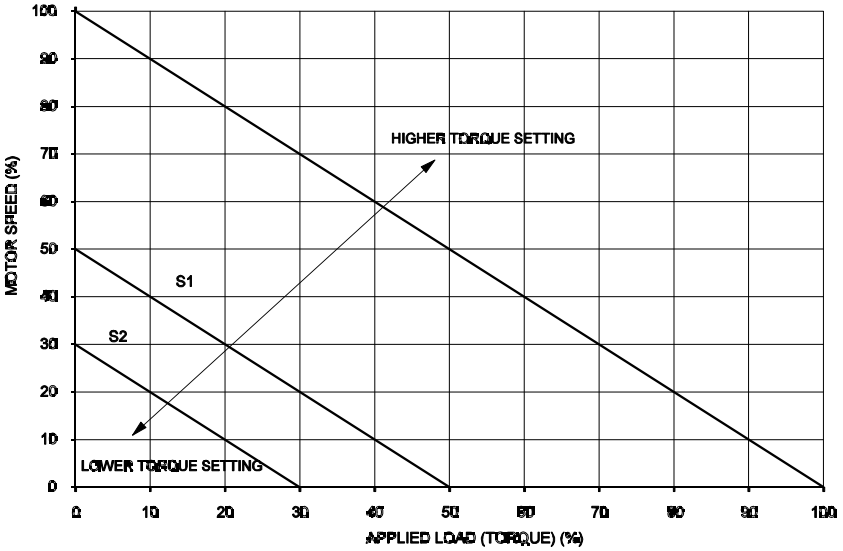

IV. MOUNTING.

Mount the KBRG-212D on a flat surface free of moisture, metal chips, or corrosive atmosphere. See Mechanical Specifications fig. 9, p. 9. A 5K ohm remote speed potentiometer is provided with each control. Install potentiometer using hardware provided. Be sure to install insulating disk between potentiometer and inside of front panel.

Enclosure – When mounting the KBRG-212D in an enclosure, it must be large enough to allow the proper heat dissipation. A 12"12"24" enclosure is suitable at full rating (7.5 Amps). Smaller enclosures may be used if full rating is not required.

V. WIRING.  **Warning! Read Safety Warning before attempting to use this control.**

Warning! To avoid erratic operation do not bundle AC Line and motor wires with potentiometer, voltage following, enable, inhibit or other signal wiring. Use shielded cables on all signal wiring over 12" (30 cm) – Do not ground shield.

Wire control in accordance with National Electrical Code requirements and other local codes that apply. A "normal blo" 15 amp fuse or circuit breaker should be used on each AC line conductor which is not at ground potential (do not fuse neutral or grounded conductors). (See section VI, p. 11 for fuse information.) Wire control in accordance with connection diagrams (see figures 6, 7A, 7B on page 7 and figures 10 - 12 on page 10). A separate AC Line switch or contactor must be wired as a disconnect switch so that contacts open each ungrounded conductor of the control. See table 6 for terminal block wiring information.

TABLE 6 – TERMINAL BLOCK WIRING INFORMATION

Terminal Block Designation	Connection Designation	Supply Wire Gauge*		Maximum Tightening Torque (lbs inch)
		Minimum	Maximum	
TB1	Logic Connections	22	14	3.5
TB2	F+, F-	22	14	3.5
TB3	L1, L2, M2, M1	22	12	12

- A. **AC Line** – Connect AC Line to terminals L1 and L2. (Be sure jumpers J1 and J2 are set to match the AC Line voltage used.) (See table 5, p. 4.)
- B. **Motor Armature** – Connect motor armature to terminal M1 and M2. (Be sure jumper J4 is set to match motor voltage.) (See table 5, p. 4.)
- C. **Ground** – Be sure to ground (earth) control via green screw located on chassis. **Do not ground any other terminals.**
- D. **Field** – For Shunt Wound motors **only**. Do not use F+ and F- terminals for any other motor type. Connect motor shunt field to terminals F+ and F- for 90VDC motors with 100VDC fields and 180VDC motors with 200VDC fields. For motors with half voltage fields, 90VDC motors with 50VDC fields and 180VDC motors with 100VDC fields, connect field to terminals F+ and L1. See table 7 for summary of field connections.

CAUTION – Shunt-Wound motors may be damaged if field remains powered without motor rotating for an extended period of time.

FIG. 6 – AC LINE AND ARMATURE CONNECTION

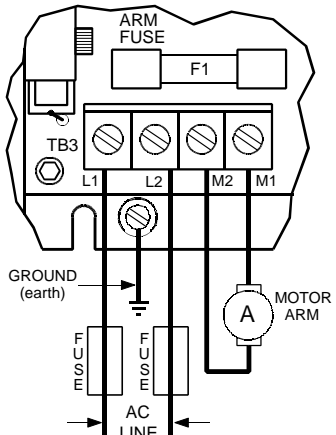

FIG. 7A – FULL VOLTAGE FIELD

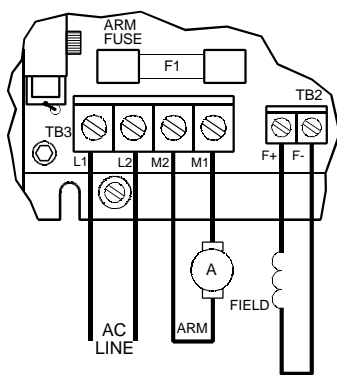

FIG. 7B – HALF VOLTAGE FIELD

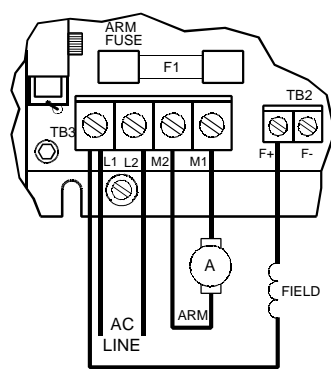
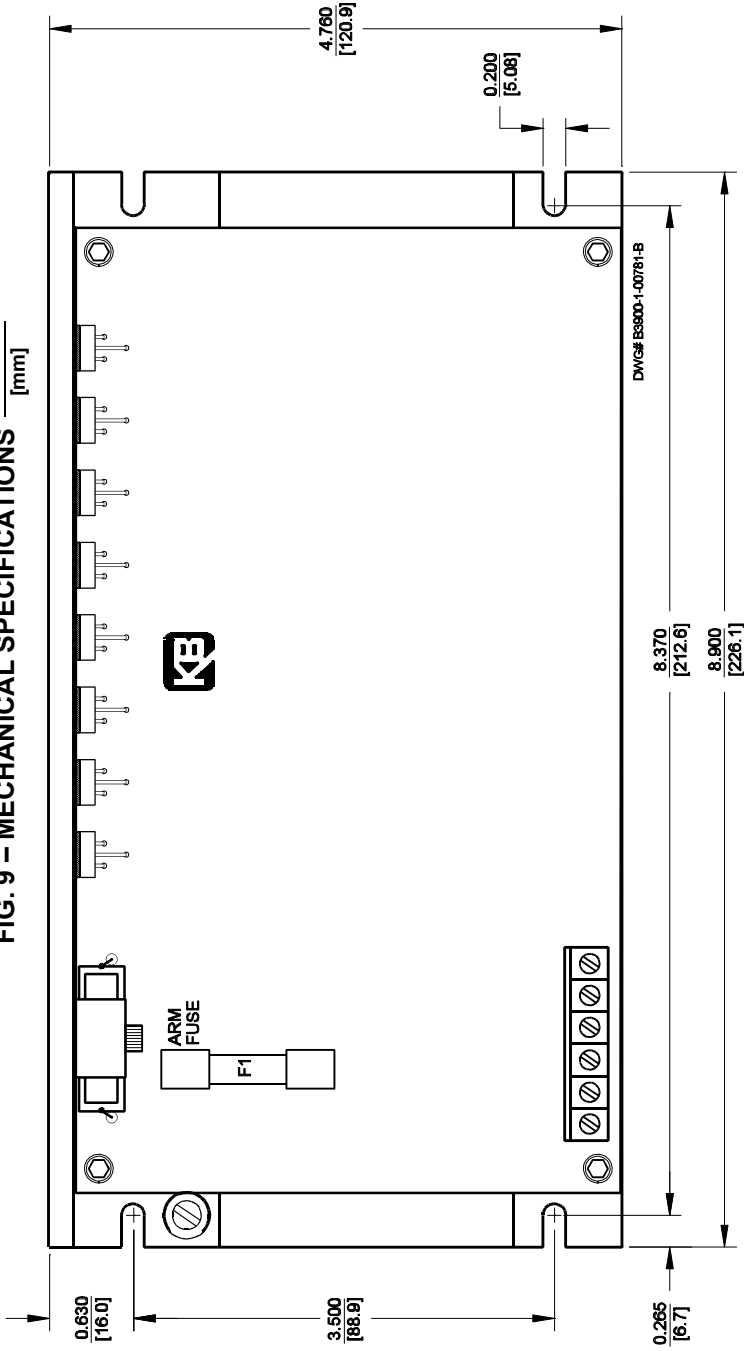

TABLE 7 – FIELD CONNECTIONS (Shunt Wound Motors Only)

AC Line Voltage (VAC)	Motor Voltage	Field Voltage (VDC)	Field Connection
115	90	100	F+, F-
115	90	50	F+, L1
230	180	200	F+, F-
230	180	100	F+, L1
230	90*	100	F+, L1

*Step Down operation (see sec. III C, p. 4).

FIG. 9 – MECHANICAL SPECIFICATIONS INCHES
[mm]



NOTES: MAXIMUM HEIGHT WITHOUT ACCESSORY BOARD IS 1.700 [43.2]

MAXIMUM HEIGHT WITH ACCESSORY BOARD IS 3.100 [78.7]

E. Main Speed Potentiometer – The main speed potentiometer can be connected in several ways using terminals “COM,” “+15,” “SIG” and “-15.” A 5K ohm potentiometer is supplied with control. (A 10K potentiometer can also be used.) (**Warning! Terminals “COM,” “+15,” “SIG” and “-15” are not isolated from AC line.**) Note: Jumper J5 must be in the “15V” position.

- i. **Unidirectional operation only** – Connect potentiometer to terminals “COM,” “+15,” “SIG” for forward direction. To operate in reverse direction, connect to “COM,” “SIG,” and “-15.” See fig. 10.
- ii. **Bidirectional operation only** – Connect to terminals “COM,” “+15,” “SIG,” and “-15” when using reversing contacts. To operate with a potentiometer, connect to “+15,” “SIG,” and “-15.” See fig. 11.

FIG. 10 – MAIN SPEED POTENTIOMETER CONNECTIONS (Unidirectional)

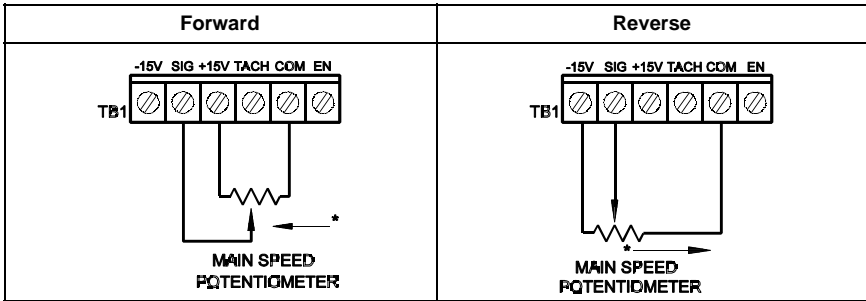
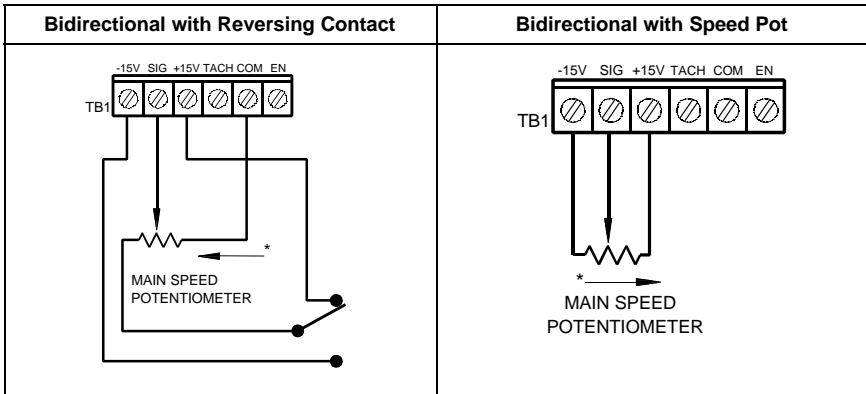

FIG. 11 – MAIN SPEED POTENTIOMETER CONNECTIONS (Bidirectional)



*Note: Arrow indicates increase in motor forward speed.

F. Voltage Following – An *isolated* analog voltage can be used in lieu of main speed potentiometer. Connect signal to terminals “SIG” and “COM.” Note: Terminal “COM” is common. A positive signal with respect to terminal “RB1” will produce a positive output to motor. A negative signal with respect to terminal “COM” will produce a negative output. A 0 to ± 10 VDC is required to operate control from 0 \pm full output. (A bipolar signal isolator, SI-4X [KB P/N 8801], is available as an option from your distributor.) Note: Jumper J5 must be in the “10V” position. **Note: An isolated signal voltage must be used or catastrophic failure can result.**

FIG. 12 – VOLTAGE FOLLOWING CONNECTION

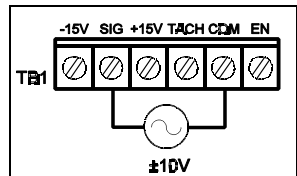

- G. Enable Start/Stop Circuits** – The KBRG-212D contains a 2-wire stop circuit (Enable) which is used to electronically bring the motor to a “stop.” An *isolated* single contact closure is required. If an isolated contact is not available, it may be necessary to use an isolation relay.



WARNING! Do not use Start/Stop or Enable functions as a safety disconnect. Use only an AC line disconnect for that purpose.

- i. **Regen to a stop using terminals EN and COM on terminal block TB1** – When a contact is opened between terminals “EN” and “COM”, with jumper J7 in the “RTS” position, the motor will regeneratively brake to a stop. The braking time can be controlled by adjusting the REV ACC trimpot when the motor is in the forward direction and the FWD ACC trimpot when the motor is in the reverse direction. See fig. 13.

FIG. 13 – REGENERATE TO STOP

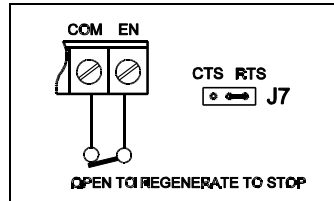

- ii. **Coast to a stop using terminals “EN” and “COM” on terminal block TB1** – If coast to stop operation is required, move jumper J7 to the coast to stop (CTS) position. When the contact is opened between “EN” and “COM,” the motor will coast to a stop. See fig. 14.

FIG. 14 – COAST TO STOP

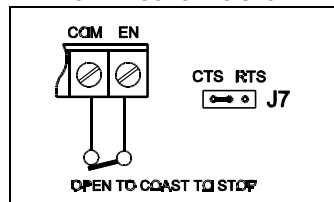

- H. Tach-generator Feedback** – The KBRG-212D is factory set for armature feedback which provides good load regulation for most applications. For superior load regulation analog tach-generator feedback can be used.

Wire the tach-generator so that the polarity of the tach-generator is the same with respect to the input signal polarity (see fig. 15). Note: If tach-generator is wired with reverse polarity, the motor will run at full speed.

FIG. 15 – TACH-GENERATOR FEEDBACK

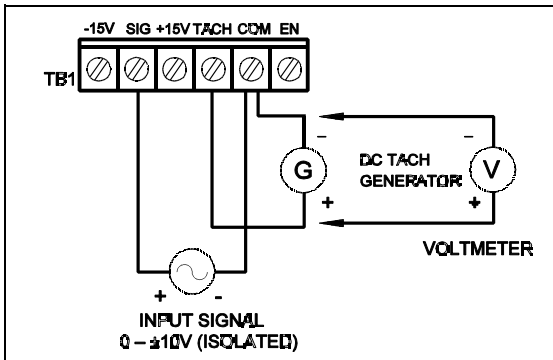

NOTE: Check tach voltage polarity with respect to input signal if polarity does not match reverse tach leads.

Be sure AC line is disconnected when rewiring tach-generator.

VI. FUSING.

Armature Fuse – An armature fuse (F1) rated 12A is provided with a rating equal to the maximum RMS rating of the control. It is recommended that the correct size armature fuse be installed, depending on the rating of the motor and form factor (RMS/AVG current). Fuse type should be Littlefuse 326 ceramic or Buss ABC, or equivalent. A fuse chart is presented below which suggests appropriate armature fuse ratings. However, the specific application may require larger fuse ratings based on ambient temperature, CL set point and duty cycle of operation (see table 8, p. 12). Fuses may be purchased from your distributor.

TABLE 8 – ARMATURE FUSE CHART

Motor Horsepower		Approx. DC Motor Current Amps	Fuse Rating (AC Amps)
90VDC	180VDC		
1/8	1/4	1.3	2
1/6	1/3	1.7	2
1/4	1/2	2.5	4
1/3	3/4	3.3	5
1/2	1	5.0	8
3/4	1	7.5	12

VII. TRIMPOT ADJUSTMENTS.

The KBRG-212D contains trimpots which have been factory adjusted for most applications. See specifications for factory settings. (Note: Fig. 8 p. 8 presents the various trimpots with their location. They are shown in the approximate adjustment position.) Some applications may require readjustment of trimpots in order to tailor control to exact requirements. Readjust trimpots as follows:

A. Forward Acceleration (FWD ACCEL) and Reverse Acceleration (REV ACCEL) – The FWD ACCEL trimpot determines the amount of time it takes the control voltage to reach full output in the forward direction. It also determines the amount of time it takes for the control voltage, in the reverse direction, to reach zero output. (FWD ACCEL is the Reverse Decel.)

The REV ACCEL trimpot determines the amount of time it takes the control voltage to reach full output in the reverse direction and the time it takes for the control voltage, in the forward direction, to reach zero output. (REV ACCEL is the Forward Decel.)

The FWD and REV ACCEL trimpots are factory adjusted to approximately 1 second. The acceleration times are adjustable over a range of 0.1 to 15 seconds. See fig. 16 for graphical representation of ACCEL.

Note: The FWD and REV CL trimpots may override the rapid accel and decel settings.

Note: A 4-quadrant ACCEL/DECEL accessory module (KB P/N 8803) is available as an option. It provides separate control of FORWARD acceleration and deceleration and REVERSE acceleration and deceleration.

FIG. 16 – ACCEL TRIMPOT ADJUSTMENT

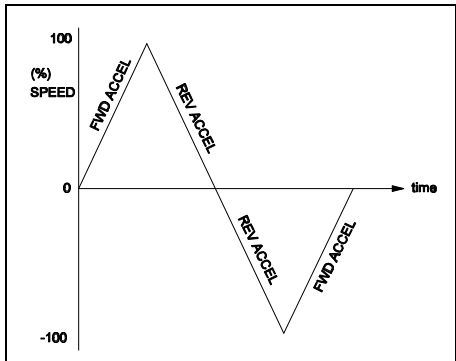
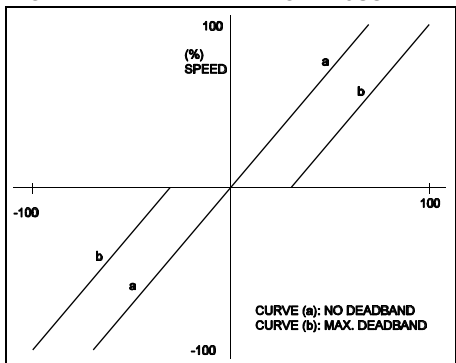

FIG. 17 – DEADBAND TRIMPOT ADJUSTMENT



- B. Deadband Trimpot (DB)** – The DB trimpot sets the amount of main speed potentiometer rotation required to initiate control voltage output. It is factory adjusted to approximately 25% of rotation.

The DB trimpot also determines the amount of delay that will occur before regeneration starts. Regeneration occurs when the applied load torque is in the same direction as the motor rotation.

To readjust the DB to factory setting:

- i. Set Main Speed pot to zero speed position.
- ii. Set DB trimpot to full CCW position.
- iii. Adjust DB trimpot CW until motor hum is eliminated. (See fig. 17, p. 12 for graphic illustration of the DB trimpot.)

Note: If the deadband trimpot is set too low (CCW direction), the motor may oscillate between forward and reverse. Adjust deadband trimpot CW until the instability disappears. (Oscillation may also occur due to RESP and IR COMP trimpot settings. See sec. VII, F p. 14.)

- C. Forward Current Limit (FWD CL) and Reverse Current Limit (REV CL) Trimpots** – These trimpots are used to set the maximum amount of DC current that the motor can draw in both the forward and reverse directions. The amount of DC current determines the amount of maximum motor torque. They are factory set at 150% of the current established by the jumper J3 setting.

Readjust the CL trimpot as follows:

- i. Turn CL trimpot to MIN (CCW) position. Be sure jumper J3 is in the proper position approximately equal to the motor DC ampere rating.
- ii. Wire in a DC ammeter in series with armature lead. Lock shaft of motor.
- iii. Apply power. Rotate CL trimpot quickly until desired CL setting is reached (factory setting is 1.5 times rated motor current). Be sure control is in forward direction for FWD CL trimpot adjustment and likewise with REV CL.

Warning! To prevent motor damage, do not leave motor shaft locked for more than 2 – 3 seconds.

Caution! Adjusting the CL above 150% of motor rating can cause overheating and demagnetization of some PM motors. Consult motor manufacturer.

- D. IR Compensation (IR Comp)** – The IR Comp is used to stabilize motor speed under varying loads.

Readjust the IR Comp trimpot as follows:

- i. Initially set trimpot to factory position (approximately 10 o'clock).
- ii. Run motor at approximately 30 – 50% of rated speed under no load and measure actual speed.
- iii. Load motor to rated current. Rotate IR Comp trimpot so that loaded speed is the same as the unloaded speed measured in the previous step.

Control is now compensated so that minimal speed change will occur over a wide range of motor load. **Note:** Excessive IR Comp will cause unstable (oscillatory) operation.

- E. Maximum Speed (MAX)** – The MAX trimpot is used to set the maximum output voltage of the control which, in turn, sets the maximum speed of the motor.

Adjust the MAX trimpot as follows:

- i. Rotate Main Speed potentiometer to full speed (CW).
- ii. Adjust MAX trimpot to desired maximum motor speed.

Note: Do not exceed maximum rated RPM of motor since unstable operation may result.

F. Response Trimpot (RESP) – This trimpot determines the dynamic response of the control. The factory setting is approximately 50% of full rotation. The setting may be increased if a faster response is required. Note: If response is made too fast, unstable operation may result.

VIII. FUNCTION INDICATOR LAMPS.

A. Power On (PWR ON) – Indicates that the drive is energized with the AC line.

B. Overload (OL) – Indicates the control has reached the current limit set point which has been established by the position of jumper J3 and the FWD CL and REV CL trimpot settings. In transient load applications it is normal for this light to blink.

IX. KBRG-212D ACCESSORIES

- Bipolar Signal Isolator KB P/N 8801
- 4-Quad Accel/Decel KB P/N 8803
- Multi Speed Board KB P/N 8814

IX – LIMITED WARRANTY

For a period of 18 months from date of original purchase, KB will repair or replace without charge devices which our examination proves to be defective in material or workmanship. This warranty is valid if the unit has not been tampered with by unauthorized persons, misused, abused, or improperly installed and has been used in accordance with the instructions and/or ratings supplied. The foregoing is in lieu of any other warranty or guarantee, expressed or implied, and we are not responsible for any expense, including installation and removal, inconvenience, or consequential damage, including injury to any person, caused by items of our manufacture or sale. Some states do not allow certain exclusions or limitations found in this warranty so that they may not apply to you. In any event, KB's total liability, under all circumstances, shall not exceed the full purchase price of this unit. (rev 4/88)



KB ELECTRONICS, INC.

12095 NW 39th Street, Coral Springs, FL 33065 • (954) 346-4900 • Fax (954) 346-3377

Outside Florida Call **TOLL FREE** (800) 221-6570 • **E-mail** – info@kbelectronics.com

www.kbelectronics.com

(A40291) – Rev. B – 8/98