

## F56C1/2M2A

GENERAL PURPOSE ELECTRIC MOTOR  
 HIGH EFFICIENCY / EISA COMPLIANT  
 ROLLED STEEL CONSTRUCTION  
 TOTALLY ENCLOSED FAN COOLED  
 INVERTER RATED (10:1 VT; 5:1 CT)

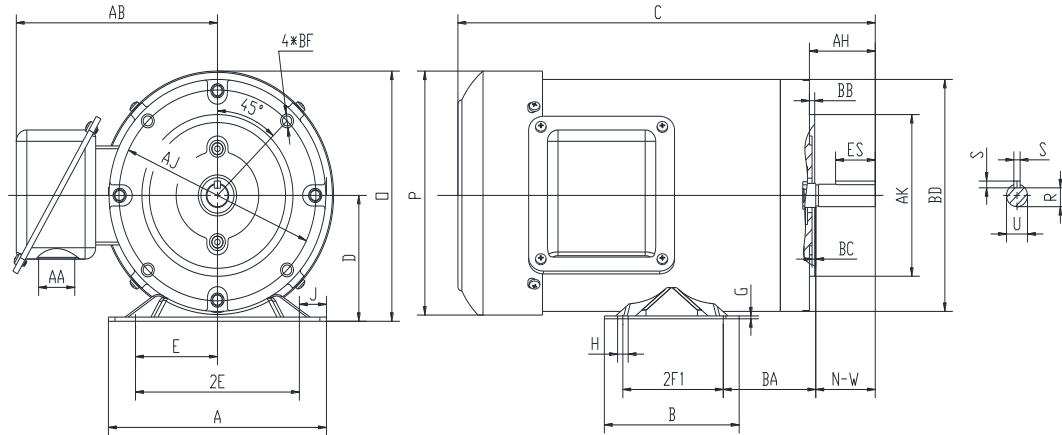

### DIMENSIONS

HP	RPM	Frame	MOUNTING														
			A	B	C	D	G	H	J	E	2E	2F1	2F2	O	P	T	BA
1/2	3600	56C	6.3	4	10.7	3.5	0.12	0.34	0.71	2.44	4.88	3	NA	7	6.8	NA	2.75

FLANGE							Shaft Extension, Key Set						
AH	AJ	AK	BB	BC	BD	BF	U	V	R	S	ES	N-W	
2.06	5.875	4.5	0.16	0.19	6.46	4*3/8-16	0.625	NA	0.517	0.188	1.41	1.88	

Conduit Box		Bearings		Mount
AA	AB	DE	ODE	
1.1	6	6203-2RZC3	6203-2RZC3	F1

**BEARING LUBRICATION:** The bearings come lubricated with Mobil Polyrex EM Polyurea Grease.



## F56C1/2M2A





**GENERAL PURPOSE ELECTRIC MOTOR**  
**HIGH EFFICIENCY / EISA COMPLIANT**  
**ROLLED STEEL CONSTRUCTION**  
**TOTALLY ENCLOSED FAN COOLED**  
**INVERTER RATED (10:1 VT; 5:1 CT)**

### PERFORMANCE DATA

HP	RPM	Frame	Voltage	Frequency (Hz)	Full Load S.F.	Insulation Class	NEMA Design	Slip (%)	NEMA Code	Enclosure Type	IP Rating	Max. Ambient
1/2	3460	56C	208-230/460	60	1.15	F	B	3.9	L	TEFC	55	40 °C

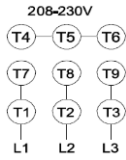
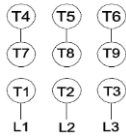
Amps (460V)		Efficiency (%)			Power Factor			Torque (ft-lb)			DE Bearing	ODE Bearing	Connection	Weight (lbs.)
FLA	LRA	100%	75%	50%	100%	75%	50%	FLT	LRT %	BDT %				
0.84	5.37	71.6	68.6	60.1	0.79	0.73	0.63	0.77	386	397	6203-2RZC3	6203-2RZC3	9 Lead 2Y/Y	18

### NAME PLATE

		THREE PHASE AC INDUCTION MOTOR											
CAT NO: F56C1/2M2A		FRAME	56C	PH	3								
HZ	60	S.F.	1.15	ENCL	TEFC							IP	55
HP	1/2	RPM	3460	DUTY	CONT							DES	B
VOLT		208-230/460		AMB	40 °C	INS	F						
FLA	1.74-1.68/0.84		DE BRG	6203-2RZC3									
CODE	L	P.F.	0.79	ODE BRG	6203-2RZC3								
EFF	71.6	MIN	53.0	LBS	18								
CONNECTION		9 Lead 2Y/Y		SER NO.									
Hernando, MS <a href="http://www.naemotors.com">www.naemotors.com</a>													

### APPLICATIONS:

General purpose use on pumps, fans, blowers, compressors, conveyors, material handling and other industrial machinery installed in damp, dusty or dirty environments.