



## Signal Isolator SIMG (Part No. 8832) Installation and Wiring Instructions for Model KBMG with 2-Piece Finger-Safe Cover

This document is supplied with Model KBMG only.



**Warning!** Before installing the SIMG onto the KBMG, the AC power must be disconnected.

The following Installation and Wiring instructions are to be used as a supplement to the KBMG Installation and Operating Instructions Manual (Part No. A40263). Refer to the SIMG Installation and Operating Instructions Manual (Part No. A40269) for specific and external signal following connections. See Figures 1 - 5, on page 2.

**Tools required for installation: small flat blade screwdriver, long nose pliers, cutters.**

**Notes:** 1. To install the SIMG, be sure the Top Panel of the KBMG 2-Piece Finger-Safe Cover (FSC) is not installed. 2. All trimpots and jumpers, on the KBMG, must be set before installing the SIMG.

### 1 Preparing the KBMG Prior to Installing the SIMG - See Figure 1.

- 1.1 Insert the flat blade screwdriver between the KBMG PC Board and Terminal Block TB1 and gently pry it off. Discard the Terminal Block.

**Note:** When prying off the Terminal Block, care should be taken to not scratch circuit traces that are on the PC Board surface.

- 1.2 Using a flat blade (or Phillips) screwdriver, remove the screw from the KBMG FSC. Retain this screw for use in Section 3.3, below.
- 1.3 Using long nose pliers, remove and discard the Terminal Boots that are factory installed on Terminals "F-" and "F+" on the KBMG.

### 2 Preparing the SIMG for Installation onto the KBMG - See Figure 2.

**Note:** If the SIMG does not contain a Ring Lug and Cable Tie, proceed to paragraph 3 below.

- 2.1 Using long nose pliers, carefully uncurl the Ring Lug off the Cable Assembly.
- 2.2 Using cutters, carefully remove the Cable Tie from the SIMG.
- 2.3 Discard the Ring Lug and Cable Tie.

### 3 Installing the SIMG onto the KBMG - See Figure 3.

- 3.1 Align and gently push the Terminal Block on the SIMG onto the Terminal Block Header on the KBMG.
- 3.2 Align the (3) Holes on the SIMG with the (3) Snap Posts on the KBMG FSC. Gently press the SIMG Board onto the (3) Snap Posts. Apply pressure at each Snap Post.
- 3.3 Install the Screw, that was removed in Section 1.2, and gently tighten it to secure the SIMG onto the KBMG FSC. Do not overtighten.

### 4 Wiring the SIMG After Installed onto the KBMG - See Figures 4 and 5.

**Note:** On older SIMG models, the Brown and Yellow Wires must be crisscrossed, as shown in Figure 3. On newer SIMG models, the Brown and Yellow Wires are not crisscrossed.

- 4.1 Carefully insert the Cable Assembly through the Retainer Clip on the KBMG FSC.
- 4.2 Connect the Brown Wire (larger terminal) to Terminal F- on the KBMG.
- 4.3 Connect the Yellow Wire (smaller terminal) to Terminal F+ on the KBMG.

### 5 Installing the SIMG Finger-Safe Cover - See Figure 3.

Align the (4) Snap Tabs on the SIMG FSC with the (4) slots on the KBMG FSC. The Cable Shroud must be positioned over the Cable Assembly (Brown and Yellow Wires). Apply pressure to snap the cover into position.

**Note:** Be sure that the Cable Assembly is centered in the Retaining Clip so the wires are not damaged by the Cable Shroud.

**The SIMG Installation is now complete.**



### Signal Isolator SIMG (Part No. 8832) Installation and Wiring Instructions for Model KBMG with 2-Piece Finger-Safe Cover

Figure 1 - Preparing the KBMG Prior to Installing the SIMG

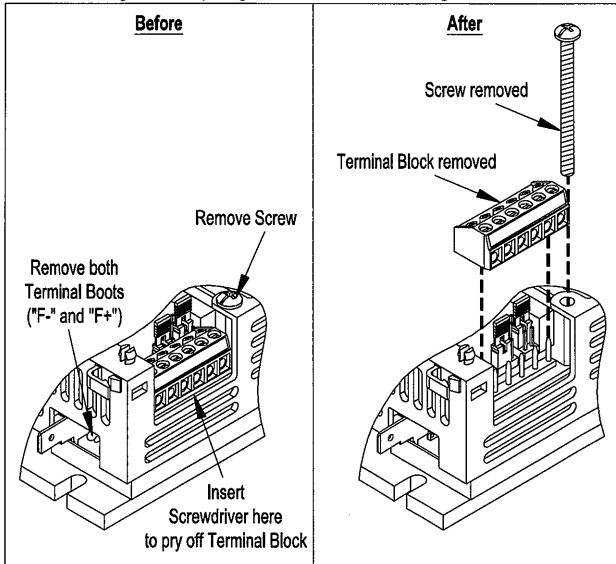


Figure 2 - Preparing the SIMG for Installation onto the KBMG

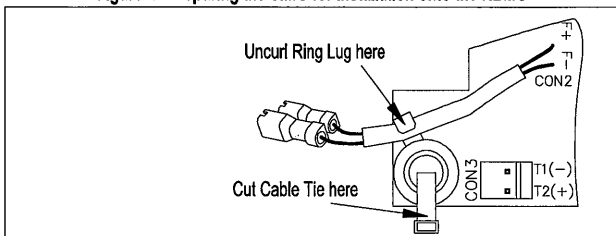


Figure 4 - Wiring the SIMG After Installed onto the KBMG

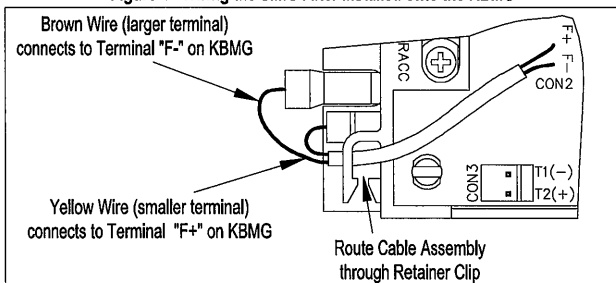


Figure 5 - View of KBMG Terminals "F-" and "F+"

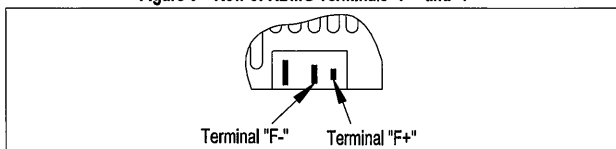
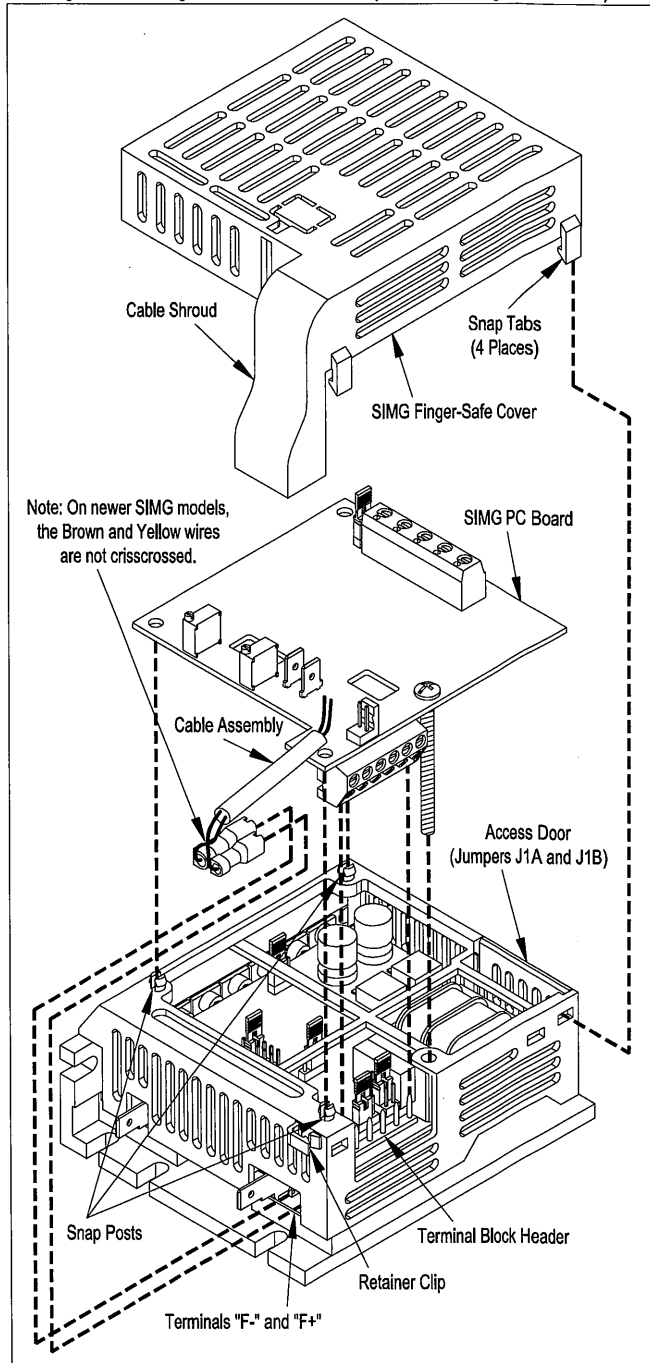


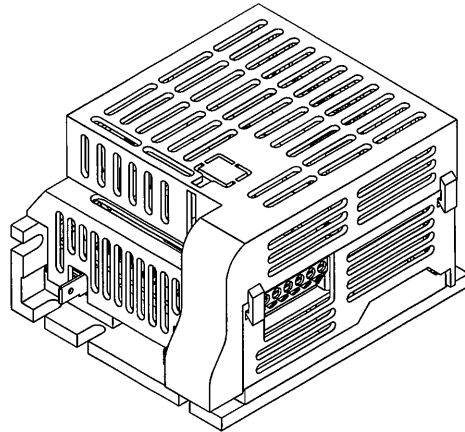
Figure 3 - Installing the SIMG onto the KBMG (with 2-Piece Finger-Safe Cover)



# INSTALLATION AND OPERATING INSTRUCTIONS

## MODEL SIMG

KB Part No. 8832 — Signal Isolator for KBMG-212D Regenerative Drive



 See Safety Warning on Page 1

The information contained in this manual is intended to be accurate. However, the Manufacturer retains the right to make changes in design which may not be included herein.

**PENTA  POWER™**

A COMPLETE LINE OF MOTOR DRIVES

© 2000 KB Electronics, Inc.

### TABLE OF CONTENTS

<u>Section</u>	<u>Page</u>
i. Safety Warning .....	1
I. Introduction .....	2
II. Installation Instructions .....	6
III. Connections to the SIMG .....	12
IV. Calibration Procedure .....	16
V. Installing the SIMG Finger-Safe Cover .....	17
VI. Limited Warranty .....	18
<b>Tables</b>	
1. General Performance Specifications .....	6
2. Terminal Block Wiring Information .....	12
3. Resistor for Signal Following from Armature Voltage .....	14
<b>Figures</b>	
1. Control Layout .....	3
2A. Mechanical Specifications .....	4
2B. Mechanical Specifications (Continued) .....	5
3. KBMG/SIMG Assembly Diagram .....	7
4. Removing the KBMG Finger-Safe Cover .....	8
5. Removing Terminal Block TB1 .....	9
6. Removing the KBMG Finger-Safe Cover Panel .....	9
7. Removing the KBMG Finger-Safe Cover Field Tab .....	9
8. Connection Diagram .....	10
9. Installing Field Connector .....	11
10. Voltage Following Connection .....	12
11. Main Speed Potentiometer Connections .....	13
12. Signal Following from Armature Voltage .....	14
13. Enable Switch Connection .....	16
14. Removing The SIMG Finger Safe Cover Field Tab .....	17

 **SAFETY WARNING! Please read carefully.**

Be sure to follow all instructions carefully. Fire and/or electrocution can result due to improper use of this product.

This product should be installed and serviced by a qualified technician, electrician, or electrical maintenance person familiar with its operation and the hazard involved. Proper installation, which includes wiring, mounting in proper enclosure, fusing or other over-current protection and grounding, can reduce the chance of electric shocks, fires, or explosion in this product or products used with this product, such as electric motors, switches, coils, solenoids, and relays. Eye protection must be worn and insulated adjustment tools must be used when working with control under power. This product is constructed of materials (plastics, metals, carbon, silicon, etc.) which may be a potential hazard. Proper shielding, grounding, and filtering of this product can reduce the emission of radio frequency interference (RFI) which may adversely affect sensitive electronic equipment. If information is required on this product, contact our factory. It is the responsibility of the equipment manufacturer and individual installer to supply this safety warning to the ultimate user of this product. (SW effective 11/92)

This control contains electronic start/stop and enable circuits that can be used to start and stop the control. However, these circuits are never to be used as safety disconnects since they are not fail safe. Use only the AC line for this purpose.



This product complies with all CE directives pertinent at the time of manufacture. Contact factory for detailed installation instructions and Declaration of Conformity.

1

## I. INTRODUCTION

Thank you for purchasing the SIMG Bipolar Signal Isolator (P/N 8832). KB Electronics, Inc. is committed to providing total customer satisfaction by producing quality products that are easy to install and operate. The SIMG is manufactured with surface mount components incorporating advanced circuitry and technology.

The SIMG provides input isolation and is used to isolate, amplify, and condition DC voltage signals from any external source (power supplies, motors, tachometer generators, transducers, and potentiometers). The isolated output voltage of the SIMG provides input signals to the KBMG-212D (hereinafter referred to as KBMG) Regenerative Drive (P/N 8831). It also provides isolation for motor direction switching and an isolated power supply for transducer or potentiometer operation. The PWR LED provides indication that power is applied.

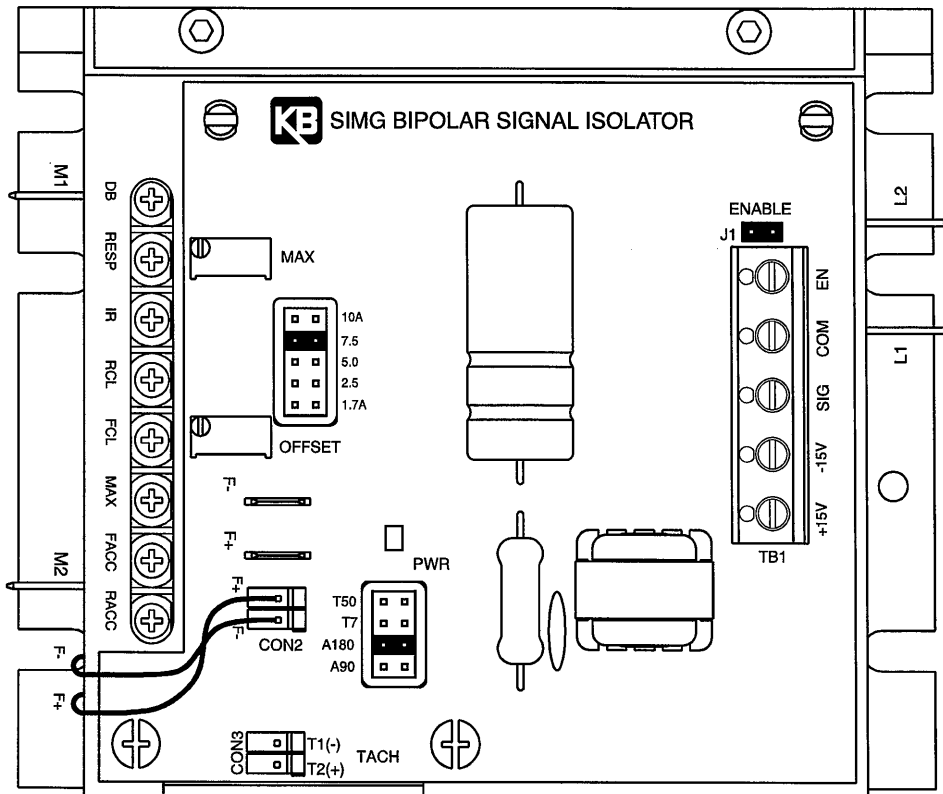
All input connections (+15, -15, SIG, COM, and EN) are made via a barrier terminal block and are isolated from AC line and motor wiring.

The SIMG is factory calibrated to accept a signal input voltage of -10V to +10V DC. OFFSET and MAX trimpots are provided in order to recalibrate the SIMG for specific applications.

2

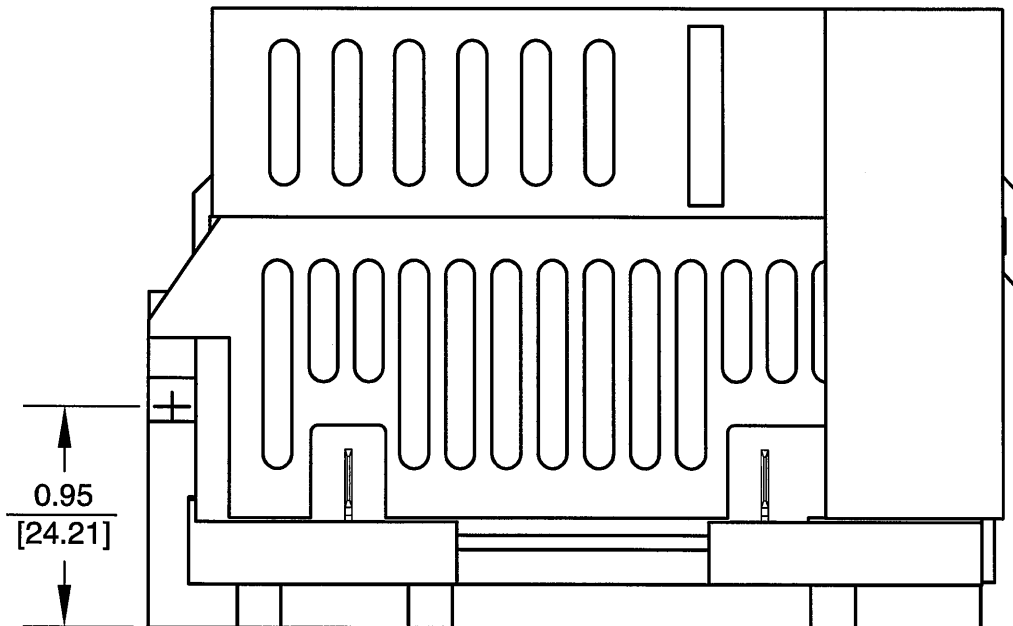
**FIGURE 1 – CONTROL LAYOUT**

(Illustrates Factory Setting of Jumpers and Approximate Trimpot Settings)



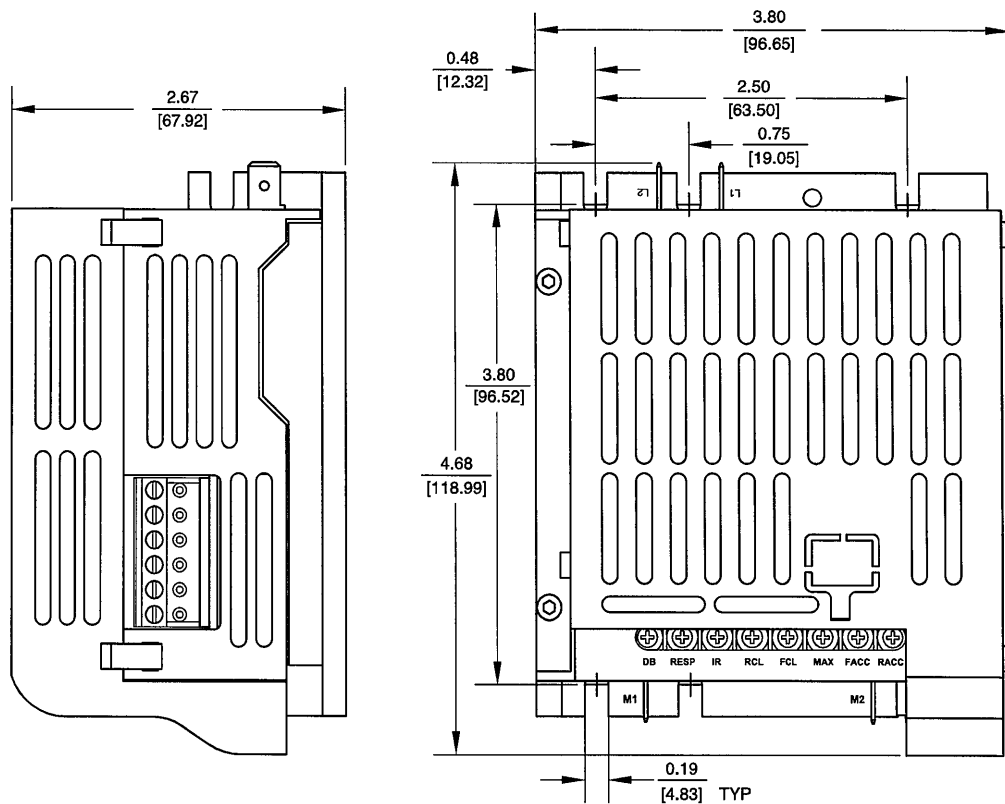
3

**FIGURE 2A – MECHANICAL SPECIFICATIONS (INCHES / mm)**  
(Shown Mounted onto KBMG)



4

**FIGURE 2B – MECHANICAL SPECIFICATIONS (INCHES / mm)**  
(Shown Mounted onto KBMG)



5

**TABLE 1 – GENERAL PERFORMANCE SPECIFICATIONS**

Parameter	Specification	Factory Setting
Voltage Following Input Range (V DC)	± 5 to ± 25	-10 to +10
Potentiometer Operation (kΩ)	5	—
OFFSET Trimpot Range (with 0V DC Input) (% Speed)	± 50	0
MAX Trimpot Range (with 10V DC Input) (% Speed)	0 – 110	100
+15V DC and -15V DC Power Supply Max. Current Rating (mA DC)	25	—
Forward, Reverse, and Enable Input Switch Types	Dry Contact or Open Collector	—
Input/Output Linearity (%)	0.1	—
Thermal Drift (mV/ °C)	0.4	—
Ambient Operating Temperature Range (°C)	0 – 50	—

**II. INSTALLATION INSTRUCTIONS: Mounting the SIMG onto the KBMG**

See figure 3 on page 7. **Note:** This figure is also supplied as a separate drawing.



**Warning!** Make sure all power is disconnected from the KBMG before proceeding.

**A. Removing the KBMG Finger-Safe Cover**

If a finger-safe cover is not installed on the KBMG, proceed to section IIC (Modifying the KBMG Finger-Safe cover). If a finger-safe cover is installed on the KBMG, remove the two (2) socket head 5-40 X 5/16" screws located at the rear of the KBMG using the supplied 3/32" hex key. Also, remove the two (2) 6-32 X 1-3/4" screws located on either side of terminal block TB1. See figure 4 on page 8.

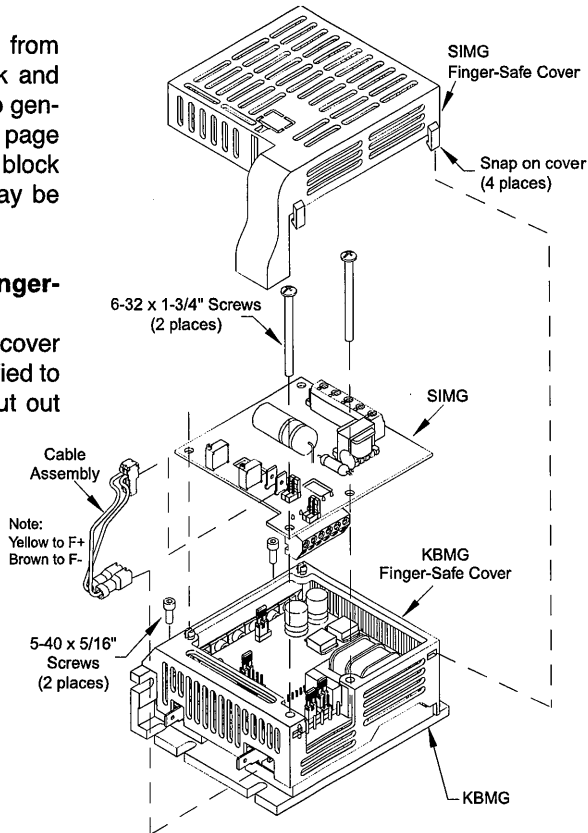
**B. Removing Terminal Block TB1 from the KBMG**

Remove terminal block TB1 from the KBMG by rocking it back and forth or using a screwdriver to gently pry it off. See figure 5 on page 9. The removed terminal block TB1 will not be used and may be discarded.

**C. Modifying the KBMG Finger-Safe Cover**

Once the KBMG finger-safe cover is removed, it has to be modified to accommodate the SIMG. Cut out the finger-safe cover panel at seven (7) places as shown in figure 6 on page 9. (Note: Some finger-safe covers may already have the panel removed.) To access the field terminals (F+ and F- on the KBMG) cut out the field tab of the KBMG finger-safe cover at three (3) places as shown in figure 7 on page 9.

**FIGURE 3 – KBMG/SIMG ASSEMBLY DIAGRAM**



**D. Installing the KBMG Finger-Safe Cover**

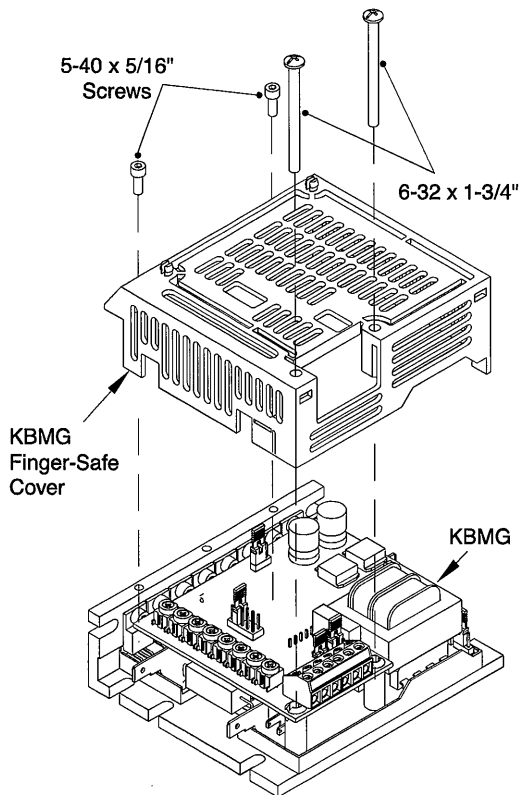
Once the KBMG finger-safe cover has been modified, it can be installed onto the KBMG. Initially, use only the two (2) 5-40 X 5/16\" socket head screws, using the supplied 3/32\" hex key. Do not over tighten these screws or damage may result to the KBMG finger-safe cover.

**Note: All jumpers on the KBMG must be set to their appropriate positions before installing the KBMG finger-safe cover.**

**E. Installing the SIMG onto the KBMG**

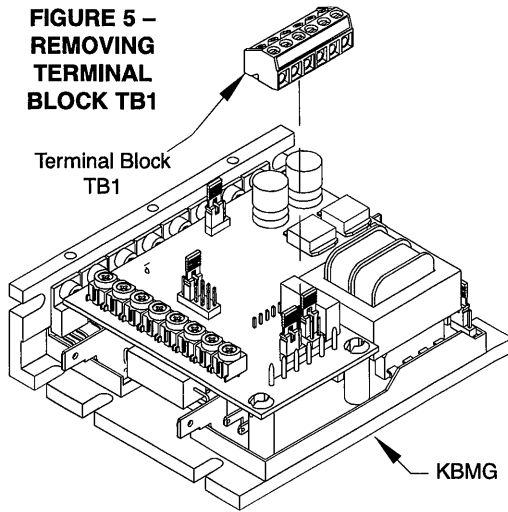
The terminal block located on the bottom of the SIMG plugs onto the six (6) header pins where TB1 was removed from the KBMG. The two holes on the back of the SIMG snap onto the finger-safe cover.

**FIGURE 4 – REMOVING THE KBMG FINGER-SAFE COVER**

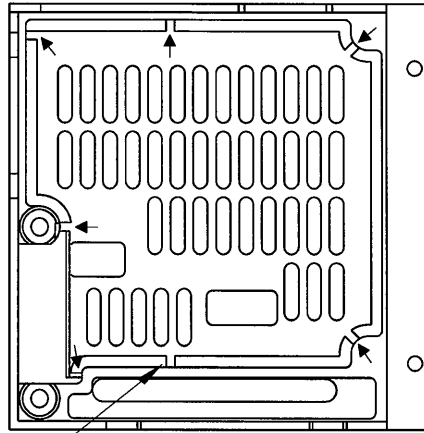


Use the two (2) 6-32 X 1-3/4" screws previously removed to secure the SIMG to the KBMG. Do not over tighten these screws or damage may result to the SIMG and KBMG. See figure 3 on page 7.

**FIGURE 5 – REMOVING TERMINAL BLOCK TB1**

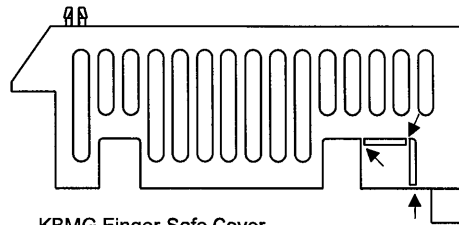


**FIGURE 6 – REMOVING THE KBMG FINGER-SAFE COVER PANEL**



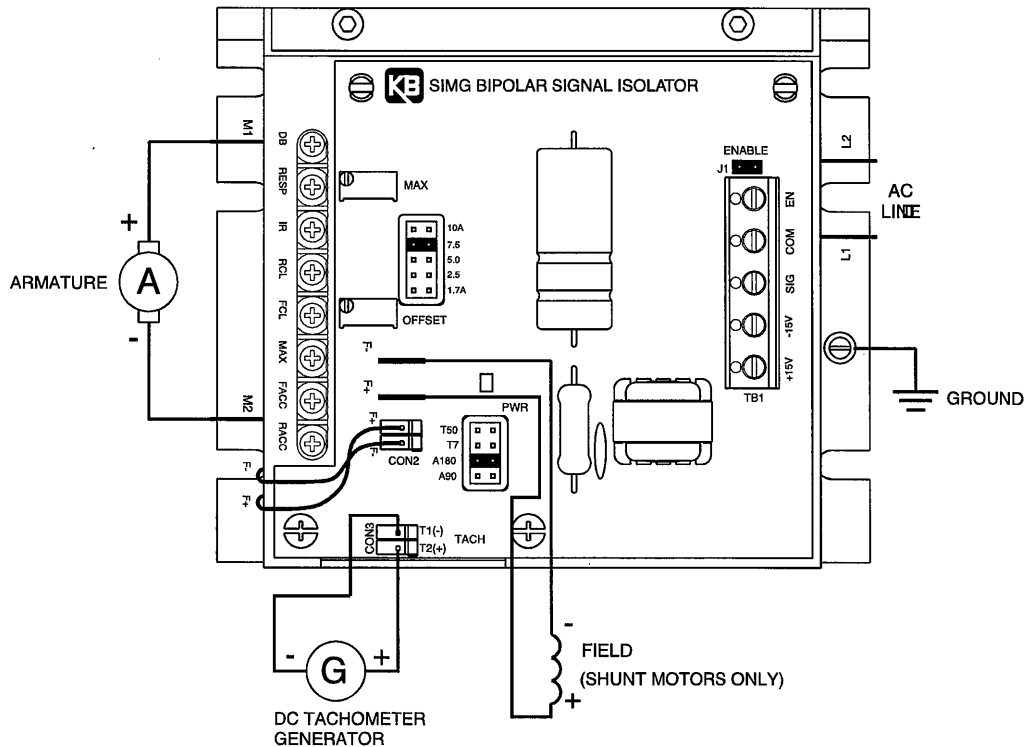
KBMG Finger-Safe Cover  
Remove Panel (cut 7 places) to Install SIMG.

**FIGURE 7 – REMOVING THE KBMG FINGER-SAFE FIELD TAB**



KBMG Finger-Safe Cover  
Remove Tab (cut 3 places) to Access Field Terminals.

**FIGURE 8 – CONNECTION DIAGRAM**



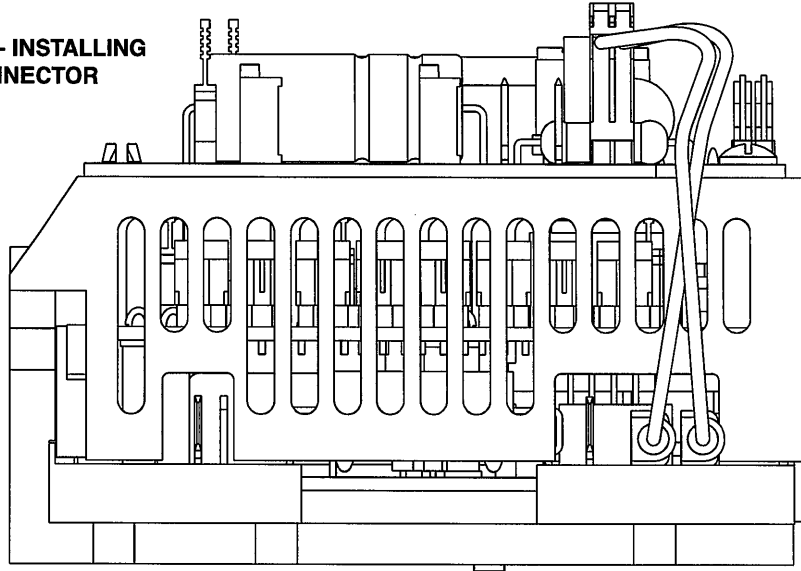


**F. Wiring the SIMG to the KBMG**

See figure 8 on page 10.

The SIMG is powered from the KBMG with a connector that is installed from the SIMG CON2 to the KBMG F+ and F- terminals. The yellow wire connects to the KBMG F+ terminal and the brown wire connects to the KBMG F- terminal. When the field connector is properly installed the wires should cross over each other. See figure 9. If the connector is wired incorrectly, the SIMG PWR LED will not illuminate and the control will not operate. **Note:** It is recommended that these wires be twisted at least three (3) times to help reduce noise.

**FIGURE 9 – INSTALLING FIELD CONNECTOR**



11

**III. Connections to the SIMG**

**⚠ Safety Warning!** Do not use FWD-STOP-REV contacts as a safety disconnect since they are not fail-safe. Use only the AC line for this purpose.

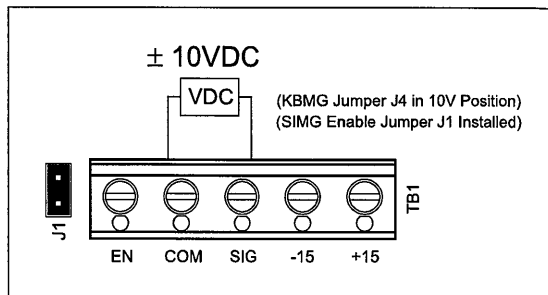
**Note:** SIMG Enable jumper J1 must be installed, or a connection must be made between EN and COM terminals of SIMG TB1 in order for the KBMG to operate.

**TABLE 2 – TERMINAL BLOCK (TB1) WIRING INFORMATION**

Connection Designation	Supply Wire Gauge (AWG – Cu)		Maximum Tightening Torque (in-lbs)
	Minimum	Maximum	
Logic Connections	24	14	3.5

**A. Voltage Following** – Uses a voltage source to vary motor speed. See figure 10. Connect the voltage source to TB1 terminals SIG and COM. When a 0V DC signal is applied, the control will operate at the minimum set speed (set by the OFFSET trimpot on the SIMG). When a 10V DC signal is applied, the motor will operate at the maximum set speed (set by the MAX trimpot on the SIMG).

**FIGURE 10 – VOLTAGE FOLLOWING CONNECTION**

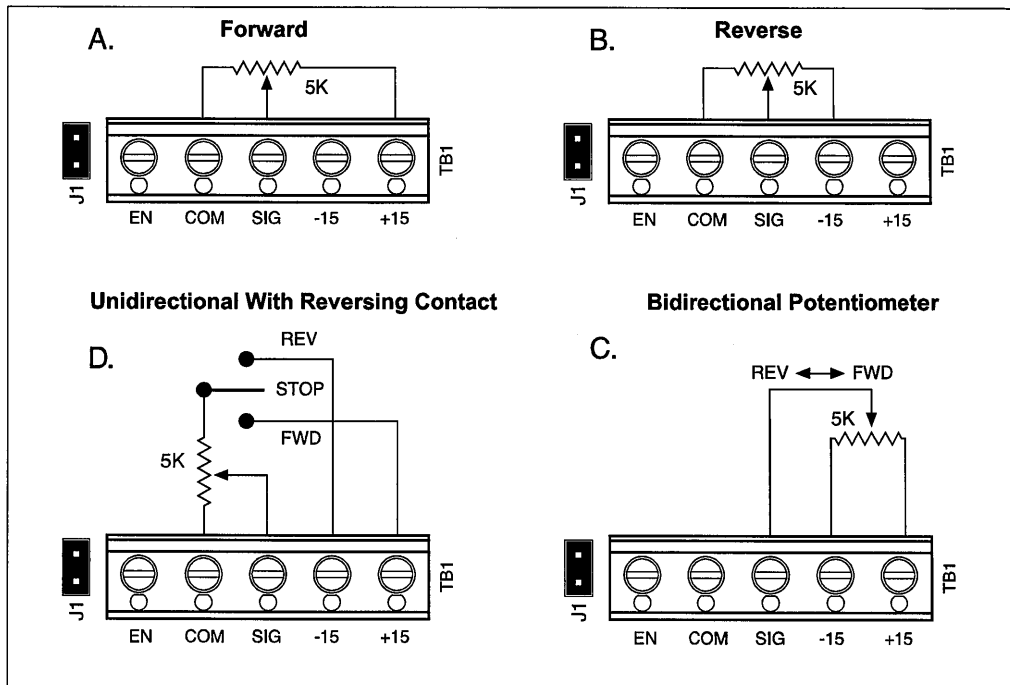


Applying a positive (+) signal to SIG terminal, with respect to COM terminal, will operate the motor in the forward direction.

Applying a negative (-) signal to SIG terminal, with respect to COM terminal, will operate the motor in the reverse direction.

**FIGURE 11 – MAIN SPEED POTENTIOMETER CONNECTIONS**

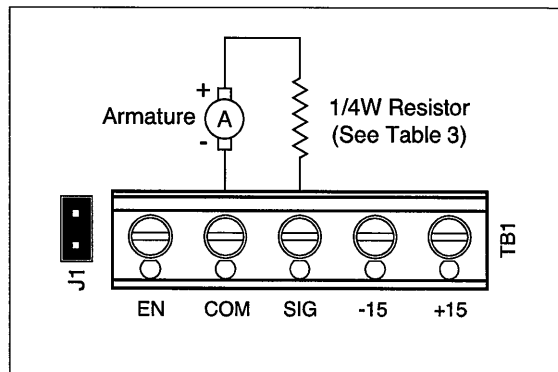
(KBMG Jumper J4 in 15V Position, SIMG Enable Jumper J1 Installed)



13

**B. Signal Following from Armature Voltage** – Uses motor armature voltage as a signal input. If the signal input voltage applied to the SIMG is derived from a motor armature voltage output, it is necessary to install a 1/4W resistor in series with the signal lead into the SIMG. For a 90V DC motor, install a 150K resistor. for a 180V DC motor, install a 330K resistor.

**FIGURE 12 – SIGNAL FOLLOWING FROM ARMATURE VOLTAGE**



**C. Unidirectional Potentiometer Operation (Forward)** – Uses a potentiometer to vary motor speed. See figure 11A on page 13. Connect the 5K potentiometer to TB1 terminals marked “SIG” (wiper of potentiometer), “+15V” (high side of potentiometer), and “COM” (low side of potentiometer). Use the potentiometer to vary motor speed. If the motor is not running in the desired direction, either reconnect the high side of the potentiometer to TB1 terminal marked “-15V” or reverse the motor leads.

**TABLE 3 – RESISTOR FOR SIGNAL FOLLOWING FROM ARMATURE VOLTAGE**

Armature Voltage Range (VDC)	1/4W Resistor (Ω)
0 – ± 90	150K
0 – ± 180	330K


**D. Unidirectional Potentiometer Operation (Reverse)** – Uses a potentiometer to vary motor speed. See figure 11B on page 13. Connect the 5K potentiometer to TB1 terminals marked “SIG” (wiper of potentiometer), “-15V” (high side of potentiometer), and “COM” (low side of potentiometer). Use the potentiometer to vary motor speed and the switching device to select motor direction. If the motor is not running in the desired direction, either reconnect the high side of the potentiometer to TB1 terminal marked “+15V” or reverse the motor leads.

**E. Bidirectional Potentiometer Operation** – Uses a potentiometer to vary motor speed and direction. See figure 11C on page 13. Connect the 5K potentiometer to TB1 terminals marked “SIG” (wiper of potentiometer), “+15V” (high side of potentiometer), and “-15V” (low side of potentiometer). Use the potentiometer to vary motor speed and direction.

When the potentiometer is in the center position, the control output can be set to zero, using the OFFSET trimpot. Rotating the trimpot clockwise will cause the motor to rotate in the forward direction. Rotating the potentiometer counterclockwise will cause the motor to rotate in the reverse direction.

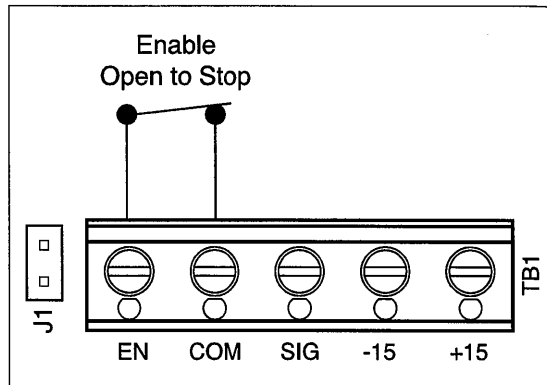
**F. Unidirectional Potentiometer with Reversing Contacts** – Uses a potentiometer to vary motor speed. See figure 11D on page 13. Connect the 5K potentiometer to TB1 terminals marked “SIG” (wiper of potentiometer), “+15V” (high side of potentiometer), and “COM” (low side of potentiometer). Use the potentiometer to vary motor speed and the switching device to select motor direction. When the potentiometer is set to 0% (fully counterclockwise), the motor will operate at the minimum set speed (set by the OFFSET trimpot on the SIMG). When the potentiometer is set to 100% (fully clockwise) the motor will operate at full speed (set by the MAX trimpot on the SIMG).

**G. Enable Switch Connection**

 **Safety Warning!** Do not use Enable or Start/Stop contacts as a safety disconnect since they are not fail-safe. Use only the AC line for this purpose. See figure 13.

If a Start/Stop function is required, remove SIMG Enable jumper J1 and wire a switch to EN and COM terminals of SIMG TB1. When the switch is opened, the control will stop. When the switch is closed, the control will operate.

**FIGURE 13 – ENABLE SWITCH CONNECTION**  
(SIMG Enable Jumper J1 Removed)



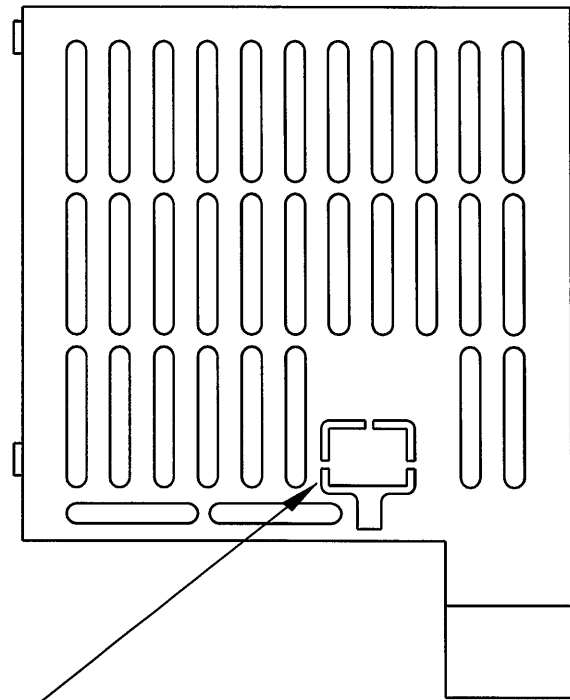
**H. Tachometer Generator Connection**

See figure 8 on page 10. To wire a 7V or 50V per 1000RPM tachometer generator to the SIMG, connect the positive (+) side of the tachometer generator to terminal “T2” and the negative (-) side of the tachometer generator to terminal “T1” of the SIMG. **Note:** If the positive (+) and negative (-) tachometer generator connections are not connected as described above, the motor will run at full speed only.

**I. Motor Field Connection**

If a shunt wound motor is used, the motor field wires connect to F+ and F- terminals on the SIMG. To access these terminals, cut out the field tab of the SIMG finger-safe cover at three (3) places as shown in figure 14 on page 17.

**FIGURE 14 – REMOVING THE SIMG FINGER-SAFE COVER FIELD TAB**



SIMG Finger-Safe Cover  
Cut Out Tab (3 Places) to Access Field Terminals.  
(For Shunt Wound Motors Only.)

17

#### **IV. CALIBRATION PROCEDURE**

(See **Safety Warning**, on page 1)

The SIMG is factory calibrated, but readjustments to the OFFSET and MAX trim pots can be made to customize for a particular signal input requirement. It may be necessary to repeat the calibration steps to achieve accurate settings.

##### **A. Unidirectional Voltage Following Calibration**

See figure 10 on page 12.

1. Apply 0V DC input signal (or connect SIG and COM terminals).
2. Monitor the KBMG output and adjust the OFFSET trim pot on the SIMG for the desired minimum setting.
3. Apply the maximum voltage input signal.
4. Monitor the KBMG output voltage and adjust the MAX trim pot on the SIMG for the desired maximum setting.

##### **B. Unidirectional Potentiometer Operation Calibration:**

See figure 11A, B or C on page 13.

1. Set potentiometer to 0% rotation (fully counterclockwise).
2. Monitor the KBMG output and adjust the OFFSET trim pot on the SIMG for the desired minimum setting.
3. Set potentiometer to 100% rotation (fully clockwise).
4. Monitor the KBMG output voltage and adjust the MAX trim pot on the SIMG for the desired maximum setting.

**V. INSTALLING the SIMG FINGER-SAFE COVER**

After all adjustments and wiring have been completed on the KBMG and the SIMG, install the SIMG finger-safe cover onto the KBMG finger-safe cover by snapping the four (4) clips of the SIMG finger-safe cover into the four (4) slots of the KBMG finger-safe cover.

**Note:** Ensure that the yellow and brown field wires (from CON2 of the SIMG to F+ and F- terminals of the KBMG) are within the shroud of the SIMG finger-safe cover. See figure 3 on page 7.

**VI. LIMITED WARRANTY**

For a period of 18 months from the date of original purchase, KB Electronics, Inc. will repair or replace, without charge, devices which our examination proves to be defective in material or workmanship. This warranty is valid if the unit has not been tampered with by unauthorized persons, misused, abused, or improperly installed and has been used in accordance with the instructions and/or ratings supplied. The foregoing is in lieu of any other warranty or guarantee, expressed or implied. KB Electronics, Inc. is not responsible for any expense, including installation and removal, inconvenience, or consequential damage, including injury to any person, caused by items of our manufacture or sale. Some states do not allow certain exclusions or limitations found in this warranty and therefore they may not apply to you. In any event, the total liability of KB Electronics, Inc. under any circumstance, shall not exceed the full purchase price of this product.

(Rev. 2/2000)



**KB Electronics, Inc.**

12095 NW 39th Street, Coral Springs, FL 33065-2516 • (954) 346-4900 • Fax (954) 346-3377  
Outside Florida Call TOLL FREE (800) 221-6570 • E-mail – info@kbelectronics.com  
www.kbelectronics.com