

Trim size 4.5 x 6.875 in.
Spread size 9 x 6.875 in.

PROPEL

PROPEL

ZIP™ MICRO DRONE INDOOR / OUTDOOR WIRELESS QUADROPTER



INDUSTRY CANADA NOTICE: CANADA ONLY.

This device complies with Industry Canada licence-exempt RSS standard(s). Operation is subject to the following two conditions: (1) this device may not cause interference, and (2) this device must accept any interference, including interference that may cause undesired operation of the device.

Le présent appareil est conforme aux CNR d'Industrie Canada applicables aux appareils radio exempts de licence. L'exploitation est autorisée aux deux conditions suivantes : (1) l'appareil ne doit pas produire de brouillage, et (2) l'utilisateur de l'appareil doit accepter tout brouillage radioélectrique subi, même si le brouillage est susceptible d'en compromettre le fonctionnement.

Under Industry Canada regulations, this radio transmitter may only operate using an antenna of a type and maximum (or lesser) gain approved for the transmitter by Industry Canada. To reduce potential radio interference to other users, the antenna type and its gain should be so chosen that the equivalent isotropically radiated power (e.i.r.p.) is not more than that necessary for successful communication.

Conformément à la réglementation d'Industrie Canada, le présent émetteur radio peut fonctionner avec une antenne d'un type et d'un gain maximal (ou inférieur) approuvé pour l'émetteur par Industrie Canada. Dans le but de réduire les risques de brouillage radioélectrique à l'intention des autres utilisateurs, il faut choisir le type d'antenne et son gain de sorte que la puissance isotrope rayonnée équivalente (p.i.r.e.) ne dépasse pas l'intensité nécessaire à l'établissement d'une communication satisfaisante.



Conforms to safety requirements of ASTM, CPSIA and FCC.

©2015 Rooftop Brands™ All rights reserved
Tel: + (1) 949-566-9573 • www.propelrc.com

Made in China

INSTRUCTION BOOKLET

WARNING: Never leave product charging unattended for extended periods of time. Always disconnect the ZIP™ from charger immediately after it is fully charged. Please refer to enclosed safety instructions.

PACKAGE CONTAINS:



ZIP™



2.4G Wireless Controller



Spare Parts



USB charging cord



Instruction Manual

Colors and styles may slightly vary.



TABLE OF CONTENTS

Product Features	2
Remote Control Battery Installation	2
Charging Your ZIP™ Battery	2
ZIP™ Diagram	3
Remote Control Diagram	3
Synching Your ZIP™	4
Flight Preperation	4
Flying Tips	4
Recognizing The Front & Back Of The ZIP™	5
Basic Flight Control	5
Understanding Trim Adjustments	6
Level Surface Gyro Calibration	6
Low Battery Warning	6
Switching To High Speed Mode	7
Performing A 360° Stunt Roll	7
Trouble Shooting	8
Replacing The Propeller Blades	8
Warnings	9
Battery Warnings	9
Care and Maintenance	9
FCC Information	10

Thank you for purchasing the ZIP™ 2.4 Ghz Mini Quadcopter. Please read this instruction booklet as it contains valuable information on how to properly fly and care for your ZIP™ Drone.

FEATURES

- 4 channel flight controls allow for incredible maneuverability including 360° arial stunts!
- Built-in 6 axis gyro chip for extremely stable flight.
- 2.4 Ghz digital technology allows for flight range up to 100 feet.

REMOTE CONTROL BATTERY INSTALLATION

1. Unscrew the battery cover from the back of the controller as shown in diagram A.
2. Install 2"AA" alkaline batteries into the controller as shown in diagram B.
3. Replace the battery cover.
4. Turn over the controller and turn the on/off switch to the ON position the red LED will flash if batteries are installed correctly.

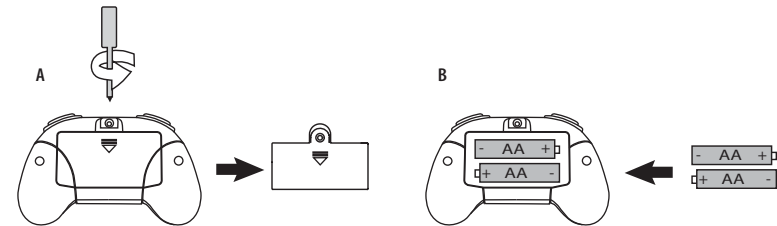

CHARGING YOUR ZIP™ BATTERY

1. Switch the quadcopter Off. Connect the power cable to the unit making sure the arrow side of the connector is on top side facing the top of the ZIP™ (see diagrams C1 and C2).
CAUTION: The USB plug fits the charging socket only in one way. Do not force it. Improper connection will damage the ZIP™.
2. Connect the USB end of the cable to your computers USB port (see diagram D).
3. The red LED on the USB plug lights up when charging is complete. Average charging time is 30 minutes.
Note: If the red LED lights up, either the charging is complete or the USB plug is not properly connected.
A full charge will allow for about 5 minutes of flight time depending on environment and user input.

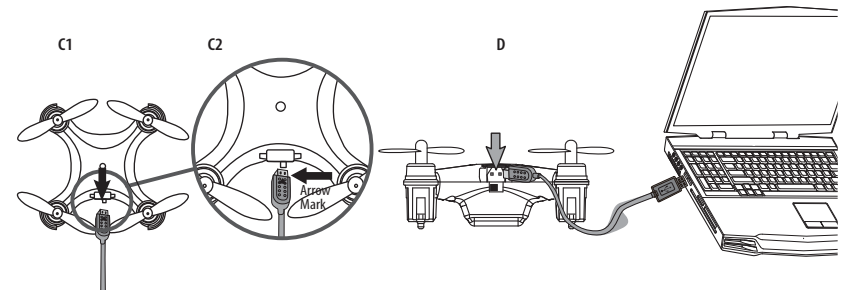

IMPORTANT: ALWAYS REMEMBER TO UNPLUG YOUR CHARGING CORD WHEN NOT IN USE!

ZIP™ DIAGRAM

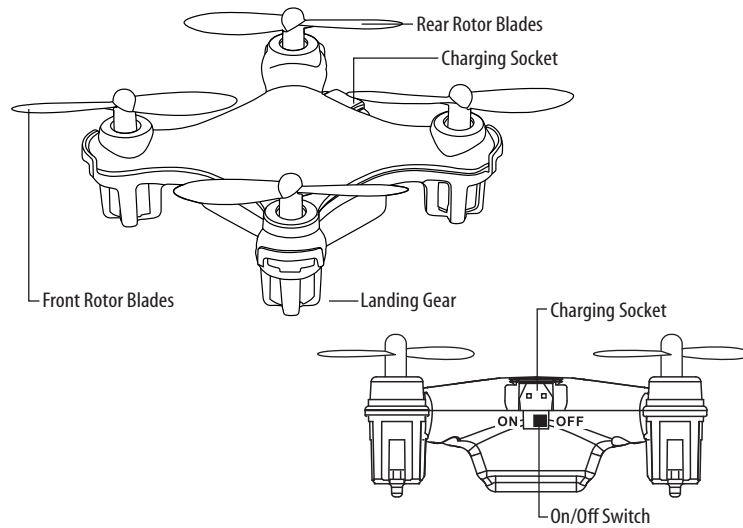

ZIP™ REMOTE DIAGRAM

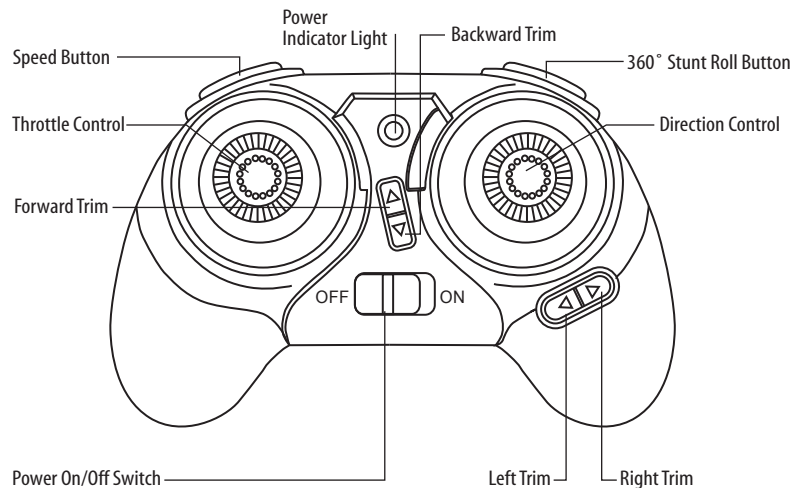

WARNING

DO NOT FLY YOUR ZIP™ IN FOUL WEATHER!



SYNCING YOUR ZIP™

Important! When syncing your ZIP™ quadcopter with the controller always make sure that the quadcopter is on a flat level surface and that your digital trim settings are in the center position. This ensures that the 6 Axis gyro is properly programmed to mimic your trim settings.

Your ZIP™ utilizes an automatic 2.4G channel selection system that allows up to 8 people to fly side by side in the same wireless range with no interference.

For One-Person Play:

1. Before starting, make sure that the power on both your controller and ZIP™ are in the OFF position. Make sure that there are no other 2.4G devices in the area as well.
2. Turn ON the ZIP™ and set it down on a flat surface. The LED indicator lights of the ZIP™ should begin to flash rapidly.
3. Turn ON the remote, you will hear two beeps. The ZIP's LED lights should now flash slowly. Push the throttle on the left all the way forward (1 beep) and then pull the throttle all the way back. A 2nd beep will sound and the lights should turn to solid. This indicates your controller and the quadcopter are successfully synced. If not, repeat above steps.

For Multi Person Play:

4. Before starting, make sure that the power on all ZIP™ drones and Controllers are in the OFF position. Make sure that there are no other 2.4G devices in the area.
5. Each person will have to sync their ZIP™ individually at a different time to avoid interference. Follow steps 1 to 3 above making sure that no one else is syncing at the same time.
6. After syncing a player's ZIP™, it should be left ON until all players have synced their ZIP™ quadcopters.
7. Should there be a mistake or interference, all players must turn off their controllers and ZIP™ quadcopters for up to 60 seconds and then begin the process again.

PREPARING FOR FLIGHT

- Verify that there are 2 "AA" batteries inside the remote control unit and the ZIP™ has been fully charged.
- Make sure your ZIP™ and controller are both turned on.
- Make sure to be in a large space with an open radius of at least 50 feet.
- Make sure the empty space has no obstacles and water close by. Set your ZIP™ on a clean flat surface before take-off.

DO NOT ATTEMPT TO FLY YOUR ZIP™ IF THERE IS RAIN, SNOW, HEAVY WINDS, THUNDER OR LIGHTNING OUTDOORS. IT COULD DAMAGE YOUR PRODUCT AND POSSIBLY EVEN CAUSE BODILY HARM.

FLYING TIPS

- It is recommended that you operate the ZIP™ in a wide open space. The ideal space should have a 200 foot radius.
- Parental guidance or adult supervision is suggested at all times.
- If you are flying the ZIP™ with others, make sure all spectators are behind you.
- For best performance, it is recommended that you operate the ZIP™ in zero wind conditions, as wind can greatly affect the performance of the aircraft.

RECOGNIZING THE FRONT & BACK OF THE ZIP™

Even though the ZIP™ has four rotors, there is still a "front" or forward facing direction and "back" or backwards facing direction. The front and forward facing direction of the ZIP™ is the side with two gray propellers (see diagram E). The rear and backwards facing of the Quadcopter is the side with two red propellers (see diagram E).

NOTE: The front of the Quadcopter displays BLUE LED lights and the back of the Quadcopter displays RED LED lights.

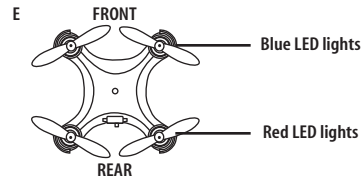

BASIC FLIGHT CONTROLS

Below is a list of basic flight functions for your long-range remote control ZIP™. While learning to fly your ZIP™ it is best to start in a large space until you get used to the basic controls. As you master flying your ZIP™ you can move to more advanced maneuvering techniques. Practice makes perfect! When you have these basic steps down you can move to the next level.

Move the left Throttle stick upwards to increase the speed of the propellers and the ZIP™ will accelerate upwards and ascend.

Move the left Throttle stick down to decrease the speed and the ZIP™ will decelerate and descend (see diagram F).

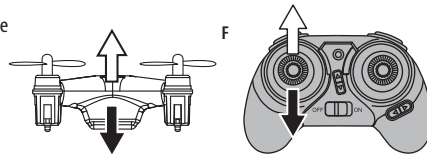

While in the air, move the left Throttle stick left and the ZIP™ will rotate left.

Move the left Throttle stick right and the ZIP™ will rotate right (see diagram G).

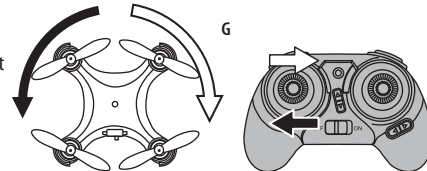

While in the air, move the right Direction Stick up and the ZIP™ will move forward.

Move the right Direction Stick down and the ZIP™ will move backward (see diagram H).

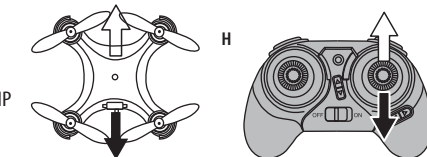

While in the air, move the right Direction Stick left and the ZIP™ will bank to the left.

Move the right Direction Stick right and the ZIP™ will bank to the right (see diagram I).

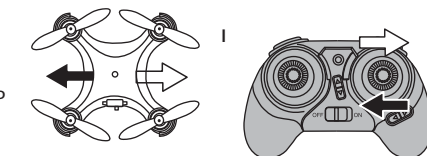

UNDERSTANDING TRIM ADJUSTMENTS

Forward/Backward Trim

- If your ZIP™ is drifting forwards or backwards, you may need to adjust the FORWARD/BACKWARD TRIM (see diagram J).
- If your ZIP™ drifts forward, push and release the BACKWARD TRIM button repeatedly until the motion stops and proper flight is maintained.
- If your ZIP™ drifts backwards, push and release the FORWARD TRIM button in the same manner until the problem is resolved.
- From time to time you may have to adjust the FORWARD or BACKWARD TRIM buttons to ensure the ZIP™ will hover in mid-air and respond accurately to your commands.

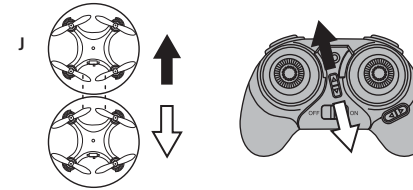

Right/Left Trim

- If your ZIP™ is drifting left or right, you may need to adjust the LEFT/RIGHT TRIM button (see diagram K).
- If your ZIP™ drifts left, push and release the RIGHT TRIM button repeatedly until the motion stops and proper flight is maintained.
- If your ZIP™ drifts right, push and release the LEFT TRIM button in the same manner until the problem is resolved.
- From time to time you may have to adjust the LEFT or RIGHT TRIM buttons to ensure the ZIP™ will hover in mid-air and respond accurately to your commands.

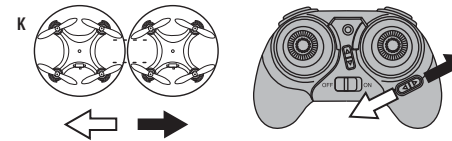

LEVEL SURFACE GYRO CALIBRATION

If the aircraft becomes unstable during the course of flying, or after a crash, you may need to recalibrate the onboard gyro chip.

To do so, place the ZIP™ on a flat level surface. Start by syncing the controller with the quadcopter. Next, pull both of the control sticks on the remote down and to the left (approximately 45°) at the same time. The LEDs on the ZIP™ will flash quickly and then remain solid. This indicates your aircraft has been stabilized (see diagram L).

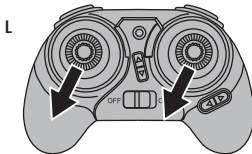

LOW BATTERY WARNING

If the power indicator LED on the remote lights up it means you are running at low voltage and need to land the aircraft slowly and replace the batteries in the controller.

If the LED lights on the quadcopter begin flashing it means you are running at low voltage and you need to land the aircraft slowly and recharge the quadcopter unit.

WARNING: Do not attempt a 360° flip when you are given a low voltage warning

SWITCHING TO HIGH SPEED MODE

To change the ZIP™'s flight speed from the default (low speed) to high speed flight mode:

1. Turn on the remote.
2. Depress the speed button on the top left side you will hear two beeps indicating your drone change to high speed mode (see diagram I).
3. To switch back to low speed press the speed button again.
4. Speed mode returns to low speed once the remote is turned off.

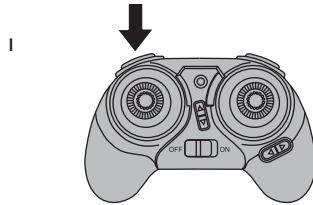

PERFORMING A 360° STUNT ROLL

Once the ZIP™ is airborne,

1. Press the 360° stunt roll button.
2. Move the lever in the direction you wish to perform the 360° roll (see diagram Q).

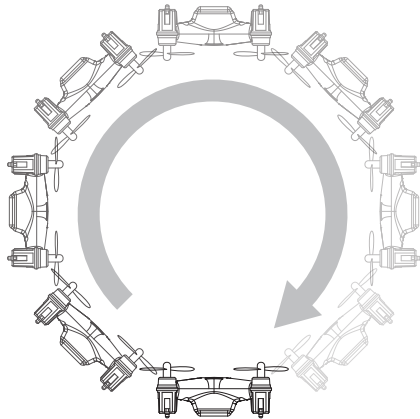
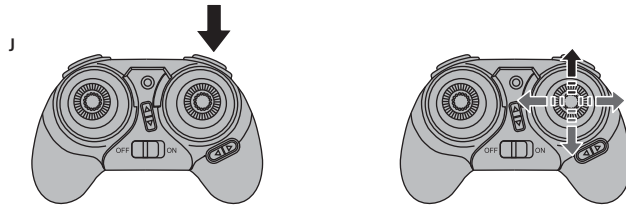

TROUBLESHOOTING YOUR ZIP™

PROBLEM	POSSIBLE REASON	SOLUTION
NO POWER	<ol style="list-style-type: none"> 1. Power switched off 2. Polarity is reversed 3. Batteries may be dead 	<ol style="list-style-type: none"> 1. Switch the ON/OFF switch to ON 2. Make sure all batteries are installed correctly (see diagram B) 3. Replace batteries
Remote Not Responding	<ol style="list-style-type: none"> 1. Remote is switched off 2. ZIP™ is switched off 3. Too windy 4. The Remote light is flashing 	<ol style="list-style-type: none"> 1. Switch the ON/OFF switch to ON 2. Switch the ON/OFF switch to ON 3. Windy conditions severely affect the operation of the ZIP™ 4. Replace batteries
Drone Won't lift off	<ol style="list-style-type: none"> 1. Rotor speed too slow 2. Drone not fully charged 	<ol style="list-style-type: none"> 1. Push throttle lever forward 2. Recharge your ZIP™
Drone Descends Too Fast	<ol style="list-style-type: none"> 1. Moving the throttle too quickly 	<ol style="list-style-type: none"> 1. Control the throttle slower and smoother
Drone Not Responding	<ol style="list-style-type: none"> 1. Gyroscopes not functioning 	<ol style="list-style-type: none"> 1. Turn on the ZIP™ and Reset the Gyros (see diagram L)
Loss of ZIP™ Control	<ol style="list-style-type: none"> 1. Drone is out of range of remote 	<ol style="list-style-type: none"> 1. Keep the drone within a 20 meter radius of the remote

REPLACING THE PROPELLER BLADES

Your ZIP™ propeller system is a precision instrument that may need repair or replacement from time to time for optimal flight function. Crash landing from high-speed aerial flights may cause damage to your ZIP™'s propellers.

1. ZIP™ have four blades, two gray propellers on the front, and two red propellers on the back. Please note that the blades and the ZIP™ are labeled with an embossed A or B (see the diagram S).
2. When replacing the propeller blades, gently remove the blade from the rotor shaft. Make sure to match both the color of the blade and the indication letter on the blade with the letter on the aircraft.
3. Replace the damaged blade with the correct blade.

Diagram S

Gray Blade Front Left = B1
 Gray Blade Front Right = A3
 Red Blade Back Left = A4
 Red Blade Back Right = B2

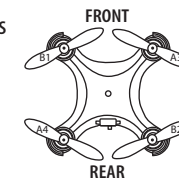

ZIP™ WARNING:

The ZIP™ is designed for INDOOR or OUTDOOR flight. ZIP™'s blades revolve at high speeds and can cause damage to the user, spectators and animals. Stand away from the ZIP™ to reduce the risk of getting into the flight path. Warn spectators that you will be flying your ZIP™ so that they are aware of its position. Before flight, inspect the rotor blades to make certain that the blades are securely fastened to the ZIP™.

WARNING!

- Choking/Cutting Hazard. Small Parts/Sharp Rotor Blades.
- Keep hands, hair and loose clothing away from the propeller when the power switch is turned to the ON position.
- Turn off the transmitter and ZIP™ power switches when not in use.
- The included charger is built specifically for the ZIP™ Li-Poly battery. Do not use it to charge any other battery.
- New alkaline batteries are recommended for maximum performance.
- Parental supervision recommended when flying ZIP™

BATTERY WARNINGS

RECHARGEABLE BATTERY:

This ZIP™ uses a Li-Poly rechargeable battery. If battery no longer stays charged, dispose of battery properly according to local disposal requirements.

CONTROLLER BATTERIES:

Remote control requires 2 "AA" batteries (not included). Please read the important battery safety warning below.

- Do not mix alkaline, standard (carbon-zinc) and rechargeable batteries (Nickel Metal Hydride).
- Do not mix old and new batteries.
- Non-rechargeable batteries are not to be recharged.
- Rechargeable batteries are to be removed from the item before being charged (if removable).
- Rechargeable batteries are only to be charged under adult supervision.
- Exhausted batteries should be removed immediately and must be recycled or disposed of properly according to state or local government ordinances and regulations.
- The supply terminals are not to be short-circuited.
- Only batteries of the same or equivalent type as recommended are to be used.
- Batteries are to be inserted with the correct polarity (see inside booklet for diagram).
- Do not dispose batteries in a fire - batteries may leak or explode.

CARE AND MAINTENANCE

- Always remove the batteries from the wireless 2.4G remote control when it is not being used for an extended period of time.
- To clean, gently wipe the remote control and ZIP™ with a clean damp cloth.
- Keep the toy away from direct heat or sunlight.
- Do not submerge the toy into water. This can damage the unit beyond repair.
- Parental guidance recommended when installing or replacing the batteries.

FCC Part 15 B Notice

CAUTION: Changes or modifications not expressly approved by the party responsible for compliance could void the user's authority to operate the equipment.

NOTE: This equipment has been tested and found to comply with the limits for a Class B digital device, pursuant to Part 15 of the FCC Rules. These limits are designed to provide reasonable protection against harmful interference in a residential installation. This equipment generates, uses and can radiate radio frequency energy and, if not installed and used in accordance with the instructions, may cause harmful interference to radio communications. However, there is no guarantee that interference will not occur in a particular installation. If this equipment does cause harmful interference to radio or television reception, which can be determined by turning the equipment off and on, the user is encouraged to try to correct the interference by one or more of the following measures:

- Reorient or relocate the receiving antenna.
- Increase the separation between the equipment and receiver.
- Connect the equipment into an outlet on a circuit different from that to which the receiver is connected.
- Consult the dealer or experienced radio/TV technician for help.

This device complies with Part 15 of the FCC Rules. Operation is subject to the following two conditions :

(1) This device may not cause harmful interference, and

(2) this device must accept any interference received, including interference that may cause undesired operation.