

FCC Part 15 C Notice

CAUTION: Changes or modifications not expressly approved by the party responsible for compliance could void the user's authority to operate the equipment.

NOTE: This equipment has been tested and found to comply with the limits for a Class B digital device, pursuant to Part 15 of the FCC Rules. These limits are designed to provide reasonable protection against harmful interference in a residential installation. This equipment generates, uses and can radiate radio frequency energy and, if not installed and used in accordance with the instructions, may cause harmful interference to radio communications. However, there is no guarantee that interference will not occur in a particular installation. If this equipment does cause harmful interference to radio or television reception, which can be determined by turning the equipment off and on, the user is encouraged to try to correct the interference by one or more of the following measures:

- Reorient or relocate the receiving antenna.
- Increase the separation between the equipment and receiver.
- Connect the equipment into an outlet on a circuit different from that to which the receiver is connected.
- Consult the dealer or experienced radio/TV technician for help.

This device complies with Part 15 of the FCC Rules. Operation is subject to the following two conditions :

- (1) This device may not cause harmful interference, and
- (2) this device must accept any interference received, including interference that may cause undesired operation.

INDUSTRY CANADA NOTICE: CANADA ONLY.

This device complies with Industry Canada licence-exempt RSS standard(s). Operation is subject to the following two conditions:

- (1) this device may not cause interference, and
- (2) this device must accept any interference, including interference that may cause undesired operation of the device.

Le présent appareil est conforme aux CNR d'Industrie Canada applicables aux appareils radio exempts de licence. L'exploitation est autorisée aux deux conditions suivantes : (1) l'appareil ne doit pas produire de brouillage, et (2) l'utilisateur de l'appareil doit accepter tout brouillage radioélectrique subi, même si le brouillage est susceptible d'en compromettre le fonctionnement.



Conforms to safety requirements of ASTM, CPSIA and FCC .

©2016 Rooftop Brands™ All rights reserved
Tel: + (1) 949-566-9573 • www.propelrc.com

Made in China

NEUTRON™ + HD CAMERA
2.4Ghz Indoor/Outdoor Quad Rotor Helicopter



INSTRUCTION BOOKLET

WARNING: Never leave product charging unattended for extended periods of time. Always disconnect Neutron™ from charger immediately after the Neutron™ is fully charged. Please refer to enclosed safety instructions.

PACKAGE CONTAINS:



Neutron



2.4G Wireless Controller



Spare Parts



Instruction Booklet

Colors and styles may slightly vary.

TABLE OF CONTENTS

Features.....	2
Remote Battery Installation.....	2
Charging the Neutron™ Battery.....	2
Neutron™ Battery Installation.....	2
Neutron™ Diagram, Remote Diagram.....	3
Syncing Your Neutron™.....	4
Preparing For Flight.....	4
Flying Tips.....	4
Recognizing the Front and Back of the Quadcopter.....	5
Forward / Backward Trim.....	5
Banking Left / Right Trim.....	6
3/4 Channel Select.....	6
Speed & Light button.....	6
4 Channel Flight Control.....	7
3 Channel Flight Control.....	7
360° Stunt rolls.....	9
Using Your on Board Camera And Video Recorder.....	10
Formatting Your Micro SD Card.....	10
Taking Digital Photos.....	10
Recording Videos.....	10
Removing Your Micro SD Card.....	11
Downloading and Clearing Space on Your Micro SD Card.....	11
Replacing The Propeller Blade.....	12
Battery Warnings, Care and Maintenance.....	12
FCC Part 15 C Notice.....	13

Thank you for purchasing the Neutron™ 2.4Ghz Indoor/Outdoor Quadcopter. Please read this instruction booklet as it contains valuable information on how to properly fly and care for your Neutron™.

FEATURES

- Built in 6 axis gyroscopic chip keeps the Neutron™ extremely stable in all conditions.
- 4 channel flight controls allow for incredible maneuverability including 360° aerial stunts!
- LED directional lights makes the Neutron™ easy to follow.
- Unique Switch-Blade technology allows you to operate in either 3ch or 4ch modes for beginner to advanced pilots
- Records video footage on Micro SD cards
- Takes still photos

REMOTE CONTROL BATTERY INSTALLATION

1. Unscrew and slide off the battery cover from the back of the controller.
2. Install 2 “AAA” alkaline batteries into the controller as shown in diagram A
3. Replace the battery cover and secure it.
4. Turn over the controller and turn the on/off switch to the on position to check for an LED light indicator. If the indicator light turns on you have installed your batteries properly.

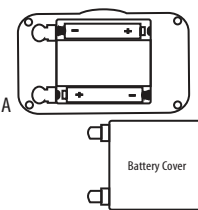

Battery Compartment
(2 “AAA” batteries)

A.

CHARGING THE NEUTRON™ LI-POLY BATTERY

1. Connect the battery to the adaptor as shown (see illustration B).
2. Next, connect the USB charging cord to your computer’s USB port (see diagram C)
Note: The Charging adaptor will show a RED charging indicator light. This lets you know that charging is in progress.
3. When the Neutron™ battery is fully charged the Charging indicator light will turn off.
4. Average charging time is approximately 30-40 minutes. A fully charged Neutron™ can fly for 6-8 minutes depending on environment and user input.

NOTE: You may purchase additional batteries and rapid wall charges at www.propelrc.com.

IMPORTANT: ALWAYS REMEMBER TO UNPLUG YOUR CHARGING CORD WHEN NOT IN USE!

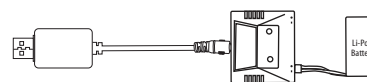

B.

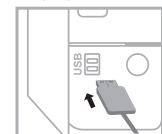

C.

NEUTRON™ BATTERY INSTALLATION

1. Slide the fully charged battery into Neutron™ battery compartment (see diagram D).
2. Connect the power cord as shown on diagram E, the quadcopter’s LED lights will light up and begin flashing when you connect the power cord correctly.
3. NOTE: The Neutron™ has no on/off switch. The Neutron™ automatically turns on when the LI-POLY battery is connected. To Switch off simply unplug the Battery

CAUTION!: NEVER FORCE THE POWER CORD: The power cord fits in only one direction, use mild constant forward pressure. If the plug seems stuck or wont move easily try turning it over and study the jack closely.

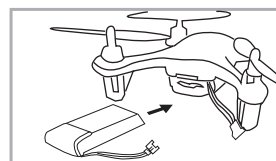

D.

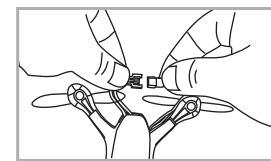

E.

NEUTRON™ DIAGRAM

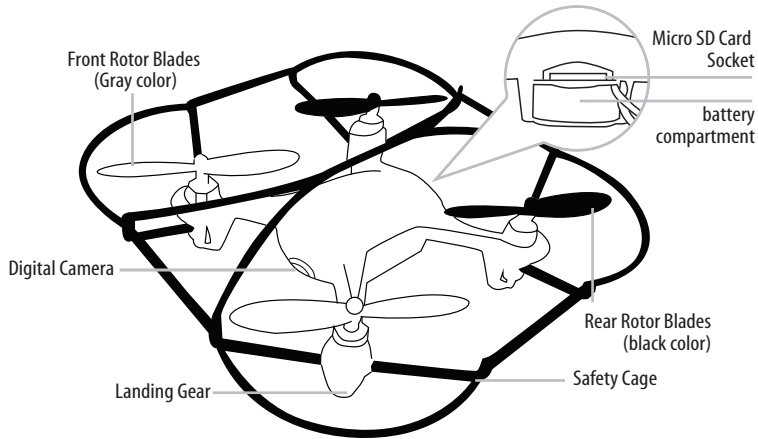

REMOTE DIAGRAM

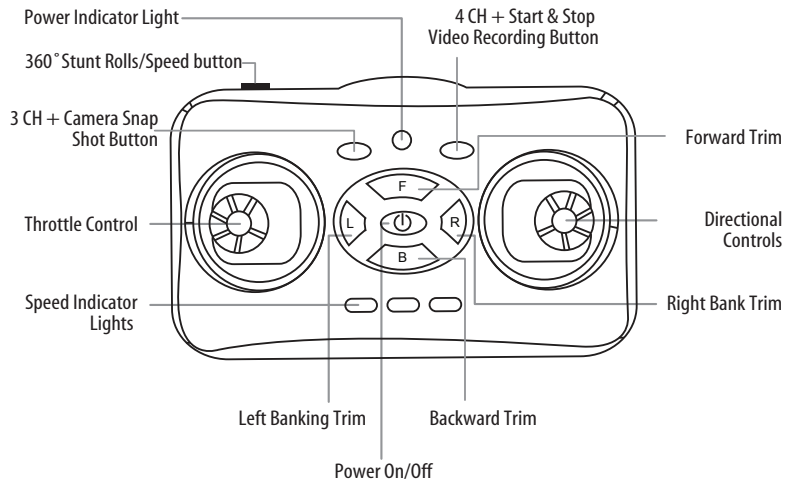

WARNING DO NOT FLY YOUR DRONE IN FOUL WEATHER!



SYNCING YOUR NEUTRON™

Important! When syncing your Neutron™ quadcopter with the controller always make sure that the quadcopter is on a flat level surface and that your digital trim settings are in the center position. This ensures that the 6 Axis gyro is properly programmed to mimic your trim settings. Your Neutron™ utilizes an automatic 2.4G channel selection system that allows up to 8 people to fly side by side in the same wireless range with no interference.

For One Person Play:

1. Before starting, make sure that the power on your controller is in the OFF position and the Neutron™'s battery is disconnected. Make sure that there are no other 2.4G devices in the area as well.
2. Connect the Neutron™'s battery and set it down on a flat surface. The white LED indicators on the top of the body should begin to flash.
3. Turn ON the remote, you will hear a dual beep, the white LED lights on the top of the drone should change to solid. Pull the throttle all the way down and then all the way up. A beep signals that your controller and the quadcopter are successfully synced. Should this not happen, repeat above steps again.

For Multi Person Play:

4. Before starting, make sure that the power on all Neutrons and Controllers are OFF. Make sure that there are no other 2.4G devices in the area as well.
5. Each person will have to sync their Neutron™ individually at a different time to avoid interference. Follow steps 1 to 3 above making sure to keep away from other people while also making sure that no one else is syncing at the same time.
6. After syncing a player's Neutron™, it should be left ON until all players have synced their quadcopters.
7. Should there be a mistake/interference, all players must turn off their controllers and quadcopters for 60 seconds and then begin the process again.

NOTE: If there is no Micro SD card inserted in the Drone, the red LED's will flash constantly.

PREPARING FOR FLIGHT

- Verify that there are 2 "AAA" batteries inside the remote control unit and the Neutron™ has been fully charged.
 - Make sure your Neutron™ and controller are both turned on.
 - Make sure to be in a large space with an open radius of at least 50 feet.
 - Make sure the empty space has no obstacles and river. Set your Neutron™ on a clean flat surface before take-off.
- DO NOT ATTEMPT TO FLY YOUR NEUTRON™ IF THERE IS RAIN, SNOW, HEAVY WINDS, THUNDER OR LIGHTNING OUTDOORS. IT COULD DAMAGE YOUR PRODUCT AND POSSIBLY EVEN CAUSE BODILY HARM.**

FLYING TIPS

- It is recommended that you operate the Neutron™ in a wide space. The ideal space should have a 200 foot radius.
- Parental guidance or adult supervision is suggested at all times.
- If you are flying the Neutron™ with others, make sure all spectators are behind you.
- For best performance, it is recommended that you operate the Neutron™ in zero wind conditions. Wind can greatly affect the performance of the Neutron™.

RECOGNIZING THE FRONT AND BACK OF THE QUADROPTER

Even though the Quadrocopter has four rotors there is still a front or "forward" facing direction and "back" or backwards facing direction. The forward Front and forward facing direction of the Quadrocopter is the side with two gray blades (see diagram F). The rear and back of the Quadrocopter is where the charging socket and the two black propellers (see diagram F).

NOTE: The front of the Quadrocopter displays **WHITE LED lights** and the back of the Quadrocopter displays **RED LED lights**.

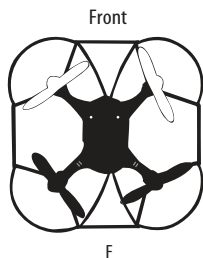

UNDERSTANDING TRIM ADJUSTMENTS

Forward/Backward Trim

- If your Neutron™ is moving forwards or backwards automatically, you may need to adjust the FORWARD/BACKWARD TRIM buttons.
- If your Neutron™ flies forward, push and release the BACKWARD TRIM (B) button repeatedly until the moving stops and proper flight is maintained.
- If your Neutron™ flies backwards, push and release the FORWARD TRIM (F) button in the same manner until the problem is resolved.
- From time to time you may have to adjust the FORWARD or BACKWARD TRIM buttons to ensure the Neutron™ will hover in mid-air and respond accurately to your commands.

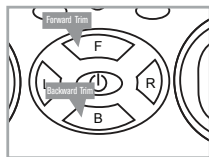

Forward/Backward Trim Controls

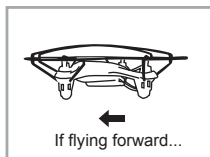

B Push and release to go backward

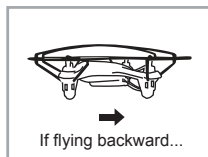

F Push and release to go forward

Banking Left/Right Trim

- If your Neutron™ is not steadily hovering and is banking to the left or right automatically, you may need to adjust the LEFT BANK or RIGHT BANK Trim buttons.
- If your Neutron™ banks to the left, push and release the RIGHT BANK TRIM (R) button repeatedly until the banking stops and proper flight is maintained.
- If your Neutron™ banks to the right, push and release the LEFT BANK TRIM (L) button in the same manner until the problem is resolved.
- From time to time you may have to adjust the LEFT and RIGHT BANK TRIM to ensure the Neutron™ will steadily hover in mid-air and respond accurately to your commands.

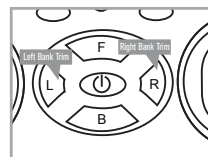

Left/Right Banking Controls

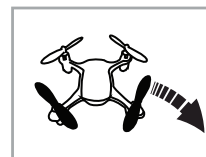

L Push the left button to increase left banking sensitivity

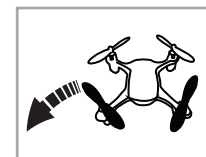

R Push to right button to increase right banking sensitivity

NOTE: The use of the Trim buttons are accompanied with a Beep tone. A single long Beep indicates the product is center trimmed. Continuous long Beeps indicate the product is trimmed to the maximum on a particular side.

3/4 CHANNEL SELECT

Neutron™ allows you to control your Quadrocopter in 3 channel mode (beginner) or 4 channel mode (advanced flying). The Neutron™ default setting is 4 Channel mode.

To change to 3 Channel mode:

PRESS and hold the 3CH button (see remote diagram on pg 3), you will hear 3 short beeps indicating the Neutron™ now is set to 3CH mode.

To change back to 4 Channel mode:

PRESS and hold the 4CH button (see remote diagram on pg 3), you will hear 4 short beeps indicating the Neutron™ is now set to 4CH mode.

SPEED SELECT BUTTON

The Neutron™ has 3 speed settings; **SLOW**, **MEDIUM** and **HIGH**. The Default setting when you first turn on your Neutron™ is the **SLOW** speed mode. To increase the speed simply depress the speed setting button (see diagram G) You will here a beep and the speed setting indicator light bar will display the current speed setting with the number of lights that are lit-up (see diagram H). One light indicates slow speed, 2 lights indicates medium speed and all 3 lights lit up indicate high or fastest speed.

NOTE: When in 3CH mode, the speed setting indicator bar will light its LEDs from Left to Right (see diagram H). When in 4CH mode the speed setting indicator bar will light it's LED's from Right to Left (see diagram I) This is a helpful reminder as to what control channel mode you are flying in.

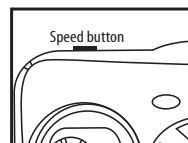

G

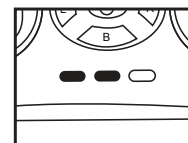

H

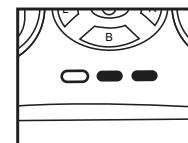

I

4 CHANNEL FLIGHT CONTROL

Below is a list of basic flight functions for your long-range remote control Neutron™. While learning to fly your Neutron™ it is best to start with a large space until you get used to the basic controls. As you master flying your Neutron™ you can move to more advanced maneuvering techniques. Practice makes perfect! When you have these basic steps down you can move to the next level.



Move the left Throttle stick up to increase the speed and the Neutron™ will accelerate and ascend.



Move the left Throttle stick down to decrease the speed and the Neutron™ will decelerate and descend.

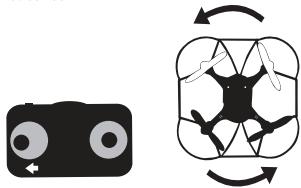

Move the left Throttle stick left and the Neutron™ will turn/spin left.

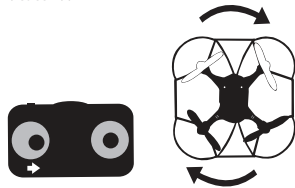

Move the left Throttle stick right and the Neutron™ will turn/spin right.



Move the right Direction Stick up and the Neutron™ will move forward.



Move the right Direction Control down and the Neutron™ will move backward.

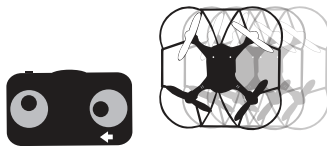

Move the right Direction Control left and the Neutron™ will bank to the left.

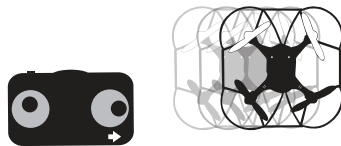

Move the right Direction Control right and the Neutron™ will bank to the right.

3 CHANNEL FLIGHT CONTROL

Below is a list of basic flight functions for your long-range remote control Neutron™. While learning to fly your Neutron™ it is best to start with a large space until you get used to the basic controls. As you master flying your Neutron™ you can move to more advanced maneuvering techniques. Practice makes perfect! When you have these basic steps down you can move to the next level.



Move the Left Throttle Stick up to increase the speed and the Neutron™ will accelerate.



Move the Left Throttle Stick down to decrease the speed and the Neutron™ will descend.

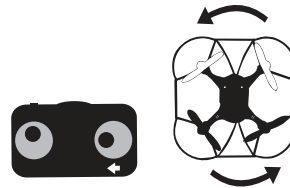

Move the Right Directional Stick LEFT to spin/turn left

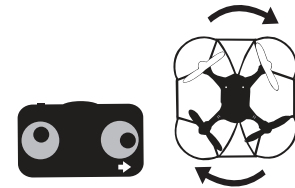

Move the right directional stick RIGHT to spin/turn Right



Move the Right Direction Stick forwards and the Neutron™ will move forward.



Move the Right Direction Stick backwards down and the Neutron™ will move backwards.

HOW TO DO 360° STUNT ROLLS

Doing 360° stunt rolls with the Neutron™ Quadcopter is as easy as 1-2-3:

1. Hover the quadcopter in still position making sure that you have at least 3 feet of clearance above and below quadcopter.
2. Press down and hold the 360 stunt button and you will enter the stunt roll mode which is indicated by a rapid beeping (see diagram J).
3. Decide which direction you want it to flip and quickly push the right control stick in the direction you want to flip your Quadcopter(SEE Diagram K). You have 4 choices a) Forward Roll, b) Backwards roll, c) right side roll, d) left side roll.

IMPORTANT NOTICE: You must hold down the stunt button as you flip your helicopter.

- 4). To exit the Stunt Rolls mode, simply release the button and push the directional control stick in any direction.

360° Stunt Rolls/Speed button

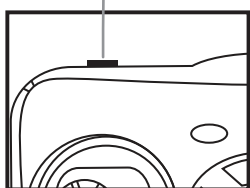

J

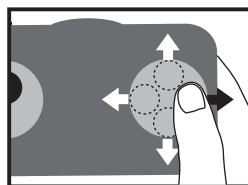

K

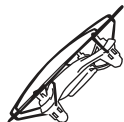

USING YOUR ON BOARD HD CAMERA AND VIDEO RECORDER

Your NEUTRON™ comes equipped with an onboard digital camera that takes both video and still Photographs. Now you can have hours of fun creating aerial photography and videos for family and friends.

WHAT YOU WILL NEED TO GET STARTED USING YOUR CAMERA

1. One Micro SD card (not included)
2. One Micro SD card reader (included)
3. One Computer with USB port and Windows Media Player or other Media player that can play AVI files (not included).

FORMATTING YOUR MICRO SD CARD

Before you can begin to take videos or digital photographs you must first format your Micro SD card. To format your Micro SD card simply place the Micro SD card into the included USB card reader and plug it into your computers USB port (See diagram 1 and 2 below). After a few moments an icon will appear on your Desktop. Right click on the Icon and follow instructions to format your Micro SD card.

INSTALLING THE MICRO SD CARD IN YOUR NEUTRON™ QUADROPTER

- Disconnect the power cord between the battery and quadcopter.
- Place the formatted micro SD card into the back of the quadcopter's digital camera port. (see diagram 3 below) Push gently and consistently until you hear and feel the micro SD card "click" into the digital camera slot.
- Reconnect the quadcopter battery and make sure that it is both fully charged and properly synced to the Controller (see HOW TO SYNC YOUR DRONE on page 4).
- When you have successfully installed your micro SD card and your quadcopter is powered up, you will see solid red LED lights on the quadcopter belly.

NOTE: If you see a continuous rapid flashing light this means you have not installed your Micro SD card correctly or there is a problem with your card. If this happens first make sure that the product is not in Video Record mode and if not then please reformat and try again. If you continue to encounter problems call our customers service line at 949.566.9573 Ext 1 for assistance.

TAKING DIGITAL PHOTOS

To take photographs simply press and release the PHOTO button on the face of the controller (refer to CONTROLLER DIAGRAM on pg. 3), when you push the button you will here a "beep" and the red LED tail lights will flash one time indicating that a picture has been taken. When the camera ready light becomes solid again you are ready for your next photograph.

RECORDING VIDEOS

To record a video first make sure that your quadcopter is fully charged and that you have correctly installed the micro SD card in the quadcopters camera port. Begin recording a video by pressing the VIDEO RECORD button on the face of the controller (see CONTROLLER DIAGRAM on page 3). the red LED tail lights on the neutron will flash constantly to indicate that you are in video mode and the camera is recording. To stop the video recording, press the RECORD button a second time. The red indicator light on the belly of the camera will change to solid indicating that video recording has stopped and the Camera is in ready mode again.

IMPORTANT NOTICE : You can not take photos and videos at the same time. When you are in video mode your camera/ photo button is disabled. If you want to take photos you must first turn off video mode.

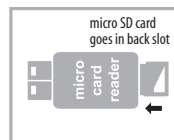

Diagram 1

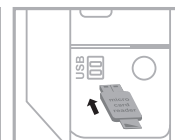

Diagram 2

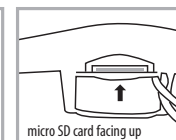

Diagram 3



Diagram 4

REMOVING YOUR MICRO SD CARD

To remove your Micro SD Card push in gently on the back of the card with your thumb or forefinger until you hear and feel a “clicking sound”. The Micro SD card will “pop out” slightly and is ready for removal. Simply grab and pull gently away from the quadcopter camera port to remove the card. Always store your Micro SD card in a clean, safe and cool environment.

DOWNLOADING AND CLEARING SPACE ON YOUR MICRO SD CARD

Plug your micro SD card into micro SD card reader and connect to your computer. It is best to always download all your videos and pictures on to your computer and not store this data on your Micro SD card. After downloading your photos and videos, follow your computers instructions to “delete” files on your Micro SD card.

IMPORTANT NOTICE: When your Micro SD card is full the indicator light on the bottom of your quadcopter will not flashing when you press the photographs or video record button. This indicates that its time put a new SD card in your quadcopter or download files and clear space for future photos and videos.

REPLACING THE PROPELLER BLADE

Your Neutron™ propeller system is a precision instrument that may need repair or replacement from time to time for optimal flight function. Crash landing from high-speed aerial flights may cause damage to your Neutron™ propellers.

1. The Neutron™ has four blades, two gray colors on front, and two black colors on back (see the diagram L).
2. When replacing the propeller blades, make sure to match both the color of the blade and the indication letter on the blade.
3. To replace the blade, gently pull off the broken blade and snap the new correct blade in place by pushing down firmly.

Gray Blade Front Left = F
Gray Blade Front Right = R
Black Blade Back Left = R
Black Blade Back Right = F

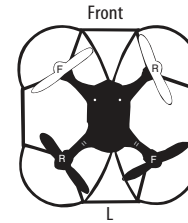

NEUTRON™ WARNING:

The Neutron™ is designed for INDOOR or OUTDOOR. The Neutron™ blades revolve at high speeds and can cause damage to the user, spectators and animals. Stand away from the Neutron™ to reduce the risk of getting into the flight path. Warn spectators that you will be flying your Neutron™ so that they are aware of its position. Before flight, inspect the rotor blades to make certain that the blades are securely fastened to the Neutron™.

WARNING!

- Choking/Cutting Hazard. Small Parts/Sharp Rotor Blades.
- Keep hands, hair and loose clothing away from the propeller when the power switch is turned to the ON position.
- Turn off the transmitter and Neutron™ power switches when not in use.
- The included charger is built specifically for the Neutron™ Li-Poly battery. Do not use it to charge any other battery.
- New alkaline batteries are recommended for maximum performance.
- Parental supervision recommended when flying Neutron™.

BATTERY WARNINGS

RECHARGEABLE BATTERY:

This Neutron™ uses a Li-Poly rechargeable battery. If battery no longer stays charged, dispose of battery properly according to local disposal requirements.

CONTROLLER BATTERIES:

Remote control requires 2 “AAA” batteries (not included). Please read the important battery safety warning below.

- Do not mix alkaline, standard (carbon-zinc) and rechargeable batteries (Nickel Metal Hydride).
- Do not mix old and new batteries.
- Non-rechargeable batteries are not to be recharged.
- Rechargeable batteries are to be removed from the item before being charged (if removable).
- Rechargeable batteries are only to be charged under adult supervision.
- Exhausted batteries should be removed immediately and must be recycled or disposed of properly according to state or local government ordinances and regulations.
- The supply terminals are not to be short-circuited.
- Only batteries of the same or equivalent type as recommended are to be used.
- Batteries are to be inserted with the correct polarity (see inside booklet for diagram).
- Do not dispose batteries in a fire - batteries may leak or explode.

CARE AND MAINTENANCE

- Always remove the batteries from the wireless infrared remote control when it is not being used for an extended period of time.
- To clean, gently wipe the remote control and Neutron™ with a clean damp cloth.
- Keep the toy away from direct heat or sunlight.
- Do not submerge the toy into water. This can damage the unit beyond repair.
- Parental guidance recommended when installing or replacing the batteries.