

ROLLER SHADES

Standard Installation Instructions



IMPORTANT: To prevent accidental damage to fabric, **DO NOT** open or cut the packaging around your shade with a utility knife or razor blade.

1) Mount the Brackets

If the clutch is on the right end of the shade, attach the brackets to the window frame, window molding, wall or ceiling, as shown below. If the clutch is on the left end of the shade, reverse the bracket positions, left for right.

To the Inside of the window frame

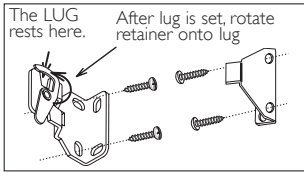

To the wall or to the front of the window molding

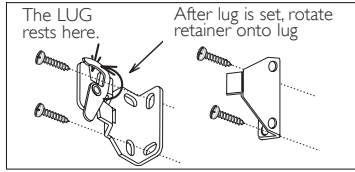

To the ceiling or to the top of the window frame

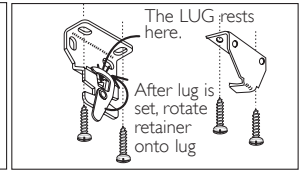

2) Install the Shade

a. Push the clutch straight onto the blade of its bracket. The bottom of the clutch should always point straight down.

b. Lower the lug of the end plug onto the "V" of its bracket. The roller should fit in the brackets securely, with just 1/8" of play. Rotate the riveted retainer portion to lock the lug in position.

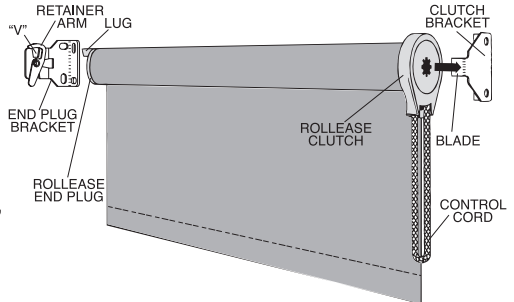

3) Install the Tension Device

The tension device reduces the hazards of strangulation and entanglement of young children and pets by limiting access to the control cord. Anchor the tension device that is attached to the shade's control cord to the window frame or wall so that young children or pets cannot pull the cord around their necks.



a. Lower the shade.

b. Position the tension device on the window frame or the wall so that the tension device and control cord do not interfere with raising or lowering the shade. The tension device should be installed without stretching or pulling down on the control cord. Stretching the cord will cause excessive wear. Do not twist or cross the control cord. If using stop balls, position the tension device 1/4" higher to allow the stop ball to pass thru the tension device.

c. Holding the tension device upright and in position, insert and secure the screws through the holes. **IMPORTANT:** Use wall anchors if the mounting screws will not be secured into a wood stud. For metal surfaces, use sheet metal screws.

4) Use the Control Cord to Operate the Shade

Pulling gently on the cord loop in one direction raises the shade; pulling it in the other direction lowers it. Using the cord loop, lower the window shade to the full drop.

SLOWLY Raise the shade slowly and observe how the fabric winds on the roll. If you notice the material winds unevenly and begins to track or telescope to one side check to insure that the shade is level. If the shade is not level, shim or reinstall the brackets, as necessary.

IMPORTANT NOTE: Operating a shade that is not level will result in damage to the material. Damage caused by operating an unlevelled shade is not covered under our normal warranty.

5) Attach Stops to a Control Cord that's made of Bead Chain

On metal bead chain, attach a metal stop ball that is at least 5/16" in diameter, so that it touches the mouth of the clutch when the shade is in the all-rolled-up position. For metal or plastic bead chain, lower the shade to sill or floor height, and attach the appropriate metal stop or plastic connector next to the clutch, this prevents the shade from being lowered beyond that point.

Cassette System Installation

1) Mount the Brackets

Mount the brackets to the wall or window frame, with the outside brackets no further than 2" (5 cm) from the ends of the headrail. On wide shades, space the additional bracket(s) at equal intervals.

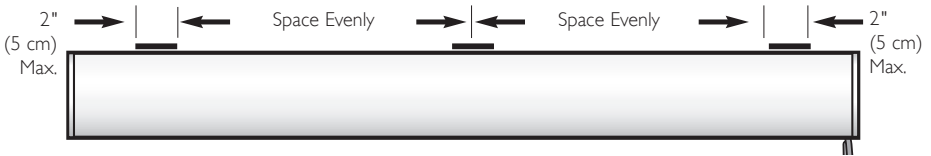

For wall or outside mounts, use the rear bracket holes.

Make sure the release tab is always mounted on the bottom.

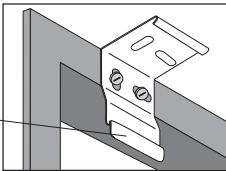

For inside or ceiling mounts, use the top bracket holes.

Make sure the release tab is always mounted on the bottom.

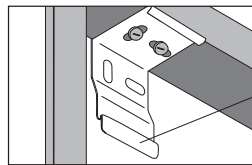

2) Mount the Headrail

Position the headrail with the front panel (A) resting on the top lip of all brackets. Push the bottom front of the headrail firmly backwards and toward the window until the lip on the rear of the headrail engages the bracket and snaps into place, (B) as shown.

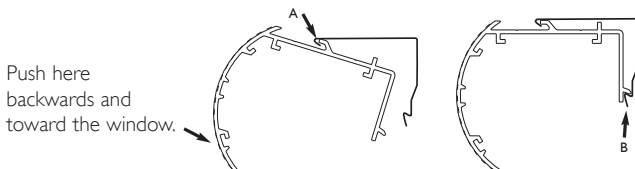

Follow steps 3, 4 and 5 found on page 1 and above to complete the installation.

Fascia Panel Installation

1) Mount the Brackets

The open end of each bracket faces downward, as shown in the drawing below. NOTE: If you have an inside mount and must use inside mount holes, you may have to drill your own holes in the side of the bracket. Use at least two screws per bracket, and make sure that the screw heads clear the clutch.

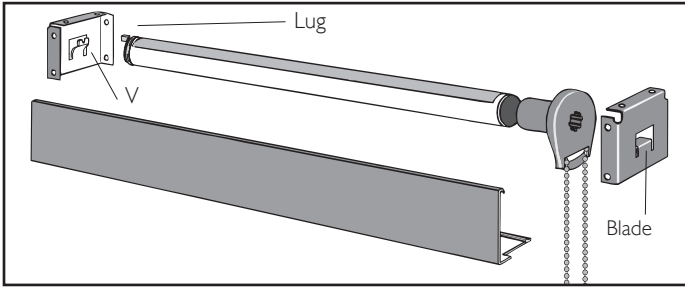

2) Install the Shade

Push the clutch straight onto the blade of its bracket. The bottom of the clutch should always point straight down, as shown in the illustration on page 3. Lower the lug of the end plug onto the V of its bracket. The roller should fit in the brackets securely, with just 1/8" of play.

ATTACH FASCIA PANEL

Attach the fascia by first hooking the top lip of the fascia panel onto the bracket as shown. Swing the bottom of the fascia panel towards the bracket and gently press at the bottom of the panel until the lip on the fascia engages and snaps lock to the bracket.

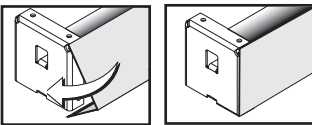

3) Attach Stops to Metal or Plastic Bead Chain

For plastic bead chain, use connector for top stop and attach another connector for lower stop. For metal bead chain, attach a metal stop ball at least 5/16" (8 mm) in diameter so that it touches the clutch when the shade is rolled all the way up. For both kinds of bead chain, lower the shade to sill or floor height, and snap the appropriate metal stop or plastic connector on the opposite side from the stop, so that the shade cannot be lowered beyond that point.

4) Install the Tension Device

See page 1 for detailed instructions on tension device installation.

5) Use the Control Cord to Operate the Shade

See page 2 for detailed information on operating your shade.

Troubleshooting Tips:

Shade is rolling up on tube unevenly or tracks

If you notice the material winds unevenly and begins to track or telescope to one side check to insure that the shade is level. If the shade is not level, remove it from the mounting brackets and shim or reinstall the brackets, as necessary.

IMPORTANT NOTE: Operating a shade that is not level will result in damage to the material. Damage caused by operating an unlevel shade is not covered under our normal warranty.



WARNING



Cords on window covering products present a potential strangulation hazard.



For child safety, consider cordless alternatives or products with inaccessible cords.



ADVERTENCIA



Las cuerdas y cadenas y persianas presentan un peligro de estrangulación.



Para la seguridad de los niños, considere alternativas sin cuerdas o productos con cuerdas y cadenas inaccesibles.

- Young children can STRANGLE in cord loops. They can also wrap cords around their necks and STRANGLE.
- Always keep cords out of reach of children
- Move cribs, playpens and other furniture away from cords. Children can climb furniture to get to cords.
- Attached the cord tensioner on the cord loop to the wall or window casement. This can prevent children from pulling cord loops around their necks.
- For the window covering to operate properly, the cord tensioner must be correctly mounted and secured, as explained in these instructions.
- Only supplied hardware should be used.