

# UV-C purification Lamp

## 254nm GermAwayUV UVC Panel Light Sanitizer

### Product Description

This product has the functions of purification and LED lighting, among which UVC internal air is eliminated. The Forced convection of built-in compulsory fan increases the efficiency of purification the air per unit time. The led lighting has 1-5 gearshift (20%/40%/60%/80%/100%) dimming options, and 1-3 gears (3000k)/4000k/5000k) color temperature adjustment.

### The theory and purification factors

Ultraviolet wavelength: 254NM

Purification principle: Use UVC to send out the wave band to destroy the DNA and RNA structure of bacteria and viruses to get a bactericidal effect.

Application: The product is suitable for purification and lighting of indoor public places such as medical institutions, schools, offices, commercial places, food industry, pharmaceutical industry ETC...

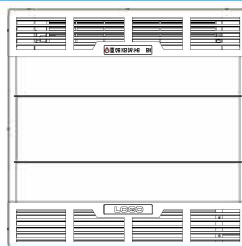

### Control operation and LCD screen display instructions

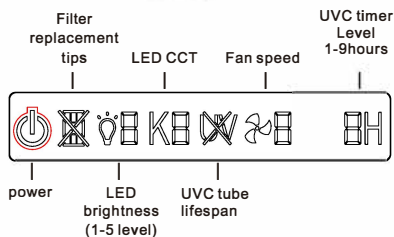
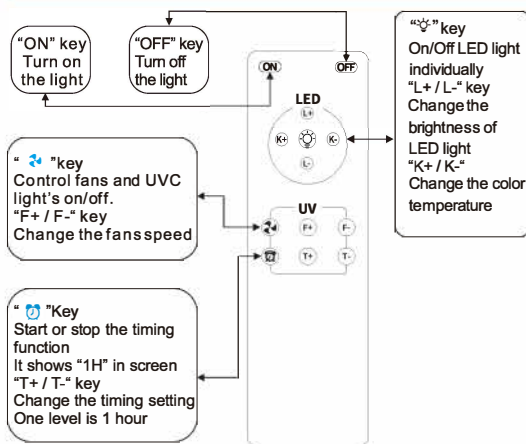

#### Electronic screen display symbol function description

	Press "ON" to turn it on and it will keep on, prompting to power on, and it will disappear when pressing "OFF".
	Normally, it is always off, and it prompts to replace the filter when flashing (countdown to 2500H)
	Turn on the LED lighting mode, and display the brightness of the LED $\checkmark$ 1- $\checkmark$ 5. The symbol disappears when the LED lighting mode is turned off.
	Turn on the LED lighting mode, and display the LED color temperature K1~K3. The symbol disappears when the LED lighting mode is turned off.
	It is not displayed when it is normal, and when the display is on, it is recommended to replace the lamp.
	Turn on the UVC ultraviolet purification mode, and display the fan speed $\checkmark$ 1- $\checkmark$ 3. This symbol disappears when the UVC ultraviolet purification mode function is turned off
	It is not displayed when it is normal, and it is displayed when the timing mode is turned on, and the timing number "1H" changes with the adjustment of the remote control, and 1 gear is equal to 1 hour.

Function description of Remote control button	
ON	The fixture is turned on and the screen displays "☰"
OFF	The fixture is turned off and the screen doesn't display "☰"
☺	When individually switch the LED, the default LED is on, and the LED control symbol K is displayed on the screen at the same time "☺".
L+	Increase the brightness of LED light, and the screen displays "☺1-☺5", ☺1=20%, ☺2=40%, ☺3=60%, ☺4=80%, ☺5=100%, and no cycle adjustment is allowed; after the brightness reaches 5 levels, it cannot be adjusted again.
L-	Reduce the brightness of LED light, and the screen displays "☺1-☺5", ☺1=20%, ☺2=40%, ☺3=60%, ☺4=80%, ☺5=100%, and no cycle adjustment is allowed; after the brightness reaches 1 levels, it cannot be adjusted again.
K+	Increase the color temperature of LED light, and the screen displays "K1~K3". K1=CCT3000K K2=CCT4000K K3=CCT5000K, no cyclic adjustment is allowed, and the color temperature cannot be increased after reaching the 3rd gear.
K-	Reduce the color temperature of LED light, and the screen displays "K1~K3". K1=CCT3000K K2=CCT4000K K3=CCT5000K, no cyclic adjustment is allowed, and can't lower the color temperature after reaching the first gear.
☼	Control the turning on and off of the UV lamp and fan. The factory default state is on.
F+	The fan speed increases, and the screen displays "☼1-☼3" at the same time, and no cyclic adjustment is allowed. After the speed is adjusted to gear 3, it cannot be increased.
F-	The fan speed decreases, and the screen displays "☼1-☼3" at the same time, and no cyclic adjustment is allowed. After the speed is adjusted to gear 1, it cannot be decreased.
🕒	Turn on or off the UV timing mode, and the screen displays the timing "1H" at the same time.
T+	Increase the timing duration, and the screen displays "1~9H" at the same time, and the timing adjustment range is 1~9, and the cycle adjustment is not allowed; it cannot be increased after the timing reaches the 9th level, and the screen displays 1H=60 minutes.
T-	Decrease the timing duration, and the screen displays "1~9H" at the same time, and the timing adjustment range is 1~9, and the cycle adjustment is not allowed; it cannot be decreased after the timing reaches the 9th level, and the screen displays 1H=60 minutes.

- Other Funtion:**
- The fixture has a button memory function. The last adjusted value will be automatically activated the next time it is started. Press any key on the remote control after pressing "ON" to turn on, and the fixture will respond with a prompt sound. In the factory default state, the LED and UV lights are turned on at the same time, and the color temperature is "K1", the LED brightness is "☺5", and the air volume is "F1".
  - The screen displays "☼" on, indicating the UV lamp needs to be replaced(countdown 5000 hours, the timing is based on the UV tube is turned on). Reset press remote control combo "☼" + "F-" to cancel the indicator symbol on the screen. If "☼" flashes on the screen, it indicates that the lamp is in poor contact or broken.
  - The screen displays "🕒" on, indicating the air filter needs to be replaced (the countdown time is 2500 hours, and the timing is base on the time when the fan starts). Reset press the remote control combo "🕒" + "T-" to cancel the indicator symbol on the screen.

## Precaution

- This remote control is compatible with 2pcs AAA1.5V batteries.

## Technical parameters of the whole lamp

Power ( W )	145W
Wavelength(nm)	254nm
Lumen ( lm )	4700(5000K)/4800(4000K)/4500(3000K)
Color Temperature(K)	3000K/4000K/5000K
Storage Temperature ( °C )	0°C~+60°C
Recommended Installation Height	≥2.1M

Remote Control Mode	Infrared Control
dimensions(mm)	595*595*142.8mm
Working Temperature ( °C )	-5°C~+40°C
Working environment humidity ( RH )	≤80%RH
Remote control detection angle	120°
Installation Method	Hanging/embedded installation

# LED Lighting Parameters

Voltage ( V AC )	Frequency ( HZ )	Power ( W )	PF	Lumen ( LM )	CCT (K)	CRI(Ra)
220~240	50/60	50	≥0.9	≥4500	3000/4000/5000	≥80

## Troubleshooting

Serial number	Failure analysis	Solution
1	No response when pressing the remote control	Please confirm whether the utility power is on/please confirm whether the battery is expired without power
2	The prompt sound, the screen does not light up	Please send it back to the original factory for repair
3	The screen is on, but the prompt does not sound	Please confirm whether the remote control has power. If there is no such situation, please return to factory for repair.
4	UVC does not light up after replacing the UVC lamp	Check whether the end of the UVC lamp tube is in full contact with the wire holder.
5	After replacing the new lamp, ✕ the symbol flashes on the screen and the lamp works normally	Please use the remote control to press the reset button ⌂+F-
6	After replacing the filter ✕ flashing	Please use the remote control to press the reset button ⌂+T-

## Light distribution curve/illuminance curve

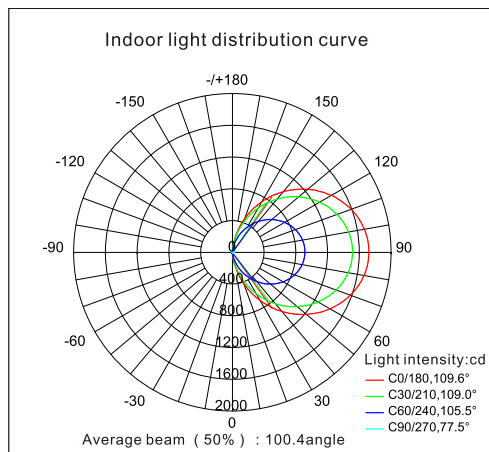

Light output : 82. 55Lm

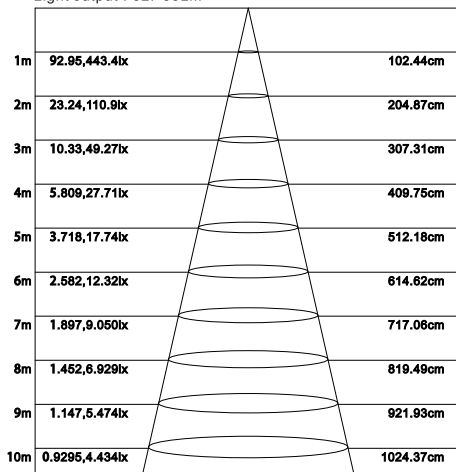

height Eavg,Emax Average beam :54.24angle diameter

Note: The curve is the illumination area and the average illuminance in the area under different projection distances.

## Reference table of air volume and purification time

Test condition: 15m <sup>3</sup> volume/20-25°C/humidity 50%-70%/ strain: Staphylococcus aureus requires purification effect to reach ≥99.9%			
Speed Gear	1gear	2gear	3gear
Time(H)	3h	2h	1h

PS: the proposed purification space for one unit is 65m<sup>3</sup> (25°C≤80%RH).

## Other attention

This product has no waterproof function, please do not install it outdoors.

This product can be used for lighting and purification.

This product can only purification the surface of the object and the air flowing bacteria, and cannot be used to purification the surface of the human body. When using this product, the surface of the ultraviolet purification should be kept clean. If there is dust or oil on the surface of the lamp, please wipe it immediately, It is recommended to wipe with a wet alcohol cloth, then wipe it dry or use a brush. Never rinse with water.

## Embedded installation instructions

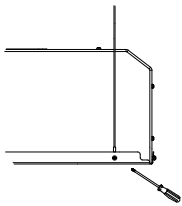

Step 1: Fasten the safety rope to the lamp body

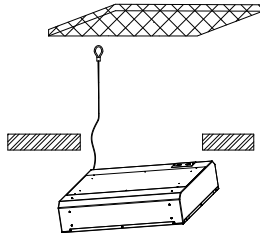

Step 2: Embed the lamp on the ceiling

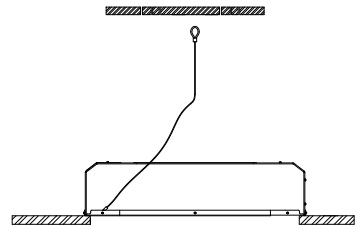

Step 3: Hang the safety rope on the ceiling; adjust and fix the lamp body and safety rope



WARNING

1. The fixture must be installed above 2.1 meters from the ground
2. Please tighten the screws when installing

## Hanging installation instructions

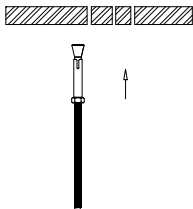

Step 1: Drill holes in the ceiling and fix one end of the boom with expansion bolts into the ceiling

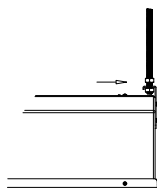

Step 2: Adjust the suspender rod and the distance between the nut position and the lamp installation accessories to buckle and assemble

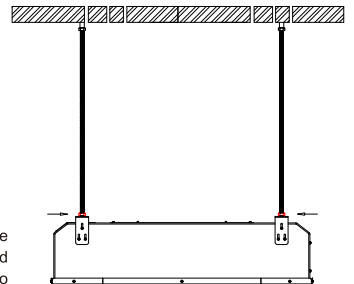

Step 3: Adjust the lamp and tighten the boom screw to fix it on the installation accessories (Remark: the threaded rod is M8)



WARNING

1. The fixture must be installed above 2.1 meters from the ground
2. Please tighten the screws when installing

## Direction of stainless steel rope installation way

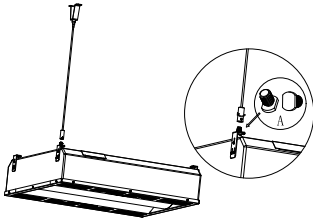

Step 1: Place the screw shown in figure A under the side of the piece and pass through the mounting piece. Tighten the wire rope and screws.

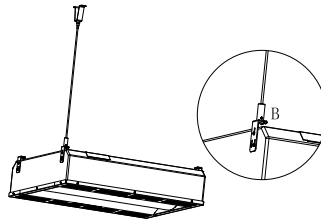

Step 2: Tighten hexagon screws shown in figure B.

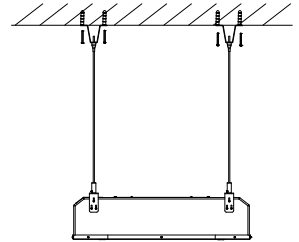

Step 3: Drill holes in the ceiling, using screws. Fix the other end of the wire rope.

## Wiring installation instructions

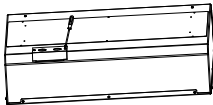

Step 1: Open the cover of the junction box.

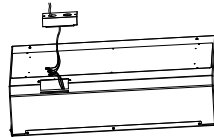

Step 2: Wiring.

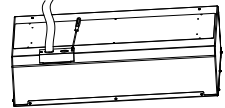

Step 3: Adjust the cable length and tighten the locking screw.

## UV-C tube replacement instructions

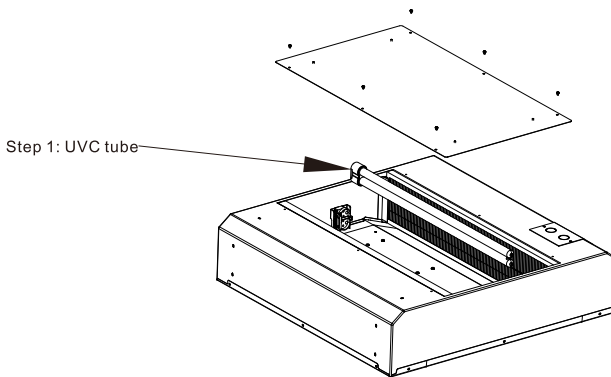

## Precautions for lamp replacement

Note: If an abnormality occurs after the replacement of the lamp tube, please refer to the troubleshooting items in this manual. Use warning: non-professionals should not open it for self-maintenance, so as not to damage the precision electronic components and the opposite side of UVC irradiation can not appear high-brightness mirror.

## Filter replacement instructions

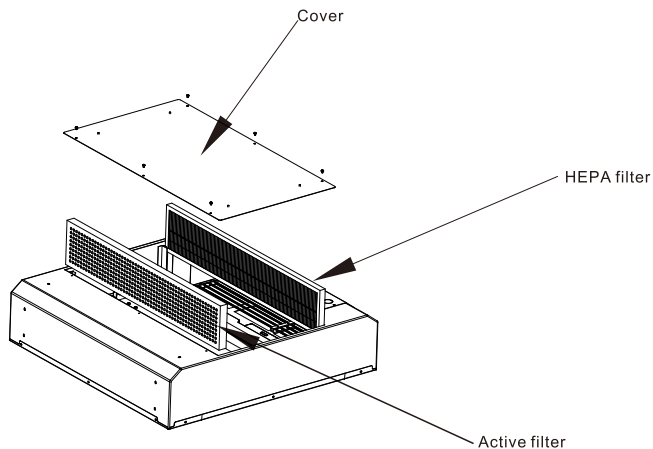

## Other attention

When using this product for indoor air purification, please close the doors and windows to keep the room clean and dry to reduce dust and moisture.

If the ultraviolet lamp is accidentally damaged, it should be ventilated in time to prevent inhalation of mercury vapor poisoning. Wear gloves or use a mercury vacuum cleaning tool to clean, do not use an ordinary vacuum cleaner. After handling the damaged lamp, please take off the protective clothing and wash your hands thoroughly before eating, smoking or using toilet supplies.

## Warranty

1. If the UVC tube of this product is damaged due to the manufacturing process, technology, components and other reasons of the product within 1 year from the date of purchase, you can get free warranty service.

2. This product is a consumable part of UVC lamp. If other components are damaged due to manufacturing process, technology, components and other product itself within 3 years of the purchase date, you can get free warranty service.

3. The free service cannot be obtained under the following circumstances:

—Exceeding the effective service or free maintenance period.

-Man-made damage caused by improper use. Such as improper installation, use not in accordance with the instructions, damage caused by incorrect use, etc. Damage caused by transportation or other accidents. Damage caused by other causes of force majeure (such as natural disasters, abnormal voltage, etc.).

—Normal product aging, wear, etc., but does not affect the normal use of the product.

—Other non-product design, technology, manufacturing, quality and other issues caused product damage.

# Disclaimer

1. The ultraviolet rays of this product cannot be used for lighting purposes and in applications or activities which may cause and or lead to death, personal or animals injury and/or damage to the environment.
2. UV-C luminaires systems must only be sold and installed and replaced by professionals according to our stringent safety and legal requirements.
3. When using this UVC product for indoor, please close the doors and windows, keep the room clean and dry, and reduce dust and moisture.
4. When UVC is irradiated on the object for a long time, it will cause irreversible damage to the object that is not UV resistant, and the object may undergo chemical or physical changes, such as the plastic items that are not UV resistant will become brittle and breakable. When using this UVC product, if there are UV-sensitive items such as oil paintings, plants, and utensils that are within the range of the upper air UV radiation, they should be covered, otherwise, they may be aged or damaged.
5. There is high efficiency UVC generating device inside. No disassemble and open it except the professionals, as it may cause injury when ultraviolet rays are directly exposed to eyes or skin. Maintenance personnel need to wear professional uv protection goggles and skin protection before repair.
6. The UVC Products are not intended for and must not be used for medical purposes.
7. In addition to and without limitation of any exclusions or limitations of liability of us as set forth in any agreement for the sale, distribution or otherwise making available of the UV-C lamp/fixture/devices, we shall have no responsibility or liability whatsoever for any claim or damage that may arise from or relate to any use of the UV-C lamp/fixture/devices outside of their intended use or contrary to their installation and operation instructions, each as described in this document, the user manuals and/or the mounting instructions.
8. The product must be designated by the manufacturer's professional and technical personnel, other personnel are not allowed to dismantle or replace without authorization.

## Warnings and Safety:

An UV-C lamp/fixture/device product breaking is extremely unlikely to have any impact on your health. If the UV-C quartz tube breaks, ventilate the room for 30 minutes and remove the parts, preferably with gloves. Put them in a sealed plastic bag and take it to your local waste facilities for recycling. Do not use a vacuum cleaner.

## Warning

1. Ultraviolet rays are harmful to humans or animals. Do not directly irradiate the skin or eyes. Please leave the irradiation sterilization area as soon as possible after lighting.
2. If you feel uncomfortable when exposed, please leave the UV light source as soon as possible.
3. In severe cases, headache, dizziness, increased body temperature, stinging eyes or poor vision. If the skin is red, swollen, itchy, and desquamated, please seek medical attention in time.

