

# UV LED Spot Cure System

HTLD-4 II



UV LED Spot Curing System User Manual

Thank you very much for buying HTLD UV LED Curing System.

Please read the product manual before you use the it .

# **Content**

- 1 Installation and connection of equipment**
- 2 Equipment basic operation and setting**
- 3 Peripheral equipment connection**
- 4 Precautions**

# 1 Installation and connection of equipment

## 1.1 Product Parts



**Controller**



**DC Adapter**



**UV LED head**



**Manual**

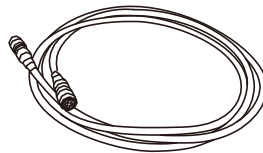

**Connection line**



**Pedal**

## 2 UV LED Curing system parts name and function:

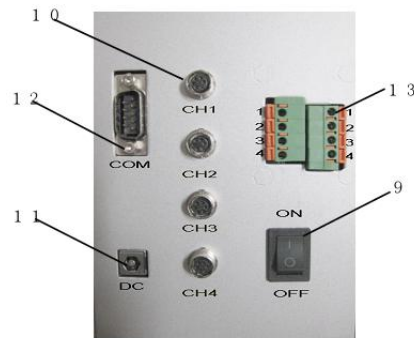

Item	Name	Function
1	Menu	Home menu display
2	Enter	Confirm selection
3	Esc	Return
4	↑ ↓ ← →	Control cursor
5	Irradiation keys (1、2、3、4)	Start or stop the UV LED Curing lamp of the corresponding channel
6	Key	Open or lock screen parameter settings

7	Total	Start or stop UV LED lamp irradiation for four channels
8	Indicator light	Detection of UV LED irradiation head normal connection or not, indication of the UV LED irradiation start or stop
9	Power	Controller power on or off
10	Irradiation head connection port (CH1/CH2/CH3/CH4)	Connect the UV LED irradiation head
11	DC socket	Connect DC power
12	RS-232C Connection (COM)	Connect peripheral communications to control the Controller
13	I/O ports	Connection of pedal or PLC programming to control the UV irradiation

## 2.1 Irradiation head connection

Connect the Lamp interface on the back of the controller with UV LED curing lamp interface, and indicator light is yellow. When unplugging, please squeeze the front half of the lamp and pull it out slightly, the indicator light is off.

## 2.2 Connection of computer signals

Connect the computer signal line with the controller COM interface

## 2.3 Connection of pedal

1-4 ports indicate the pedal ports of the 1-4 channel irradiation heads of the controller. Corresponding ports correspond to the corresponding channels. For example, port 1 has a wiring hole on the right and left respectively. Press the button , insert the cable and release the button.

## 2.4 Connection of AC adapter

Connect the AC connector to the AC interface on the back of the controller.

### 3 Equipment basic operation and setting

#### 3.1 Start and shut down

When starting up, please turn on the power, open the switch behind the controller, you can set on the controller. When Shut down, please turn off the UV LED lamp, then turn off the back of the switch, unplug the power.

#### 3.2 Functional operation

Turn on the power button , Company logo (pic 1) is appear, wait a few seconds, display the main interface: control mode set, light mode set, view set , system set , as show on pic 2.



1

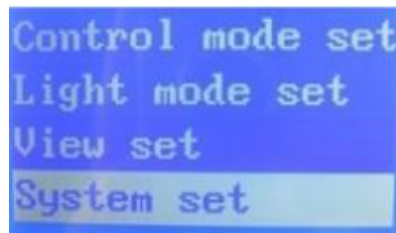

2

The parameter settings can only be performed during non-UV irradiation. You can set individual requirements by pressing “Menu + Direction Key + Enter + Esc”. Pressing the 'Esc button will return to the previous menu. Pressing the 'Menu' button will directly Return to the home menu, enter the setting state, use the '↑' '↓' button to select, use the 'Enter button to select.

**Control mode set** ——Mainly set the control mode, mainly has the following functions: total button set, one button set, pedal set .

**Light mode set**——Mainly set the light mode, mainly has the following functions: view fixed irradiation power and time set , the total time of irradiation , channel switch.

**View set**——Mainly view the parameters set for each channel.

**System set** ——Mainly setting on standby time, language, restore factory settings.

### 3.2.1 Control mode set

Pressing the "menu", select "control mode set", press "Enter" button to enter the next interface, there will be a total button set, one button set, pedal set, as shown in Pic 3 , it can be selected by the arrow keys, and press the "Enter" key to enter, as shown in Pic 4, Pic 5.



The total button set and one button set can be set valid or invalid, the Pedal set can be set by the up and down keys, manual control or Auto control. The pedal 1 controls four channels or pedals to be separated control.

The factory default settings are: the total button set is valid, the one button is valid, the foot pedal control is automatic, and discretely controlled.

### 3.2.2 Light mode set

Through the "menu" button, as shown in Pic 2, select "Light mode set", press "Enter" button to enter the next interface, there are four channel settings, as shown in Pic 6, you can use the up and down keys to select the channel, press "Enter "Enter the key as shown in Pic 7.



According to needs, you can choose "fixed power light, step power light"; The two can only choose one, "step power light" can be set in different time periods with different power to illuminate, it divided into 20 steps,the length of the time and

power intensity can be set by the arrow button and menu button.

### 3.2.2.1 Fixed power light

Select "fixed power light", press "confirm" to next interface as shown in pic 8, you can choose "view parameters, power & time set and set as valid", choose "view parameters", appear as shown in Pic 9, available to view the set parameter of this channel. choose "power & time set", as shown in Pic 10.

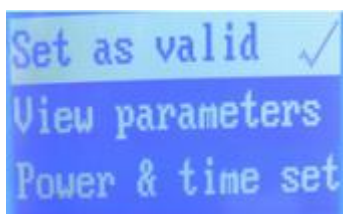

8



9

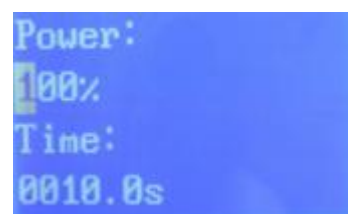

10

The cursor blinks, and the irradiation power can be set from 0 to 100% by the four direction buttons. Press the "Menu" and the up/down buttons to move the cursor to the irradiation time setting. Then press the menu or the left and right direction button, the cursor will blink, and can set the irradiation time from 0-9999.9S, finish setting, press the "enter" button to return to Pic 9. Press "Esc" again and select "Set as valid". Pic 8 appears. The setting is completed.

### 3.2.2.2 Step Power light

Same channel at the same time can only choose "fixed power light" or "step power light", If "step power light" is selected, press "Enter" to enter next interface as show on Pic 11. You can use the arrow button to enter "view parameters" as shown in Figure 12.

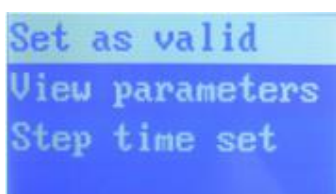

11

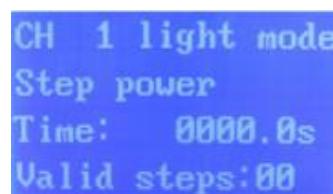

12

You can also choose “step time set” to set the power and time in each stage, show as 13,



13

You can use the “Menu”, press the “up and down, left and right” button to enter “02, 03, 04, 05” and 20 different steps to set the time and power respectively. The above setting is the same as the fixed power light setting method. Press “Enter” to return to Pic 11 and press “Set as valid”. This setting is completed.

### 3.2.2.3 Channel Switch

As shown in Pic 7, select "Channel Switch", press "Enter" , select "Open" to open the channel, select "Close" to close the channel. The other 2, 3, 4 channels can be set according to above method, just press "Menu" to return to the main interface or press the Esc to return to Pic 5, and then start the setting.

### 3.2.3 View set

Press "Menu" button, select "View Set", press "Enter" to see the irradiation parameters set in the channel 1, as shown in Figure 14, then use the up and down button to see each channel's set total irradiation parameters one by one as shown in Pic 15, 16, and 17.

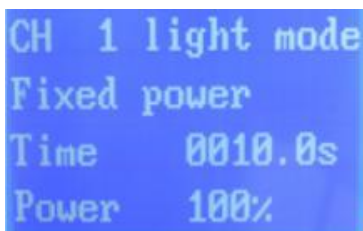

14



15



16



17



### 3.2.4 System set

In the menu interface, as shown in Pic 2, select "System Set", Pic 18 appears, Buzzer set, standby screen , language, restore set. Select "Buzzer set" and press "Enter", You can choose either "Open" or "Close". Choose "standby screen", you can select constant light or set the time independently, set the time through the arrow keys, then press the "Enter" to finish the setting. For "Language" settings, there are two languages to choose , Chinese and English, it can be set by "up and down + Enter" buttons. the factory default is English. Choose "Restore set" to enter Pic19, you can choose to OK or Cancel. This item needs to be carefully selected. once you choose, you need to reset the parameters.

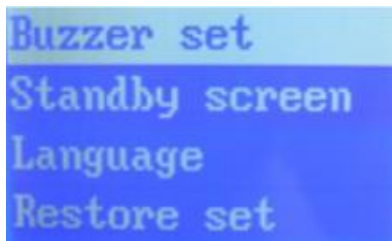

18



19

## 4 Irradiation

After the setting is completed, make sure that the required controller's head is connected and the corresponding channel indicator is bright and yellow. UV irradiation can be controlled by two ways, one is through the host panel and the total button, press the digital UV irradiation button, the indicator light turns from yellow to red, the buzzer will beep, the corresponding channel UV lamp began to work . During the process of irradiation, you can press the digital UV irradiation key to inquire about the situation of the corresponding channel irradiation, but this operation is under the premise that the channel displayed by the LCD screen is not the channel process that you want to know, this item requires careful operation, if the LCD screen has been displayed the parameters of the channel that you want to know, please do not press the channel digital button again, if press the digital UV irradiation button , the UV irradiation will stop, if the set time has expired, UV

irradiation will also stop, the indicator light turns from red to yellow, buzzer will short beep; UV irradiation can also be controlled through the total button, it can be turned on and off at the same time. The other is by Pedal switch. There are two types of Pedal control: manual control and auto control. Manual control is the process of the irradiation completely controlled by the pedal, depress and irradiate, release and stop ; When "auto control", the irradiation process is automatically performed according to the set time and mode; When the pedal 1 controls four-ways," the pedal 2,3,4 can still control the channels 2,3,4. When"respectively control", one pedal control two channels, the method is split two joints on a pedal, two parallel two series.

The "buzzer setting" has "open" and "close". When it is turned on, the buzzer will beep long once when each irradiation is started,the buzzer will beep short once when stops, and the buzzer will alarm three times when there is an error."

## **5 View irradiation parameters**

### **5.1 Inquire the irradiation process during UV irradiation**

In the UV irradiation process, active each channel one by one, start up the total irradiation ,the pedal switch,, and the irradiation starts , during the process of irradiation, you can press the digital UV irradiation key to inquire about the situation of the corresponding channel irradiation, but this operation is under the premise that the channel displayed by the LCD screen is not the channel process that you want to know, this item requires careful operation, if the LCD screen has been displayed the parameters of the channel that you want to know, please do not press the channel digital button again, if press the digital UV irradiation button , the UV irradiation will stop.

## 5.2 Non-UV process to check the parameters set for each channel

Press the "Menu" button , enter the "Light Mode Set", then enter each channel, and then view the "setting parameters of the relevant channel."

## 5.3 Total exposure time during non-UV irradiation

Press the "Menu" button to enter "light Mode Set", select any "Channel" and enter "View the total irradiation time" to see the UV irradiation time of each channel. If you need to clear, press Enter again, enter the password, according to the cursor prompt, select "Enter" one by one, clear it.

## 6 Peripheral equipment connection

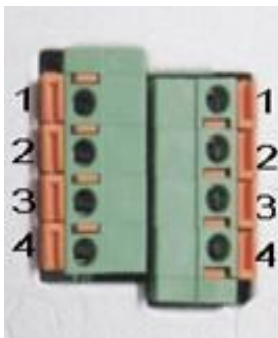

I / O signal port



COM communication port

I / O signal port is double socket, , the left row of sockets are grounded and all are connected. The right row of sockets are positive level and independent interface. 1-4 ports indicate the pedal switch ports of the 1-4 channel irradiation heads on the controller. The corresponding ports correspond to the corresponding channels. E.g, port 1 has a wiring hole respectively on left and right, press the button next to the hole to insert the root cable of the pedal respectively, and release the button. If a pedal is required to control two channels at the same time, one pedal plug can be inserted into the left row of ports, and the other pedal plug can be inserted into the corresponding port in the right row. At the same time, a line can be drawn from this port and insert the right row of channel socket that need to be lit at the same time.

E.g, port 1 on the left is connected to port 1 on the right, then port 1 on the right leads to a line and insert into port 2 on the right, under the premise that pedal control can be selected manual or automatic control, select discrete irradiation, press the pedal, then can turn on the UV lamps of channels 1 and 2 at the same time.

PLC programmer can connect IO communication ports based on positive and negative level signals.

COM communication port, RS-232 plug can be connected, you need to cooperate with the appropriate software to achieve.

## **7 Precautions**

- ( 1 ) UV LED light Do not direct eyes or skin.
- ( 2 ) Do not disassemble UV LED radiation head , it may cause UV light leakage.
- ( 3 ) To install or remove the UV LED head, be sure to turn off the power.
- ( 4 ) Do not use thinner, volatile oil, acetone, kerosene and so on when cleaning the irradiation head and controller regularly. Put a small amount of ethanol on a soft cotton cloth and carefully wipe.
- ( 5 ) please use in a cool, dry, ventilated, no high magnetic field, no high electric field environment.
- ( 6 ) Please use the power adapter factory dedicated DC power supply.
- ( 7 ) Do not open the controller privately to prevent the risk of leakage