

Technical Data Sheet

CUREUV Part No: 513009



Lamp Type: TUV-PL-L55W

| | |
|----------------------------|----------------|
| (A) Total Length: | 535mm |
| (B) Arc Length: | 490 mm |
| (C) Lamp Quartz Diameter : | 17mm Twin Tube |

| | |
|--------------------|-------|
| Operating Current: | 540mA |
| Lamp Voltage: | 103 |
| Lamp Wattage: | 55 |

| | |
|-----------------|-----------|
| Peak UV Output: | 253.7nm |
| Glass Type: | Non Ozone |

| | |
|---------------------------------|--------|
| Output UVC Watts: | 17 |
| Output uW/cm ² @ 1m: | |
| Rated Life (hrs): | 10,000 |

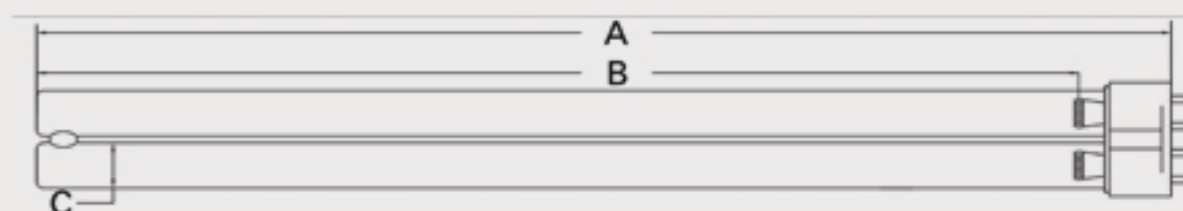
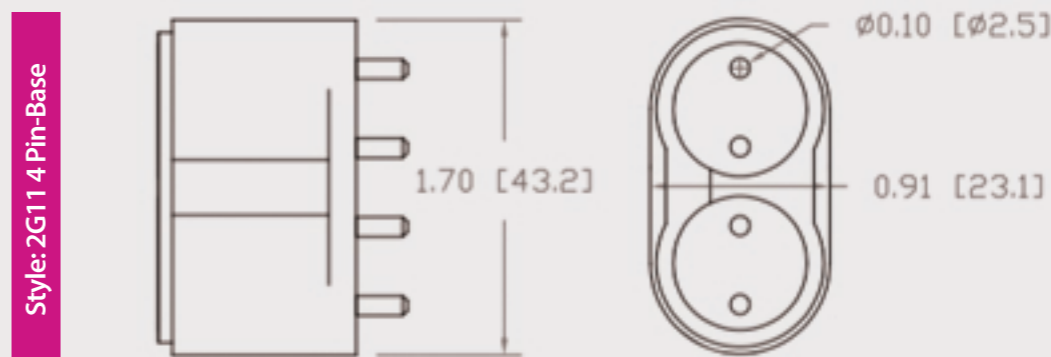

Lot Number: _____

Ignition and Seal Certification: _____

Test Operator: _____ Date: _____