

MODEL X1S1650

SPOTNAILS®
 DIVISION OF PEACE INDUSTRIES, LTD.
 1100 Hicks Rd
 Rolling Meadows, IL 60008
 Phone : 847-259-1620

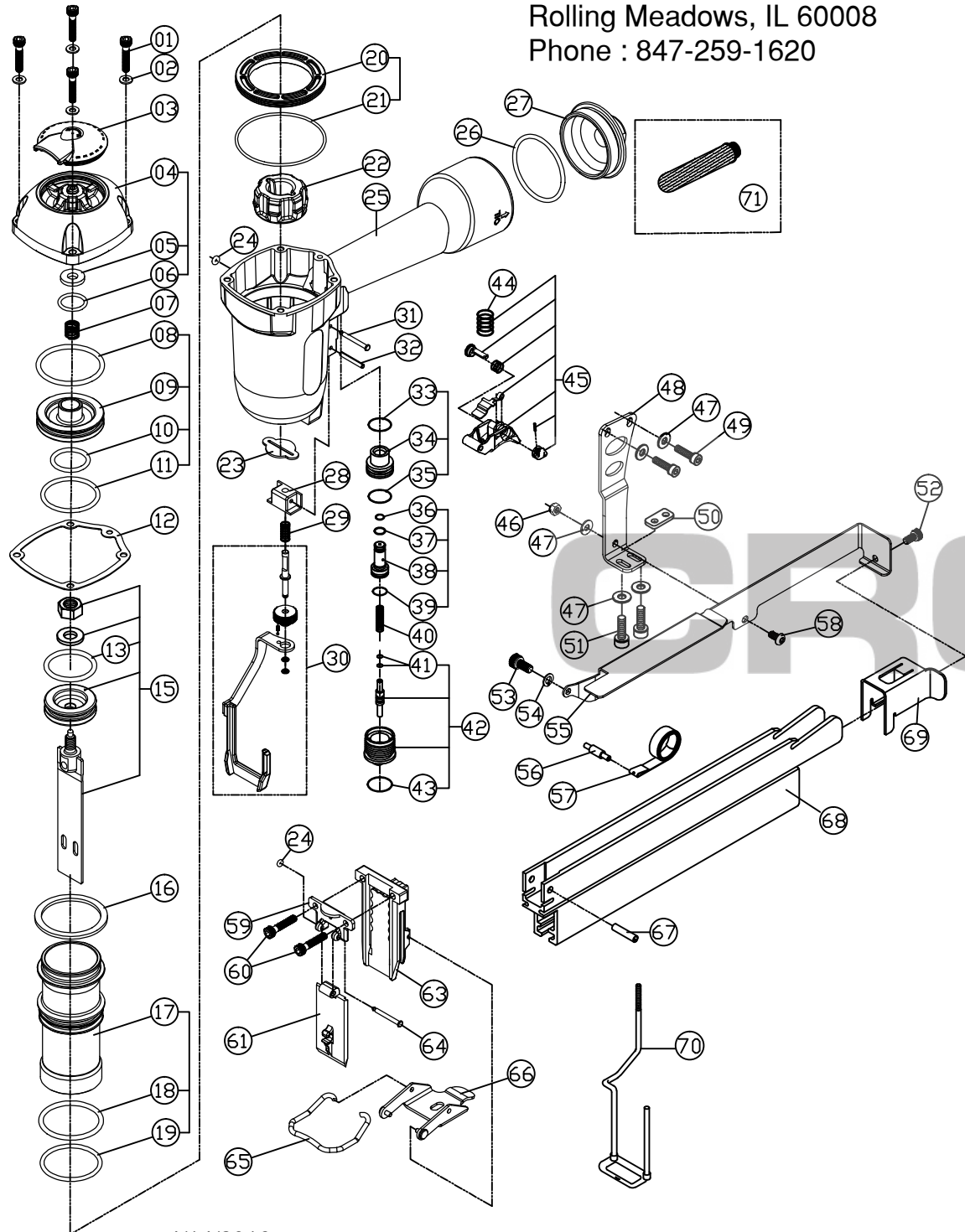

4/14/2016

SPOTNAILS MODEL X1S1650

Ref No.	Part No.	Description	Ref No.	Part No.	Description
01	P-24300	Cap Screw-4	37	P-64335	O-Ring
02	P-32211	Flat Washer-4	38	P-22145	Pilot Valve
03	P-70058	Exhaust Deflector	39	P-64336	O-Ring
04	P-60221	Cap	40	P-18227	Spring
05	P-15187	Exhaust Seal	41	P-64383	Plunger O-Rings-2
06	P-64378	O-Ring	42	AS-22037	Plunger Assembly
07	P-18327	Poppet Spring	43	P-64328	O-Ring
08	P-64601	Poppet O-Ring	44	P-18267	Spring
09	P-63055	Poppet	45	AS-21031	Trigger Assembly (Blue)
10	P-64379	Piston Stop o-Ring	46	P-26126	Nut
11	P-64602	Cylinder Seal O-Ring	47	P-32170	Washer-5
12	P-62094	Gasket	48	P-13133	Bracket
13	P-64617	Piston O-Ring	49	P-24301	Screw-2
15	AS-06110	Piston & Driver Assembly	50	P-26159	Nut Plate
16	P-03125	Guide Spacer	51	P-24308	Screw-2
17	P-05131	Cylinder	52	P-24430	Screw
18	P-64603	Cylinder O-Ring	53	P-24317	Screw
19	P-64604	O-Ring	54	P-32229	Washer
20	P-03126	Cylinder Guide	55	P-12417	Magazine Cover
21	P-64605	O-Ring	56	P-07335	Negator Spring Pin
22	P-15278	Bumper	57	P-18334	Negator Spring
23	P-15198	Return Seal	58	P-24434	Screw
24	P-64240	O-Ring-2	59	P-10285	Stationary Front Plate
25	P-01308	Body	60	P-24358	Screw-2
26	P-64312	O-Ring	61	P-10349	Removable Front Plate
27	P-60156	End Cap	63	P-08518	Wear Plate
28	P-53165	Safety Guide	64	P-07357	Pin
29	P-18328	Spring	65	P-18333	Latch Spring
30	AS-53087	Safety Assembly	66	P-04062	Quick Clear Latch
31	P-07327	Trigger Pin	67	P-07334	Pin
32	P-07262	Pin	68	P-12414	Magazine
33	P-64332	Valve Housing O-Ring	69	P-09186	Pusher
34	P-22144	Trigger Valve Cap	70	AS-53085	Lathing Safety (Optional)
35	P-64333	O-Ring	71	P-97454	Filter (Optional)
36	P-64334	O-Ring			

◆ Parts Included In AS- 97403 O-Ring And Seal Kit