

125-140 IN LBS.
OF TORQUE
(144-161 CM-KG)
4 PLACES

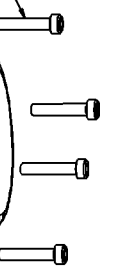

45-55 IN LBS.
OF TORQUE
(52-63 CM-KG)

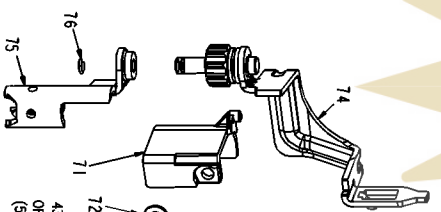
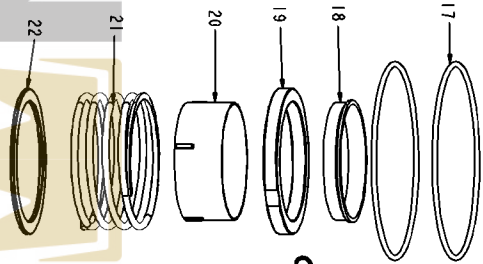
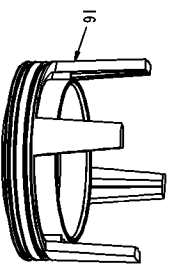
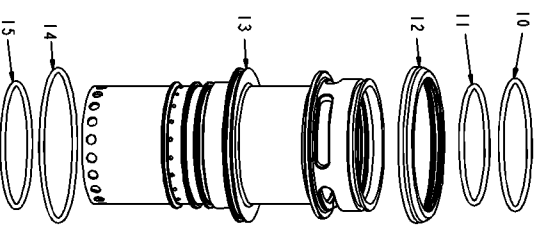
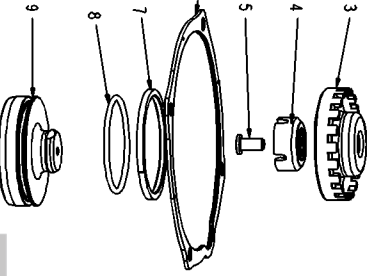

43-5 IN LBS
OF TORQUE
(50-60 CM-KG)

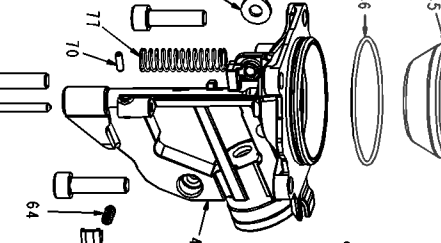

300-330 IN LBS.
OF TORQUE
(346-380 CM-KG)
4 PLACES

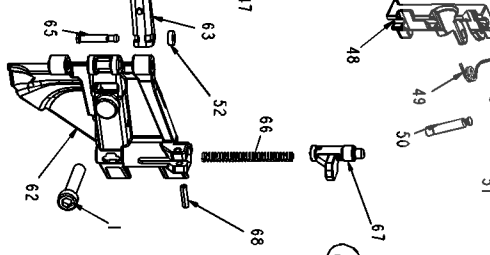
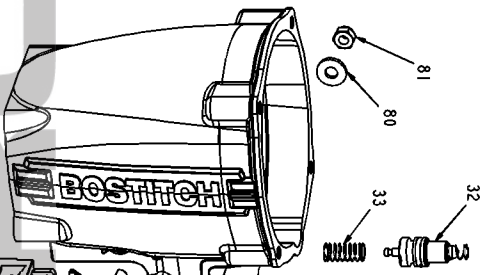
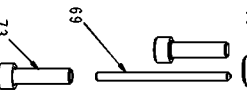

125-140 IN LBS.
OF TORQUE
(144-161 CM-KG)

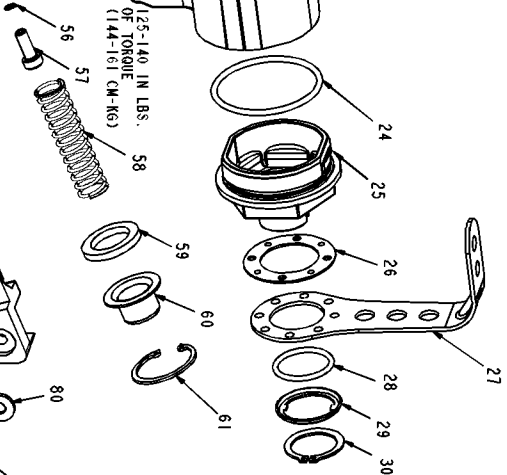

876



Parts List for BTF83C Type 0

Item Number	Part Number	Description	Qty Required
1	MSC6100-30	SCREW-SHCS-M6X1.00X3	5
2	9R198248	CAP	1
3	9R208267	EXHAUST BUTTON	1
4	9R198239	PISTON STOP	1
5	9R198240	EXHAUST SCREW	1
6	9R198252	GASKET	1
7	9R209763	PISTON RING	1
8	850242	O-RING-1.799X.103	1
9	F83C-DK	DRIVER KIT	1
10	9R209130	O-RING 63.70X2.62MM	1
11	9R209131	O-RING 57.75X2.62MM	1
12	9R208325	CYLINDER SEAL	1
13	9R208321	CYLINDER	1
14	9R209157	O-RING 75.10X2.62MM	1
15	9R209132	O-RING 61.10X2.62	1
16	9R209788	CYLINDER BULKHEAD	1
17	9R209133	O-RING 97.5X2.62MM	1
18	9R198280	CHECK SEAL	1
19	9R213407	RING RETAINER	1
20	9R215027	VIBRATION DAMPER	1
21	9R209143	CYLINDER SPRING	1
22	9R208390	BOTTOM RING	1
23	9R198249	FRAME	1
24	9R208337	O-RING 52.00X3.00MM	1
25	9R208324	END CAP	1
26	9R208291	HOOK SEAT PLATE	1
27	9R208290	HOOK	1

COPYRIGHT© 2005. All Rights Reserved.

Parts list, pricing, and availability subject to change. Please visit www.dewaltservicenet.com for current parts information.

Parts List for BTF83C Type 0

Item Number	Part Number	Description	Qty Required
28	174309	O-RING-1.049X.103	1
29	9R188812	CAP-HOOK	1
30	9R208349	C-RING 26MM EXTERNAL	1
32	TVA20	TRIGGER VALVE ASSY.	1
33	9R198242	TRIGGER SPRING	1
34	9R208350	MODE SWITCH PIN	1
35	188850	SPRING	1
36	9R208280	MODE SWITCH BUTTON	1
37	184508	BUSHING	1
38	180484	SCREW-SET-M3X8MM	1
39	9R213415	TRIGGER ASSEMBLY	1
40	174345	PIN SPRING	2
41	9R208355	ARM GUIDE	1
42	106058	PIN-SPRING-M3X32	2
43	9R209790	CONTACT ARM SPRING	1
44	9R208336	O-RING 6.80X1.90MM	1
45	F83-BK	BUMPER KIT	1
46	9R198240	EXHAUST SCREW	1
47	9R208376	NOSE F83C	1
48	9R213423	FEED PAWL, F83C	1
49	N80120	SPRING-TORSION	1
50	N50087	PIN-SPECIAL(STEP)	1
51	N80121	ROD-FEED PISTON	1
52	854004	WASHER-RUBBER-7	1
53	MRG009824	O-RING-.386X.094	1
54	N80128	PISTON-FEED	1
55	851384	O-RING-.987X.103	1

COPYRIGHT© 2005. All Rights Reserved.

Parts list, pricing, and availability subject to change. Please visit www.dewaltservicenet.com for current parts information.

Parts List for BTF83C Type 0

Item Number	Part Number	Description	Qty Required
56	LW14.2	WASHER-1/4 HI COL LO	1
57	MSC6100-16	SCREW-SHCS-M6X1.00X1	1
58	163930	SPRING-FEED PISTON	1
59	N80123	BUMPER-FEED PISTON	1
60	N80124	COVER-FEED PISTON	1
61	851383	RING-RETAINING METRI	1
62	9R198279	DOOR	1
63	9R214972	CHECK PAWL	1
64	9R214973	CHECK PAWL SPRING	1
65	N70140	PIN-SPECIAL(STEP)	1
66	854013	SPRING,CMPRSN.	1
67	N70150	LATCH DOOR	1
68	MPP030012	PIN-SPIROL	1
69	9R208375	DOOR PIN	1
70	MPG030010	PIN-ROLL-3MM X 10MM	1
71	9R213429	TRIP COVER	1
72	MPW6.2	WASHER.SPECIAL	1
73	MSC8125-30	SCREW-SHCS M8X30	4
74	9R213403	UPPER CONTACT ARM	1
75	9R208373	LOWER CONTACT F83C	1
76	9R209147	RETAINER RING	1
77	9R208377	SPRING	1
78	9R210201	CANSITER ASSEM, F83C	1
79	MSC6100-35	SCREW-SHCS-M6X1.00X3	1
80	MPW6.2	WASHER.SPECIAL	3
81	MHE6100-100	NUT-ESN M6X1	2
876	F83-RK	REBUILD KIT	1

COPYRIGHT© 2005. All Rights Reserved.

Parts list, pricing, and availability subject to change. Please visit www.dewaltservicenet.com for current parts information.