

# 450S2

## PNEUMATIC STAPLER ENGRAPADORA NEUMÁTICA AGRAFEUSE PNEUMATIQUE

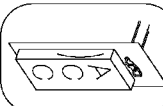
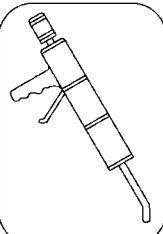
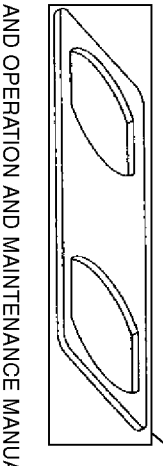
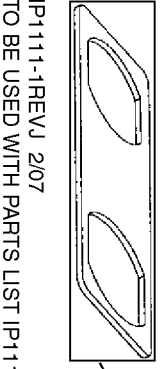
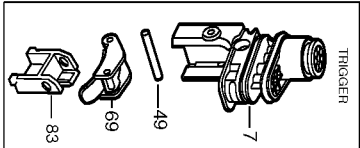
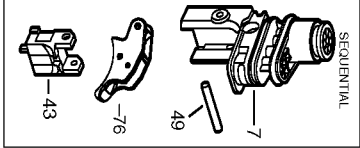
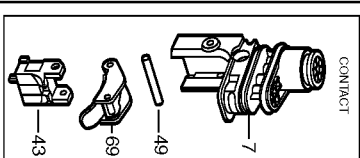
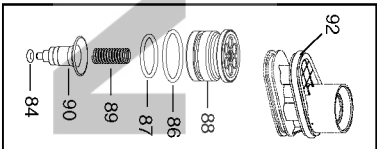
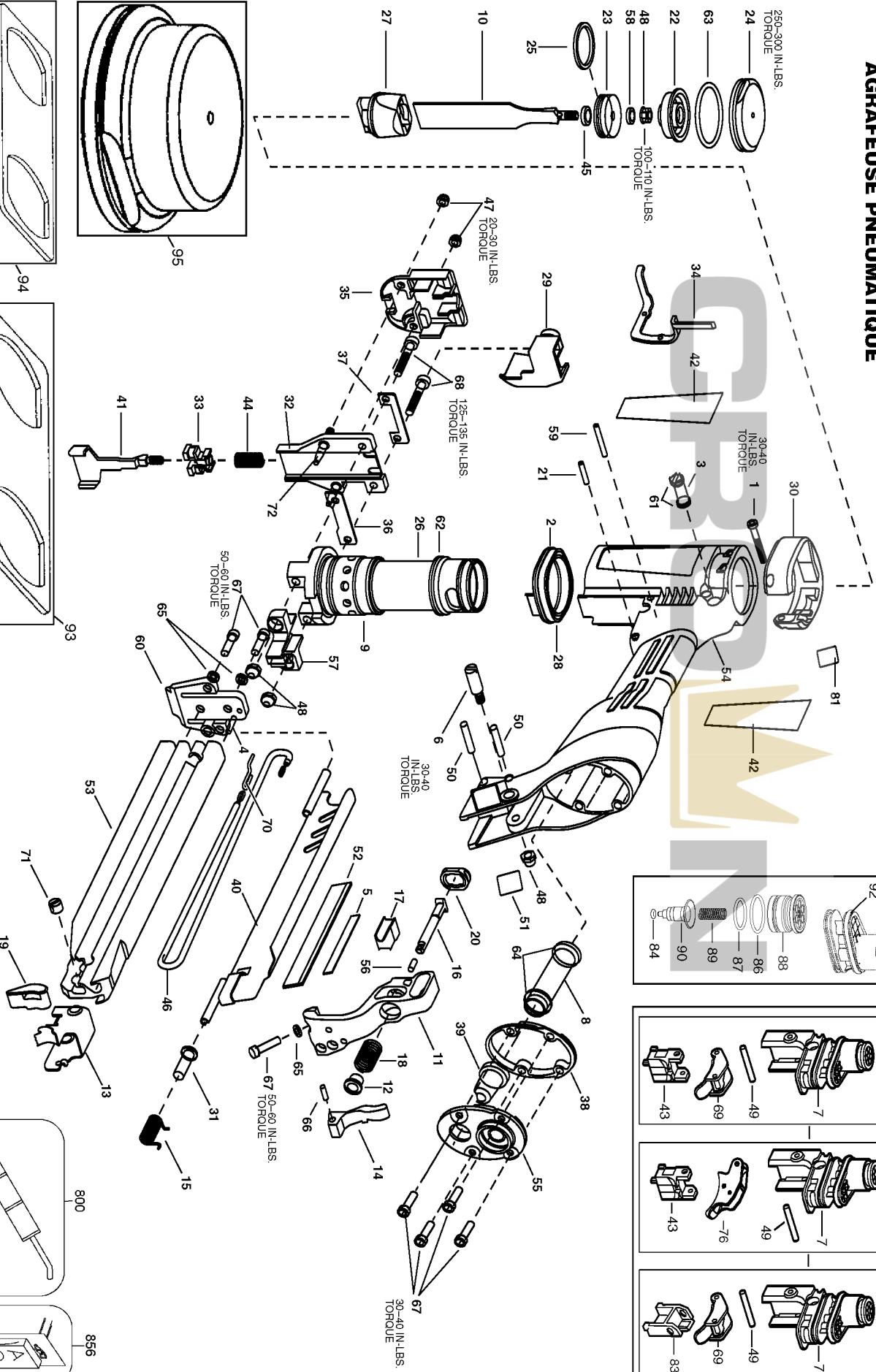

IP1111-1REVJ 2/07  
TO BE USED WITH PARTS LIST IP1111-2 AND OPERATION AND MAINTENANCE MANUAL 104000.

## Parts List for 450S2 Type 0

Item Number	Part Number	Description	Qty Required
1	100258	SCREW	1
2	100279	O-RING-1.612X.103	1
3	101525	VALVE-ENERGY CONTROL	1
4	102044	PIN-SPIROL 3MMX16MM	1
5	102166	LABEL	1
6	102168	SCREW-SPECIAL (MAGAZ	1
7	TVA12	KIT-STANDARD MODULE	1
8	103208	TUBE-EXHAUST	1
9	103211	SEAL-CHECK	1
10	103214	DRIVER-(1IN)	1
11	103217	BRACKET-MAGAZINE	1
12	103218	BUSHING-TOGGLE PIN	1
13	103222	PUSHER (1IN)	1
14	103447	TOGGLE-MAGAZINE	1
15	103549	SPRING-COVER	1
16	103558	LATCH-MAGAZINE	1
17	103601	SLEEVE-BRACKET	1
18	103770	SPRING-COMPRESSION	1
19	103791	HANDLE-PUSHER	1
20	103795	DISC-LATCH STOP	1
21	103858	PIN-SPRING-4X20MM	1
22	103993	BUMPER-TOP L/P	1
23	103994	PISTON	1
24	103995	CAP-SLEEVE L/P	1
25	166045	RING-PISTON	1
26	103997	SLEEVE-CYLINDER-L/P	1
27	103998	BUMPER-LOWER L/P (1/	1

COPYRIGHT© 2005. All Rights Reserved.

Parts list, pricing, and availability subject to change. Please visit [www.dewaltservicenet.com](http://www.dewaltservicenet.com) for current parts information.

## Parts List for 450S2 Type 0

Item Number	Part Number	Description	Qty Required
28	103999	BULKHEAD-SLEEVE - L/	1
29	104027	COVER-TRIP L/P	1
30	104064	PROTECTOR-FRONT FRAM	1
31	104067	BUSHING-MAGAZINE COV	1
32	160198	NOSE-S2	1
33	104339	ADJUSTER-TRIP	1
34	104623	ARM-UPPER CONTACT	1
35	104931	CASTING-NOSE COVER	1
36	104974	WEARPLATE (1IN)	1
37	104975	PLATE-NOSE	1
38	105057	GASKET-END CAP L/P	1
39	105070	EXHAUST DEFLECTOR	1
40	105073	COVER-MAGAZINE	1
41	105163	ARM-CONTACT	1
43	105932	ARM GUIDE ASSEMBLY	1
44	105934	SPRING-COMPRESSION	1
45	105959	WASHER-PISTON	1
46	106051	SPRING-EXTENSION	1
47	MHE5080-100	NUT-NYLON M5X.80	2
48	MHE6100-100	NUT-ESN M6X1	2
49	106058	PIN-SPRING-M3X32	1
50	106059	PIN-ROLL-M4X30MM	2
51	106097	LABEL-PATENT	1
52	158612	LABEL-WARNING	1
53	106172	ASSEMBLY-MAGAZINE-2I	1
54	166984	FRAME	1
55	106292	CAP-END L/P	1

COPYRIGHT© 2005. All Rights Reserved.

Parts list, pricing, and availability subject to change. Please visit [www.dewaltservicenet.com](http://www.dewaltservicenet.com) for current parts information.

## Parts List for 450S2 Type 0

Item Number	Part Number	Description	Qty Required
56	106334	PIN-SPIRAL 4X10MM	1
57	106474	TOP GUIDE	1
58	106691	WASHER-SPECIAL M6	1
59	106871	PIN-SPRING 4X32MM	1
60	107071	TIP-CORE (2IN)	1
61	107129	O-RING-.268X.075	2
62	850607	O-RING	1
63	850628	O-RING-1.734X.139	1
64	851554	O-RING-.703X.103	1
65	MLW5	WASHER-HSLW M5	3
66	MPG030012	PIN-SPRING-M3X12MM	1
67	MSC5080-20	SCREW-SOC HD. CAP M5	7
68	MSC6100-35	SCREW-SHCS-M6X1.00X3	2
69	CNTK2	KIT-CONTACT TRIP CON	1
70	T50078	ANCHOR-PUSHER SPRING	1
71	T60024	PIN-SPECIAL(MAG NUT)	1
72	104069	PIN-NOSE	1
76	SEQ6	KIT-SEQUENTIAL	1
81	110009	LABEL-POWER VALVE	1
83	106173	STOP-TRIGGER	1
84	105996	O-RING-.087X.059	1
86	102164	O-RING-.728X.059	1
87	102163	O-RING-.591X.059	1
88	167205	ASSEMBLY-HEAD VALVE	1
89	101540	SPRING-COMPRESSION	1
90	101533	SEAL-EXHAUST	1
91	101532-S	BOSTITCH SEAL	1

COPYRIGHT© 2005. All Rights Reserved.

Parts list, pricing, and availability subject to change. Please visit [www.dewaltservicenet.com](http://www.dewaltservicenet.com) for current parts information.

## Parts List for 450S2 Type 0

Item Number	Part Number	Description	Qty Required
92	108467	O-RING-1.237X.103	1
93	000000-00	No Longer Available	1
94	106427	WRENCH-SLEEVE CAP	1
95	112604	CAP-WEIGHT-L/P	1
800	100653	LUBE (2CC)	1
800	100679	LUBE (1LB.CAN)	1



COPYRIGHT© 2005. All Rights Reserved.

Parts list, pricing, and availability subject to change. Please visit [www.dewaltservicenet.com](http://www.dewaltservicenet.com) for current parts information.