



17+ 6.7 Powerstroke Long Bed Fuel Filter System

***** Terms used in this document- WIF (water in fuel sensor), DFCM (diesel fuel conditioning module) or lower fuel filter housing, QC (quick connect fuel lines)

*****Take care and make sure to clean everything before disassembly.

1. Disconnect the battery negative cables. Remove the factory Torx bolt for the lower water and fuel separator. Disconnect WIF sensor wiring. DO NOT drain/remove the WIF sensor or drain valve. This will only cause an extra mess.

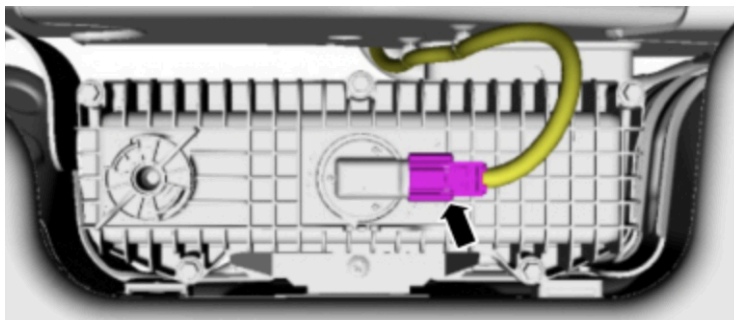
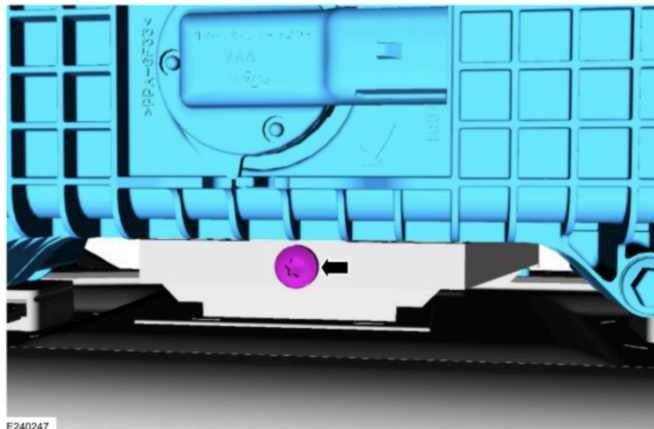

2. Push up on the fuel filter assembly to get it out of the saddle mount. Once clear, drop the assembly down as far as possible to help gain access to the top quick connect lines and disconnect them. Before disconnecting, we recommend cleaning the lines with brake clean and blowing or wiping them off. The return line (connection coming in from the side) will route differently depending on the bed size.

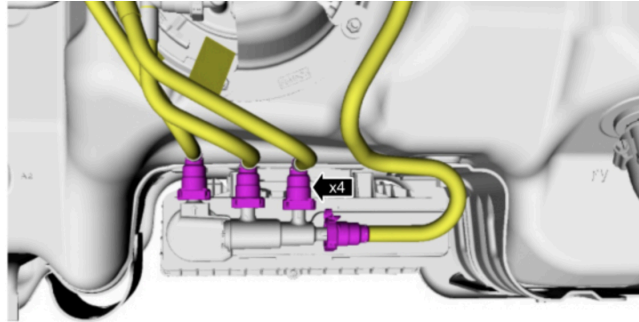

***NOTE- Here are some different types of disconnects and how to work them.

1. Release the secondary locking tab.
2. Depress the primary locking tab.
3. Separate the quick release coupling from the tube.

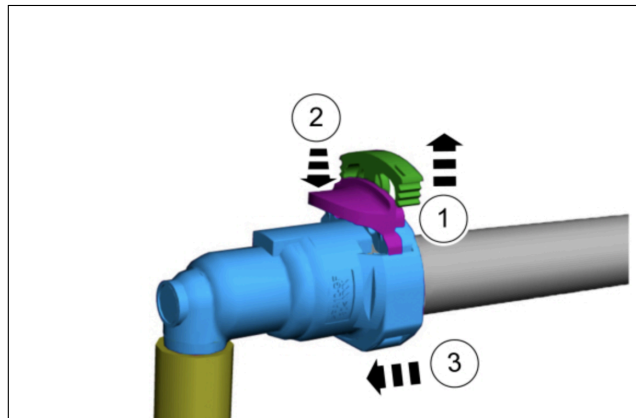

1. Release the locking tabs.
2. Pull out on the retainer clip.

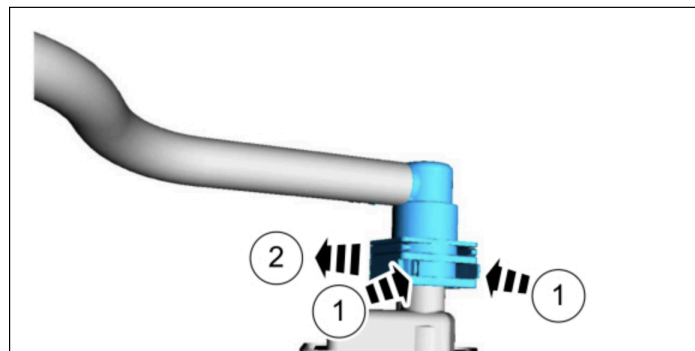

3. After disconnecting the fuel lines, remove the assembly from the truck. Once again, ensure the fuel lines are free of debris and clean. Prepare the SPE filter housing and remove the filters to make it easier to maneuver the assembly. Verify that the fitting locations are correct for your truck type (shown below). Ensure you install the matching fittings by their number designated on the fitting AND fuel filter block.

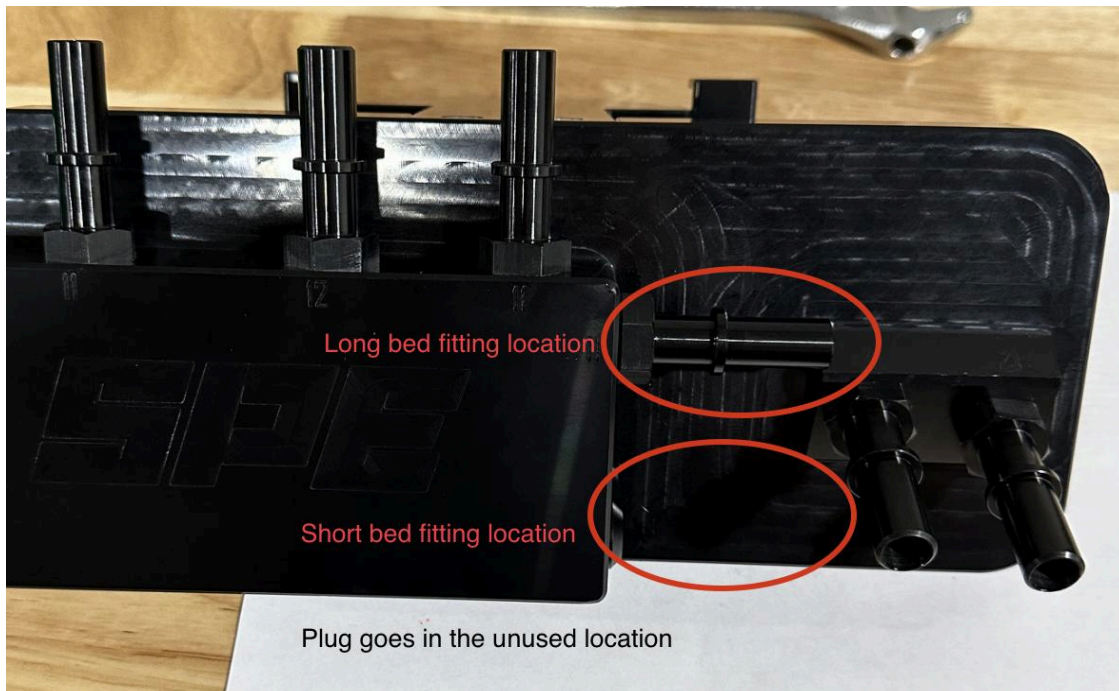
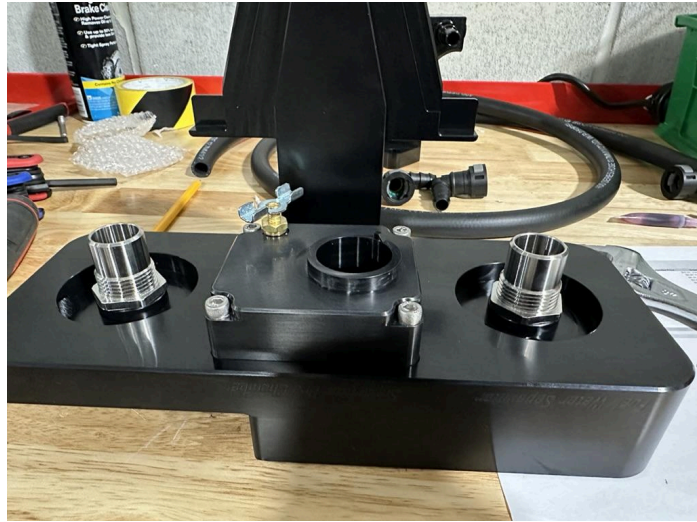

4. Remove the WIF from the factory DFCM. Install into the SPE Housing. Push in and twist, so the connector faces out and is accessible to plug in. Lift the assembly up into the truck, connect the fuel lines as shown, and install the assembly into the factory tank saddle/mount. Install the factory mounting bolt.

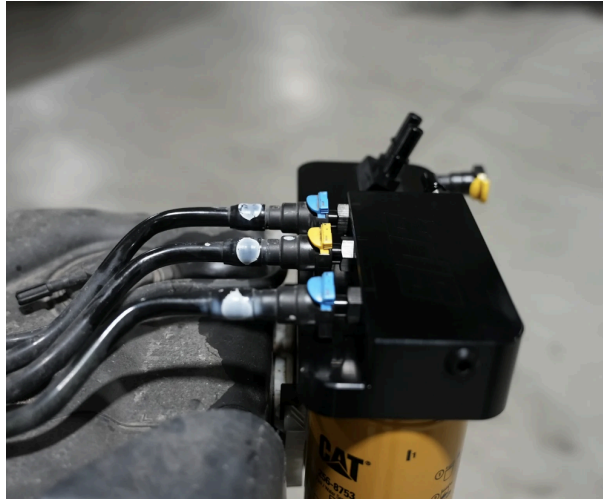

(Line connections shown out of the truck for pictures)



5. Take the two 1/2" included 6ft length fuel hoses & cut 10" off each hose. The lengths can be adjusted if desired. Install the included hose ends as shown below. Lubricate the fittings and push to install. They are a very tight fit make sure the hose is seated all the way onto the fitting. Clamps are not necessary; they are a push lock design.



Pictured below are hoses with ends installed.

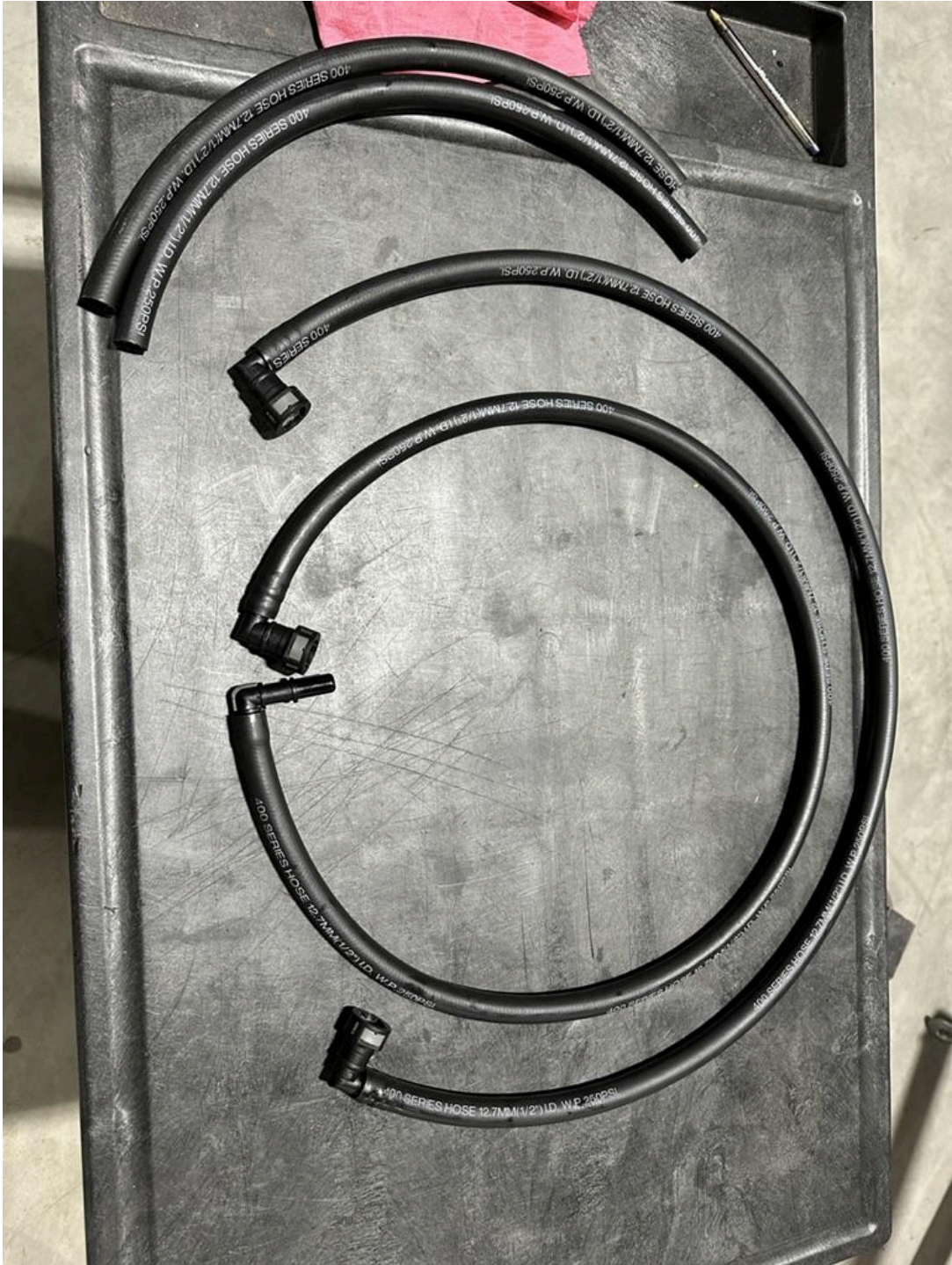

6. Disconnect the factory pressure hose at the front end of the tank circled in white. It is a QC to the hard line on the frame rail; the QC is yellow. Separate the lines. Install the new hoses as shown below. The male fitting will install in the factory QC fitting and route to the outside fitting on the housing. The other hose with 90-degree QC will connect to the male hard line and run to the center QC on the SPE housing. The hoses will go up and over the frame rail, then to the filter housing passing back over the frame. Take care not to kink the hoses. Follow the routing path as shown.

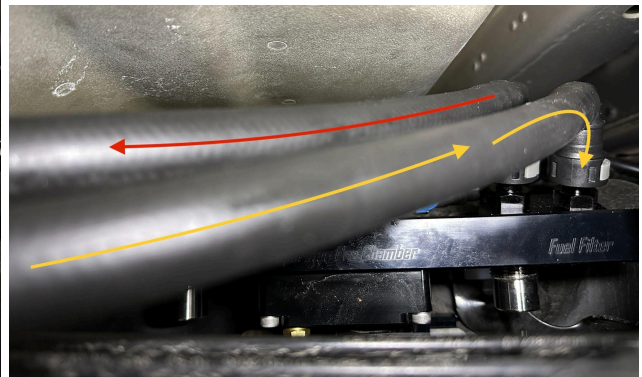
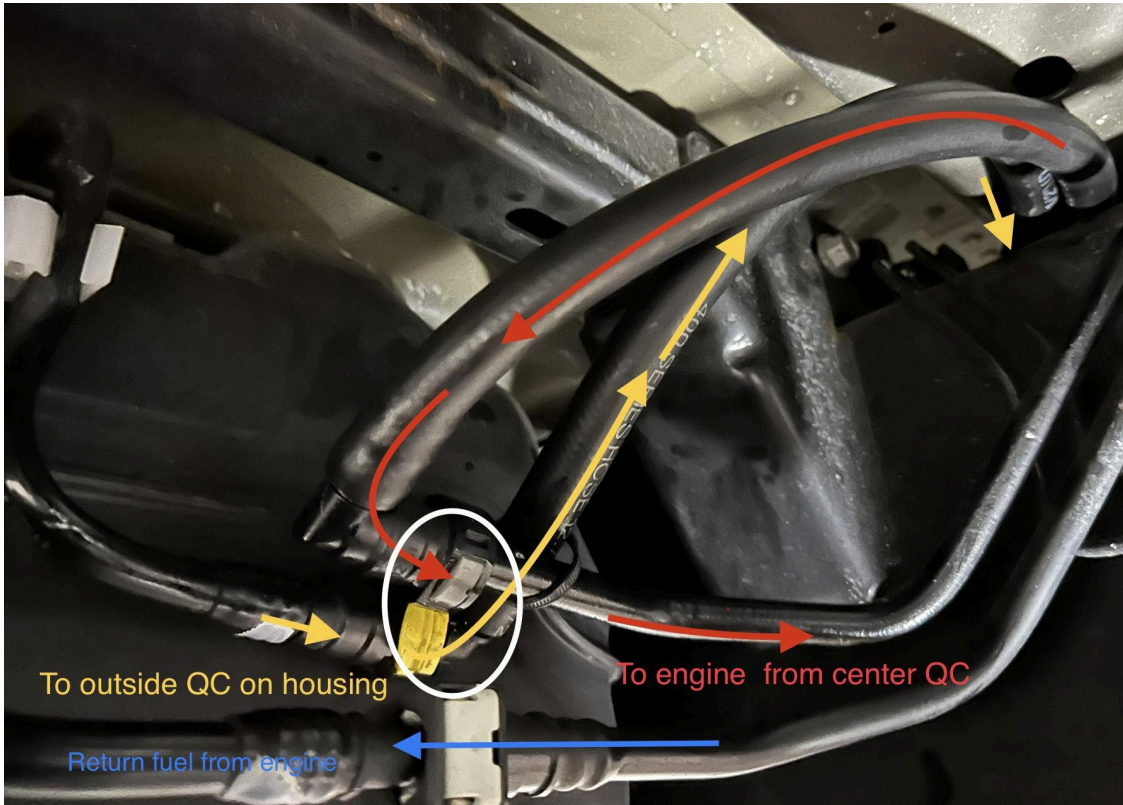

7. Connect the WIF sensor wiring, and route it up and out of the way. Check to ensure the drain valve is closed in the clockwise position and tight. Fill both filters with fresh, clean fuel. Install them in their labeled location on the housing. Make sure to install the O ring onto the water separator adapter before screwing it on. Looking at the front of the housing, the water separator goes to the left, and the 1R fuel filter to the right.



8. Remove the top filter and bracket. Remove the 8mm and 13mm bolts.

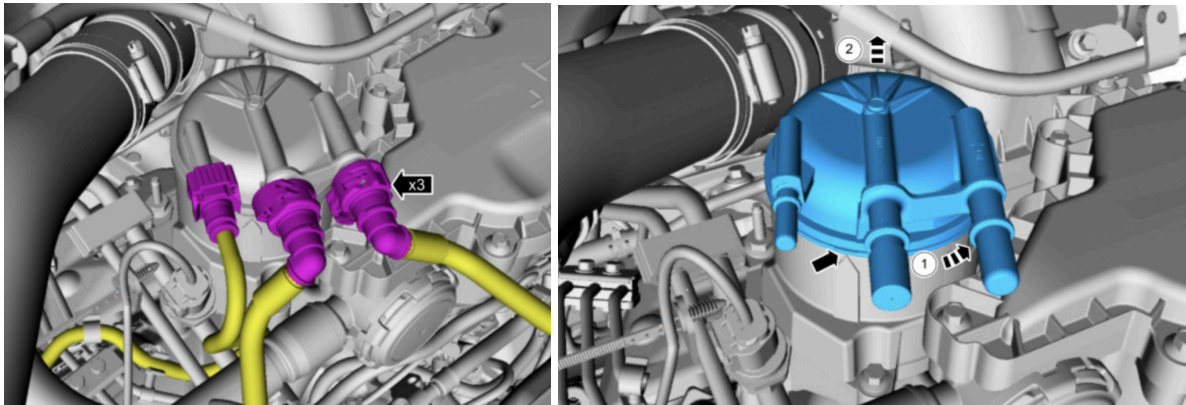



9. Install the top filter Fuel manifold in its place with the provided M6 Allen bolt. Verify the QC male fittings are in the proper position; they are all not the same size. The larger one goes closest to the firewall, we designate that as a 12. The center one is an 11. Install the factory fuel lines.



10. Reconnect the battery terminals. Turn the ignition on do not start the truck. This will allow the pump to prime, and you can check for leaks without the engine running. We recommend doing the prime/cycling the ignition a couple of times before starting the engine. The pump will usually change pitch and sound quiet when appropriately primed.

Start the engine and verify there are no leaks. Now you can enjoy great filtration, performance, and peace of mind!

****NOTE:** When using the drain valve/pet cock, turning to the right is open & left is closed. This is the opposite of the factory drain valve. Also, be careful not to over-tighten.